

INDEX

BRAKE PARTS

Caliper sealing kit	Page	2
Caliper piston kit		2
Caliper piston		2
Disc rotors		15
Mastercylinder repair kit		19
Mastercylinder reservoir rebuild kit		28
Mastercylinder reservoir cap & dia. Set		30
Caliper Pad pin set		31

CLUTCH PARTS

Clutch friction disc set		36
Clutch driven plate set		37
H.D. Clutch spring set		37
Clutch mastercylinder repair kit		37
Clutch slave cylinder repair kit		37
Clutch slave cylinder Pistons <i>NEW!</i>		54
Clutch weight		55

DRIVE CHAIN

Tourmax XR ring drive chain		56
-----------------------------	--	----

BEARINGS

Steering head bearing set		63
Swing arm Bearing set		63
Wheel bearing & seal kit		63
Crankshaft bearing & seal kit		63
Rear wheel driven flange		89
Needle bearing & bush set		
Shock bearing set <i>NEW!</i>		90

ELECTRIC PARTS

Voltage regulator & rectifier		91
Starter solenoid relay		95
Carbonbrush (starter)***		97
Carbon brush (alternator)***		101
Contact point & condensers		102
Pulser coil		104
Water temp. sending unit		105
Fuel pump point switch		105
Oil pressure switch		105
Neutral switch		105
Radiator fan switch		106

FUEL CONTROL PARTS

Carb. repair kit		107
Float bowl gasket		111
Float needles		114
Air cut-off valve		117
Carb. pump dia. valve set		119
Vacuum valve		120
Carb. Holders		122
Fuel petcock repair kit		124
Fuel petcock assy		130
Carb. Float set		131
Accelerator pump rebuild kit		134

FORK

Fork		135
Front fork oil seal kit		136
Front fork oil seal & dust seal kit		136
Front fork repair kit		136
Front fork oil seal & DU bush set		136

STEERING OIL DAMPER

Steering oil damper	Page	155
Fitting kit		156
Fork tube bracket		157

ENGINE PARTS

Camshaft timing chain		158
Camshaft timing chain for scooter		161
Cam chain tensioner		162
push rod kit		
Primary chains		163
Cylinder head cover reed valve <i>NEW!</i>		164
Starter clutch repair kit		165
Water pump mechanical seal		166
Engine oil seal kit		167
Air filters		169
Valve stem seals		172
Muffler conn gasket		174
Valve shim		176
Camshaft plug set		178
Piston kit		179
Connecting rod kit		180
Mounting rubbers		184
Clutch mastercylinder push rod & bush		185
Carb. rubber passage plug		185
Bronze bush		185
Exhaust pipe gasket		186
Radiators		189
Exhaust seals for MX		190
Silencer conn rubbers		190

OTHERS

Speedo & tachometer cable		191
Rear wheel damper rubbers		196
Step rubbers		197
Grommets		199
Contraol cables		206
Wheel balance weight		211
Chain cutter		214
Nikko horns & locks		215

ATV

Air cut off valve		221
Caliper sealing kit		221
Clutch disc & plate		222
Carb. holder		223
Cam chains		223
Muffler conn gasket		225
Exhaust pipe gasket		226
Fuel petcock repair kit		226
Fork seals		226
Mastercylinder repair kit		227
Pulser coil		227
Regulator		228
Seat mounting cushion		228
steering head bearing		229
Starter solenoid relay		229
Vacuum valve		229
Valve stem seal		230
Water pump mechanical seal		231

VINTAGE BIKE PARTS

232-250

	VOL-39	new information
	VOL-38	new information
	VOL-37	new information
	VOL-36	new information

*** CARBON BRUSH will be discontinued after stock is sold out.

BRAKE PARTS

* Check O.E.Ref. and make sure that you *CPKxxx(quantity requested per model) correct item.

*R&L : In case of double disc models
Front caliper seal kit is for both Right and Left

FRONT

LH upper	RH upper
LH middle	RH middle
LH Lower	RH Lower

REAR

Pos. 1st
Pos. 2nd
Pos. 3rd

forward



MODEL	YEAR	CALIPER SEALING KIT		CALIPER PISTON ONLY		CALIPER PISTON KIT			
		FRONT	REAR	FRONT	REAR	FRONT	REAR		
HONDA									
CR80R	92-02	A1	BCF-132	A1	BCR-116	BCP-126	BCP-115	CPK-136	CPK-137
CR80RB	95-02	A1	BCF-132	A1	BCR-116	BCP-126	BCP-115	CPK-136	CPK-137
CR85R	03-07	A1	BCF-132	A1	BCR-116	BCP-126	BCP-115	CPK-136	CPK-137
CR85RB	03-06	A1	BCF-132	A1	BCR-116	BCP-126	BCP-115	CPK-136	CPK-137
CR125R	87-99	A2	BCF-116	A1	BCR-116	BCP-112	BCP-109	CPK-901(2)	CPK-108(1)
CR125R	00	A2	BCF-116	A1	BCR-116	BCP-116	BCP-109	CPK-907(2)	CPK-108(1)
CR125R	01	A2	BCF-116	A1	BCR-116	BCP-117	BCP-109	CPK-138(2)	CPK-108(1)
CR125R	02-06	A2	BCF-116	A1	BCR-119	BCP-117		CPK-138(2)	
CRF150R	09	A1	BCF-132	A1	BCR-119	BCP-126			
CRF230F	09	A2	BCF-116			BCP-116			
CR250R	92-99	A2	BCF-116	A1	BCR-116	BCP-112	BCP-109	CPK-901(2)	CPK-108(1)
CR250R	00	A2	BCF-116	A1	BCR-116	BCP-116	BCP-109	CPK-907(2)	CPK-108(1)
CR250R	01	A2	BCF-116	A1	BCR-116	BCP-117	BCP-109	CPK-138	CPK-108(1)
CRF250R	02-10	A2	BCF-116	A1	BCR-119	BCP-117		CPK-138	
NX250	88-90		BCF-116						
XL250L	91-96		BCF-116						
XR250R	84-88		BCF-128						
XR250R	89		BCF-116						
XR250R L	90		BCF-116		BCR-116				
XR250R N	92		BCF-116		BCR-116				CPK-108(1)
XR250	93-98		BCF-116		BCR-116	BCP-430	BCP-109	CPK-901	CPK-108(1)
XR250R	99-02		BCF-116		BCR-116	BCP-430	BCP-109	CPK-901	CPK-108(1)
XR250R	04		BCF-116		BCR-116		BCP-109		CPK-108(1)
CM400C CUSTOM	81		BCF-110						
XR400R T/V	96-04		BCF-116		BCR-116	BCP-430		CPK-901	CPK-108(1)
CB450SC	86		BCF-110			BCP-106		CPK-102(2)	
CMX450C	86-87		BCF-110						
CRF450R	02-10	A2	BCF-116	A1	BCR-119	BCP-117		CPK-138	
CR500R	99-00		BCF-116		BCR-116	BCP-430	BCP-109	CPK-901	CPK-108(1)
CR500R	01				BCR-116	BCP-430	BCP-109	CPK-901	CPK-108(1)
CX500/Z	78	R&L	BCF-101			BCP-102		CPK-107(2)	
CX500	79	R&L	BCF-101			BCP-102		CPK-107(2)	
CX500(A)	80	R&L	BCF-101			BCP-102		CPK-107(2)	
CX500(B)	81	R&L	BCF-101			BCP-102		CPK-107(2)	
CX500C(A)	80	R&L	BCF-101			BCP-102		CPK-107(2)	
CX500C(B)	81	R&L	BCF-101			BCP-102		CPK-107(2)	
CX500C(C)	82	R&L	BCF-102			BCP-107		CPK-101(4)	
CX500TC	82	R&L	BCF-102		BCF-110	BCP-107	BCP-107	CPK-101(4)	CPK-101(2)
CX500T TURBO	83	R&L	BCF-105		BCF-110				
FT500 ASCOT	82-83		BCF-110		BCR-102	BCP-107	BCP-114	CPK-101(2)	CPK-110(2)
GB500	89-90		BCF-110			BCP-107		CPK-101(2)	
GL500 SILVERWING	81-82		BCF-110			BCP-107		CPK-101(2)	
GL500I INTERSTATE	81-82	R&L	BCF-102			BCP-107		CPK-101(4)	
GL500D C	82					BCP-107		CPK-101(4)	
NX500N/P/R	92-94		BCF-124		BCR-113				
VF500C MAGNA	84-85		BCF-108			BCP-106		CPK-102(2)	
VF500FE/F2E/FF									
INTERCEPTOR	84-85	R&L	BCF-102		BCF-110	BCP-107	BCP-107	CPK-101(4)	CPK-101(2)
VF500F	86	R&L	BCF-102		BCF-110	BCP-107	BCP-107	CPK-101(4)	CPK-101(2)
VT500C	83-86		BCF-108			BCP-106		CPK-102(2)	
VT500FT ASCOT	83-84		BCF-108			BCP-106		CPK-102(2)	
CB550SC NIGHTHAWK	83		BCF-108			BCP-106		CPK-102(2)	
CBF600N/S	04-05	R&L(A)	BCF-119		BCR-113	BCP-108	BCP-110	CPK-104(4)	CPK-113(1)
CBF600S	06-08	R&L	BCF-119		BCR-113	BCP-108	BCP-110	CPK-104(4)	CPK-113(1)
CBF600N	06-08	R&L	BCF-119		BCR-113	BCP-108	BCP-110	CPK-104(4)	CPK-113(1)
CBF600N/NA/S/SA	06	R&L(A)	BCF-119	A1	BCR-113	BCP-108	BCP-110	CPK-104(4)	CPK-113(1)
CBR600F	87-90	R&L	BCF-120		BCR-102	BCP-115	BCP-114	CPK-137(4)	CPK-110(2)
CBR600F	91-98	R&L	BCF-119		BCR-113	BCP-108	BCP-110	CPK-104(4)	CPK-113(1)
CBR600F	99-00	R&L(B)	BCF-134	A1	BCR-113		BCP-110		CPK-113(1)
CBR600F	01-06	R&L(B4)		A1	BCR-113		BCP-110		CPK-113(1)
CBR600F4	99-01				BCR-113		BCP-110		CPK-113(1)
CBR600FS	95	R&L(A)	BCF-119		BCR-113	BCP-108	BCP-110	CPK-104(4)	CPK-113(1)
CBR600FS	01-02				BCR-113		BCP-110		CPK-113(1)
CBR600FR	94	R&L(A)	BCF-119		BCR-113	BCP-108	BCP-110	CPK-104(4)	CPK-113(1)
CBR600FR	01-02				BCR-113		BCP-110		CPK-113(1)
CBR600RR	07-08				BCR-121				

MODEL	YEAR	CALIPER SEALING KIT		CALIPER PISTON ONLY		CALIPER PISTON KIT		
		FRONT	REAR	FRONT	REAR	FRONT	REAR	
CB600F	98-99	R&L	BCF-120	BCR-113	BCP-109	BCP-110	CPK-108(4)	CPK-113(1)
CB600F	00-06	R&L	BCF-119	BCR-113	BCP-108	BCP-110	CPK-104(4)	CPK-113(1)
CB600F	07-08	R&L	BCF-119	BCR-121	BCP-108		CPK-104(4)	
CB600F2	00-02	R&L	BCF-119	BCR-113	BCP-108	BCP-110	CPK-104(4)	CPK-113(1)
VT600C	88-89		BCF-124					
VT600C	94-04		BCF-116		BCP-109		CPK-108(2)	
VT600CD	88-89		BCF-124					
VT600CD	94				BCP-109		CPK-108(2)	
VT600CD	95-04		BCF-116		BCP-109		CPK-108(2)	
XL600V	87							
XL600R	83-87		BCF-128					
XL600L	93-00		BCF-116					
XR600R	93-97		BCF-116	BCR-116	BCP-430	BCP-109	CPK-901	CPK-108(1)
XR600R	98-99		BCF-116	BCR-116	BCP-430		CPK-901	CPK-108(1)
XR600R	00		BCF-116	BCR-116		BCP-109		CPK-108(1)
CB650	82		BCF-110					
CB650SC	83-85	R&L	BCF-102		BCP-107		CPK-101(4)	
CX650ED	83				BCP-107	BCP-107	CPK-101(4)	CPK-101(2)
CX650C CUSTOM	83		BCF-108		BCP-106		CPK-102(2)	
CX650T TURBO	83		BCF-105		BCP-106		CPK-102(4)	
GL650 SILVERWING	83	R&L	BCF-102		BCP-107		CPK-101(4)	
GL650/I	83	R&L	BCF-102		BCP-107		CPK-101(4)	
NT650 HAWK GT	88-90		BCF-124	BCR-113	BCP-111	BCP-110	CPK-105(2)	CPK-113(1)
NT650 HAWK GT	91		BCF-124	BCR-113				
NT650V W/X/Y	98-00			BCR-113				
NTV650 J	88		BCF-124	BCR-113	BCP-111		CPK-105(2)	
NTV650 K/L	89-90		BCF-124	BCR-113				
NTV650 M/N	91-92							
NX650(J)	88		BCF-124	BCR-113				
NX650	89-94		BCF-124	BCR-113				
XL650V TRANSALP	01-03	R&L	BCF-120	BCR-113				CPK-113
XR650J	88		BCF-124	BCR-113				
XR650L	01-04		BCF-116	BCR-116		BCP-109		CPK-108(1)
XR650R	00			BCR-116		BCP-109		CPK-108(1)
XR650R	01-05	A2	BCF-116	BCR-116	BCP-116	BCP-109	CPK-907(2)	CPK-108(1)
CB700SC NIGHTHAWK	84-86	R&L	BCF-105					
VF700C MAGNA	84-86	R&L	BCF-102					
VF700C MAGNA	87		BCF-110					
VF700F								
INTERCEPTOR	84-85	R&L	BCF-105	BCR-102	BCP-106		CPK-102(4)	
VF700S SABRE	84-85	R&L	BCF-102					
VFR700F/F2								
INTERCEPTOR	86-87	R&L	BCF-107R	BCR-102				
VT700C SHADOW	86-87		BCF-108		BCP-106		CPK-102(2)	
CB750F								
SUPERSPORT	77-80	R&L	BCF-101					
CB750F Z	79	R&L	BCF-101	BCR-101				
CB750F A	80	R&L	BCF-101	BCR-101	BCP-102		CPK-107(2)	
CB750F B	81	R&L	BCF-101	BCR-101	BCP-102		CPK-107(2)	
CB750F C/2C	82	R&L	BCF-102	BCR-102	BCP-107	BCP-114	CPK-101(4)	CPK-110(2)
CB750F2	92							
CB750F2	94-95							
CB750F2	96							
CB750F2	97-99	R&L	BCF-119	BCR-113	BCP-108	BCP-110	CPK-104(4)	CPK-113(1)
CB750F2	00-01	R&L	BCF-119	BCR-113	BCP-108	BCP-110	CPK-104(4)	CPK-113(1)
CB750 NIGHTHAWK	91-92		BCF-116	BCR-113	BCP-109		CPK-108(2)	
CB750 NIGHTHAWK	93-94		BCF-116		BCP-109		CPK-108(2)	
CB750 NIGHTHAWK	95-96		BCF-116	BCR-113	BCP-109		CPK-108(2)	
CB750SC	82-83	R&L	BCF-102		BCP-107		CPK-101(4)	
VF750C C/D	82-83	R&L	BCF-102		BCP-107		CPK-101(4)	
VF750C E	84				BCP-107		CPK-101(4)	
VF750C J	88		BCF-124		BCP-107		CPK-101(2)	
VF750CD	95-96		BCF-128		BCP-108		CPK-104(2)	
VF750F D/E	83-84	R&L	BCF-105	BCR-102	BCP-106	BCP-114	CPK-102(4)	CPK-110(2)
VF750F F	85							
VF750S C/D	82-83	R&L	BCF-102		BCP-107		CPK-101(4)	
VFR750C MAGNA	94-96				BCP-108		CPK-104(2)	
VFR750CD MAGNA	95-96				BCP-108		CPK-104(2)	
VFR750F G	86	R&L	BCF-107R	BCR-102	BCP-111	BCP-114	CPK-105(4)	CPK-110(2)
VFR750F H	87	R&L	BCF-107R	BCR-102				
VFR750F2	86-87					BCP-114		CPK-110(2)
VFR750F J/K	88-89	R&L	BCF-119	BCF-116				
VFR750F	90-95	R&L	BCF-119	BCF-116	BCP-108	BCP-109	CPK-104(4)	CPK-108(2)
VFR750F T	96	R&L	BCF-119	BCF-116				
VFR750R J	88					BCP-108		CPK-104(2)
VT750C	97-01		BCF-116		BCP-109		CPK-108(2)	
VT750C	05-09		BCF-117		BCP-108		CPK-104(2)	
VT750C2 V-1	97-01		BCF-116		BCP-109		CPK-108(2)	
VT750C3	01		BCF-116		BCP-109		CPK-108(2)	
VT750DC	01-02		BCF-116					
XLV750RF	85		BCF-108					
XR750L/M/N	90-92	R&L	BCF-120	BCR-113				
XR750P-Y	93-00	R&L	BCF-120	BCR-113				
NV750C2	99		BCF-116		BCP-109		CPK-108(2)	
PC800	89	R&L	BCF-120		BCP-115		CPK-137(4)	
PC800	90-95	R&L	BCF-120		BCP-109		CPK-108(4)	
PC800	96	R&L	BCF-120					

MODEL	YEAR	CALIPER SEALING KIT			CALIPER PISTON ONLY			CALIPER PISTON KIT			
		FRONT		REAR	FRONT		REAR	FRONT		REAR	
PC800	97-98										
VFR800F1	98-00	R&L	BCF-121	A3	BCR-114	BCP-119	BCP-123	BCP-118	CPK-120(1)	CPK-125(1)	CPK-118(1)
						BCP-120	BCP-120	BCP-116	CPK-121(1)	CPK-121(1)	CPK-907(1)
						BCP-118	BCP-119	BCP-118	CPK-118(1)	CPK-120(1)	CPK-118(1)
VFR800F1	01	R&L(A	BCF-121	A3	BCR-114	BCP-119	BCP-123	BCP-118	CPK-120(1)	CPK-125(1)	CPK-118(1)
						BCP-120	BCP-120	BCP-116	CPK-121(1)	CPK-121(1)	CPK-907(1)
						BCP-118	BCP-119	BCP-118	CPK-118(1)	CPK-120(1)	CPK-118(1)
VFR800	02-05	R&L(A	BCF-130	A3	BCR-118	BCP-119	BCP-119	BCP-119	CPK-120(1)	CPK-120(1)	CPK-120(1)
						BCP-121	BCP-120	BCP-121	CPK-124(1)	CPK-121(1)	CPK-124(1)
						BCP-119	BCP-119	BCP-119	CPK-120(1)	CPK-120(1)	CPK-120(1)
VFR800A	02-3	R&L	BCF-130		BCR-118	BCP-119	BCP-119	BCP-119	CPK-120(1)	CPK-120(1)	CPK-120(1)
						BCP-121	BCP-120	BCP-121	CPK-124(1)	CPK-121(1)	CPK-124(1)
						BCP-119	BCP-119	BCP-119	CPK-120(1)	CPK-120(1)	CPK-120(1)
						BCP-121	BCP-119	BCP-119	CPK-124(1)	CPK-121(1)	CPK-124(1)
VT800C	88		BCF-110			BCP-107			CPK-101(2)		
CB900C	80	R&L	BCF-101		BCF-106	BCP-102			CPK-107(2)		
CB900C	81	R&L	BCF-104		BCF-106						
CB900C	82	R&L	BCF-102		BCF-110						
CB900F Z/A	79-80	R&L	BCF-101		BCR-101	BCP-107		BCP-107	CPK-101(4)		CPK-101(2)
CB900F B/2B	81	R&L	BCF-102		BCR-102	BCP-102		BCP-102	CPK-107(2)		CPK-107(1)
CB900F C/2C	82	R&L	BCF-102		BCR-102	BCP-107		BCP-114	CPK-101(4)		CPK-110(2)
CB900F D/F2D	83				BCR-102						
CB900F	02-05			A1	BCR-113			BCP-110			CPK-113(1)
CB900F	06-07			A1	BCR-113						
CBR900RR N	92	R&L(B	BCF-115R	A1	BCR-113	BCP-124		BCP-110	U. CPK-134(4)		CPK-113(1)
						BCP-125			L. CPK-135(4)		
CBR900RR P	93	R&L(B	BCF-133	A1	BCR-113	BCP-124		BCP-110	U. CPK-114(4)		CPK-113(1)
						BCP-125			L. CPK-115(4)		
CBR900RR R	94-97	R&L(B	BCF-133	A1	BCR-113			BCP-110	U. CPK-114(4)		CPK-113(1)
									L. CPK-115(4)		
CBR900RR	98-99	R&L	BCF-126	A1	BCR-113			BCP-110			CPK-113(1)
CBR900RR	00-03			A1	BCR-113						
CBR900RE	01			A1	BCR-113						
CB1000C(I/A)	83	R&L	BCF-102		BCF-110						
CBR1000F H/J	87-88	R&L	BCF-107R		BCR-102	BCP-111		BCP-114	CPK-105(4)		CPK-110(2)
CBR1000F K	89										
CBR1000F (USA)	90-91	R&L	BCF-120		BCF-116	BCP-109		BCP-115	CPK-108(4)		CPK-106(2)
CBR1000F (EURO)	90-91	R&L	BCF-119			BCP-108			CPK-104(4)		
CBR1000F R	94	R&L	BCF-127								
CBR1000F S	95	R&L	BCF-127								
CBR1000F V	97	R&L	BCF-127								
CBR1000RR	06-07				BCR-121						
CBX Z	79	R&L	BCF-104		BCR-101			BCP-102			CPK-107(1)
CBX A	80	R&L	BCF-104		BCR-101						
CBX B/C	81-82	R&L	BCF-102		BCR-102	BCP-107		BCP-114	CPK-101(4)		CPK-110(2)
GL1000 GOLDWING		R&L	BCF-101		BCR-104						
GL1000 K1/K2		R&L	BCF-101		BCR-104						
GL1000 LTD		R&L	BCF-101		BCR-104						
GL1000K3/Z		R&L	BCF-101		BCR-103	BCP-102			CPK-107(2)		
VF1000F(2F/2G)BOL'D	85-86	R&L	BCF-105		BCF-108			BCP-106	CPK-102(4)		CPK-102(2)
OR						BCP-106					
VF1000F E/F/G	84-86	R&L	BCF-105		BCF-108	BCP-106		BCP-106	CPK-102(4)		CPK-102(2)
VF1000R F/G	85-86					BCP-106			CPK-102(4)		
VTR1000F	97-01	R&L(B	BCF-125		BCR-113	BCP-124		BCP-110	U. CPK-114(4)		CPK-113(1)
						BCP-125			L. CPK-115(4)		
VTR1000F	02	R&L	BCF-125		BCR-113						
VTR1000SP	00-01				BCR-113						
VTR1000SP	02-04			A1	BCR-113			BCP-110			CPK-113(1)
XL1000 X/Y/1	99-00	R&L	BCF-123		BCR-114						
XL1000V	01-05	R&L(A	BCF-123		BCR-114	BCP-119	BCP-123	BCP-118	CPK-120(1)	CPK-125(1)	CPK-118(1)
						BCP-120	BCP-120	BCP-116	CPK-121(1)	CPK-121(1)	CPK-907(1)
						BCP-119	BCP-123	BCP-118	CPK-120(1)	CPK-125(1)	CPK-118(1)
CB1100F SUPERSPORT	83	R&L	BCF-102		BCR-102	BCP-107		BCP-114	CPK-101(4)		CPK-110(2)
CB1100R B	81				BCR-102						
CB1100R C	82				BCR-102						
CB1100SF Y	00	R&L	BCF-121		BCR-114						
CBR1100XX	97-04	R&L	BCF-121		BCR-115	BCP-119	BCP-123	BCP-118	CPK-120(1)	CPK-125(1)	CPK-118
						BCP-120	BCP-120	BCP-121	CPK-121(1)	CPK-121(1)	CPK-124
						BCP-118	BCP-119	BCP-118	CPK-118(1)	CPK-120(1)	CPK-118
GL1100A/1A/DA/B/1B/DB	80-81	R&L	BCF-104		BCF-106						
GL1100C/1C/DC/AC	82	R&L	BCF-102		BCF-110	BCP-107		BCP-107	CPK-101(4)		CPK-101(2)
GL1100D/1D/DD/D2D/AD	83	R&L	BCF-111						CPK-102(4)		
ST1100	90-96	R&L	BCF-120		BCF-116	BCP-106			CPK-108(4)		
ST1100 V/W	97-98	R&L	BCF-120			BCP-109			CPK-108(4)		
ST1100	99-01	R&L	BCF-120		BCR-102	BCP-109			CPK-108(4)		
ST1100	02	R&L	BCF-120		BCR-102						
ST1100A	92-95	R&L	BCF-120		BCF-116	BCP-109			CPK-108(4)		
ST1100A	96-001	R&L	BCF-127		BCR-114						
ST1100A	02	R&L	BCF-127		BCR-114						
VF1100C	83-86	R&L	BCF-105		BCF-110	BCP-106		BCP-107	CPK-102(4)		CPK-101(2)
VF1100S	84-85	R&L	BCF-105		BCF-110	BCP-106		BCP-107	CPK-102(4)		CPK-101(2)
VT1100C	85-86	R&L	BCF-102			BCP-107			CPK-101(4)		
VT1100C	87-93		BCF-110			BCP-107			CPK-101(2)		

MODEL	YEAR	CALIPER SEALING KIT			CALIPER PISTON ONLY			CALIPER PISTON KIT			
		FRONT	REAR		FRONT	REAR		FRONT	REAR		
VT1100C	94		BCF-116			BCP-109			CPK-108(2)		
VT1100C	95-96		BCF-116			BCP-109			CPK-108(2)		
VT1100C	98-04		BCF-116			BCP-109			CPK-108(2)		
VT1100C2	95-96		BCF-116			BCP-109			CPK-108(2)		
VT1100C2	97-98		BCF-116			BCP-109			CPK-108(2)		
VT1100C2	99-00		BCF-116			BCP-109			CPK-108(2)		
VT1100C2	01-02		BCF-116		BCR-113						
VT1100C2	02-04		BCF-116		BCP-109				CPK-108(2)		
VT1100C3	98-00		BCF-116		BCP-109		BCP-110		CPK-108(2)	CPK-113(1)	
GL1200	84	R&L	BCF-111								
GL1200(E)	84	R&L	BCF-111								
GL1200A(E)	84	R&L	BCF-111								
GL1200A USA	85-87	R&L	BCF-111								
GL1200D(E) <MKT C,M,E,EL>	84	R&L	BCF-111								
GL1200D(E) MKT G	84	R&L	BCF-111								
GL1200I USA	85-87	R&L	BCF-111								
GL1200L	85	R&L	BCF-111								
GL1200SEI	86	R&L	BCF-111								
ST1300	02-04	R&L(A)	BCF-131	A3	BCR-115	BCP-118	BCP-123	BCP-122	CPK-118(1)	CPK-125(1)	CPK-132
						BCP-120	BCP-120	-	CPK-121(1)	CPK-121(1)	-
						BCP-118	BCP-123	BCP-122	CPK-118(1)	CPK-125(1)	CPK-132
VTX1300S	03-04		BCF-116								
VTX1300S	05	A2	BCF-128	A1	BCR-113	BCP-108		BCP-110	CPK-104(2)		CPK-113
VTX1300C	04		BCF-128								
GL1500 GOLDWING	88-90	R&L	BCF-118								
GL1500A	91-92	R&L	BCF-118								
GL1500A	93-94	R&L	BCF-118			BCF-108		BCP-106	CPK-104(2)	-	CPK-102(2)
GL1500A	95	R&L	BCF-118			BCF-108	BCP-108	BCP-106	CPK-104(2)	-	CPK-102(2)
GL1500A	96-00	R&L	BCF-118			BCF-108		BCP-106			CPK-102(2)
GL1500C	01-03										
GL1500I	91-96	R&L	BCF-118					BCP-106			CPK-102(2)
GL1500SE	90-92	R&L	BCF-118					BCP-106			CPK-102(2)
GL1500SE	93-94	R&L	BCF-118			BCF-108	BCP-108	BCP-106	CPK-104(2)	-	CPK-102(2)
GL1500SE	95	R&L	BCF-118			BCF-108	BCP-108	BCP-106	CPK-104(2)	-	CPK-102(2)
GL1500SE	96-00	R&L	BCF-118			BCF-108		BCP-106			CPK-102(2)
GL1500CF	99-00										
GL1800A	01-04	R&L(A)	BCF-121	A3	BCR-114	BCP-118	BCP-119	BCP-122	CPK-118(1)	CPK-120(1)	CPK-133
						BCP-116	BCP-121	-	CPK-907(1)	CPK-124(1)	-
						BCP-118	BCP-118	BCP-122	CPK-118(1)	CPK-118(1)	CPK-133
VTX1800C	02-04	R&L	BCF-127								
KAWASAKI											
KX80E	84-93		ACK-451								
KX80R	94-95		ACK-451					BCP-430			CPK-901
KX80R	96		ACK-451								
KX80R	97		BCR-405								
KX80T	91-94		ACK-451								
KX80W	98-00	A2	BCR-405	A1	BCR-120	BCP-435		BCP-430	CPK-424(2)		CPK-901
KX85	01-08	A2	BCR-405	A1	BCR-120	BCP-435		BCP-430	CPK-424(2)		CPK-901
KX125	84-85		ACK-453								
KX125	86		ACK-453		ACK-451						
KX125	87-88				ACK-451						
KX125	89-91		BCF-116		ACS-355				CPK-903(2)		CPK-906
KX125	92-93		BCF-116		ACS-355				CPK-901(2)		CPK-905
KX125	94-96		BCF-116		BCR-116				CPK-901(2)		CPK-108
KX125	97				BCR-116						CPK-108
KX125	98				BCR-116			BCP-109			CPK-108(1)
KX125	99-00				BCR-116			BCP-109			CPK-108(1)
KX125	01-05		BCF-116		BCR-116			BCP-109			CPK-108(1)
KDX200 E1-E4	89-92				BCR-116						
KDX200 E5-E6	93-94		BCF-116		BCR-116	BCP-432			CPK-903		
KDX200 H1-H5	95-99		BCF-116		ACK-457	BCP-430		BCP-433	CPK-901		CPK-905
KDX220 A4-A7	97-00		BCF-116			BCP-430			CPK-901		
Z250A1-A3											
Z250 P1-P4	83-86										
EL250B2/B3	88-89		BCF-408			BCP-411			CPK-407(1)		
EL250D4/D5	93-94		BCF-408								
EL250E1-E4	91-93		BCF-408			BCP-411			CPK-407(1)		
EL250E4	94		BCF-408								
EX250E1/E2	86-87		BCF-408		BCF-408	BCP-411		BCP-411	CPK-407(1)		CPK-407(1)
EX250F2-F11 NINJA	88-97		BCF-405		BCR-405	BCP-416B		BCP-410	CPK-408U(1)		CPK-413(2)
						BCP-416A			CPK-408L(1)		
EX250F12-F14 NINJA	98-00		BCF-405		BCR-405	BCP-416B		BCP-410	CPK-408U(1)		CPK-413(2)
						BCP-416A			CPK-408L(1)		
EX250H1-H14	90-03	A2	BCF-405	A1		BCP-416B			CPK-408U(1)		
						BCP-416A			CPK-408L(1)		
KDX250	92-94										
KLX250R D2-D4	94-96		BCF-116		ACK-457	BCP-430		BCP-433	CPK-901		CPK-905
KR250(KR1)	89										
KX250	86-88				ACK-451						
KX250	89-91		BCF-116		ACS-355				CPK-903(2)		CPK-906
KX250	92-93		BCF-116		ACS-355				CPK-901(2)		CPK-905
KX250	94-96		BCF-116		BCR-116				CPK-901(2)		CPK-108

MODEL	YEAR	CALIPER SEALING KIT			CALIPER PISTON ONLY			CALIPER PISTON KIT		
		FRONT		REAR	FRONT		REAR	FRONT		REAR
KX250	97-00			BCR-116			BGP-109			CPK-108
KX250	01-05	BCF-116		BCR-116			BGP-109			CPK-108
KX250R6F	06	BCF-116		BCR-116						CPK-108
KX250F	04-10	BCF-116		BCR-410						
KLX300R	98-00	BCF-116		BCR-116	BGP-430		BGP-109	CPK-901		CPK-108
KLX300R	01-03	BCF-116		BCR-116	BGP-430			CPK-901		
EX305B1	83	BCF-408								
KZ305A1/A2 CSR	81-82	BCF-401			BGP-404			CPK-401(1)		
KZ305B1 CSR BELT	83	BCF-401			BGP-404			CPK-401(1)		
KZ305 B2/B3 LTD BELT	87-88	BCF-401			BGP-404			CPK-401(1)		
KZ440A1-A3 LTD	80-82	BCF-402			BGP-406			CPK-403(1)		
KZ440A4 LTD	83	BCF-401								
KZ440D1-D4 LTD BELT	80-82	BCF-402			BGP-406			CPK-403(1)		
KZ440D5 LTD BELT	83	BCF-401			BGP-406			CPK-403(1)		
KZ440D6	84									
KZ440G1	82	BCF-401			BGP-404			CPK-401(1)		
EN450A1-A6 LTD 454	85-90	BCF-408			BGP-411			CPK-407(1)		
KX450F	06-10	BCF-116		BCR-410						
EN500A1-A7 VULCAN	90-96	BCF-408			BGP-411			CPK-407(1)		
EN500A8	97				BGP-411			CPK-407(1)		
EN500C	96-08	A1 BCF-408			BGP-411			CPK-407(1)		
ER500A1-A3 ER-5	97-99	BCF-405								
EX500A1-A7	87-93	BCF-405			BGP-416B			CPK-408U(1)		
					BGP-416A			CPK-408L(1)		
EX500D	94-08	A2 BCF-405	A1	ACK-453	BGP-416B			CPK-408U(1)		
					BGP-416A			CPK-408L(1)		
KX500	84-85	ACK-453								
KX500	86	ACK-453		ACK-451						
KX500	87-88			ACK-451						
KX500	89-93	BCF-116		ACS-355						
KX500	94-02	BCF-116		BCR-116	BGP-430		BGP-109	CPK-901(2)		CPK-108
KZ550A1	80	BCF-402			BGP-406			CPK-403(1)		
KZ550A2/A3/A4	81-83	BCF-401			BGP-404			CPK-401(1)		
KZ550C1/C2	80-81									
KZ550C3/C4	82-83	BCF-401			BGP-404			CPK-401(1)		
KZ550D1	81	R&L BCF-403		BCR-401	BGP-404		BGP-404	CPK-401(2)		CPK-401(1)
KZ550F1 SPECTRE	83	BCF-401			BGP-404			CPK-401(1)		
KZ550F2 LTD	84	BCF-401			BGP-404			CPK-401(1)		
KZ550H1/H2	82-83	R&L BCF-403		BCR-401	BGP-404		BGP-404	CPK-401(2)		CPK-401(1)
KZ550M1 LTD	83	BCF-401			BGP-404			CPK-401(1)		
Z550C1/C2	80-81	R&L BCF-403								
Z550G1-G9 GT550	83-91									
ZR550B1	90	R&L BCF-407			BGP-416B		BGP-410	CPK-408U(2)		CPK-413(2)
					BGP-416A			CPK-408L(2)		
ZR550B2/B3	91-92	R&L BCF-407			BGP-416B		BGP-410	CPK-408U(2)		CPK-413(2)
					BGP-416A			CPK-408L(2)		
ZR550B4	93	R&L BCF-407								
ZR550B5	94			BCR-406	BGP-416B			CPK-408U(2)		
					BGP-416A			CPK-408L(2)		
ZX550A1-A3	84-86	R&L BCF-406		BCF-408	BGP-411		BGP-411	CPK-407(2)		CPK-407(1)
ZL600A1/A2	86-87	BCF-408			BGP-411			CPK-407(1)		
ZL600B2/B3	96-97	BCF-405			BGP-416B			CPK-408U(1)		
					BGP-416A			CPK-408L(1)		
ZX600A1/A2/A3										
GPZ600R	85-87	R&L BCF-406		BCF-408	BGP-411		BGP-411	CPK-407(2)		CPK-407(1)
ZX600B1	87	R&L BCF-406		BCF-408	BGP-411		BGP-411	CPK-407(2)		CPK-407(1)
ZX600C1-C9	88-96	R&L BCF-407		BCF-405	BGP-416B		BGP-416B	CPK-408U(2)		CPK-408U(1)
					BGP-416A		BGP-416A	CPK-408L(2)		CPK-408L(1)
ZX600C10	97	R&L(B BCF-407		BCF-405						
ZX600D1-D3	90-92	R&L(B BCF-417		BCF-405	BGP-414		BGP-416B	CPK-409(8)		CPK-408U(1)
							BGP-416A	CPK-408L(1)		CPK-408L(1)
ZX600D4	93	R&L(B BCF-417		BCF-405	BGP-414		BGP-416B	CPK-409(8)		CPK-408U(1)
							BGP-416A	CPK-408L(1)		CPK-408L(1)
ZX600E1-E8	93-00	R&L(B BCF-417	A1	BCR-406	BGP-417			CPK-410(8)		
ZX600E9	01	R&L(B BCF-417	A1	BCR-406	BGP-417			CPK-410(8)		
ZX600E10-E11	02-03	R&L(B BCF-417	A1	BCR-406	BGP-417			CPK-410(8)		
ZX600E12-E13	04-05	R&L(B BCF-421	A1	BCR-406						
ZX600E6F	06	R&L(B BCF-421	A1	BCR-406						
ZX600F1-F2	95-96	R&L BCF-417			BGP-417			CPK-410(8)		
ZX600F3	97	R&L BCF-417		BCR-406	BGP-417			CPK-410(8)		
ZX600G1/G2	98-99	R&L BCF-415		BCR-406				CPK-417(12)		CPK-421(1)
ZX600J	00-08	R&L(B BCF-416		BCR-406	BGP-419	U		U. CPK-417(4)		CPK-421(1)
					BGP-419	M		M. CPK-417(4)		
					BGP-420	L		L. CPK-418(4)		
ZX600N1/N6F	05-06			BCR-406			BGP-423			CPK-421(1)
ZX600P	07-08			BCR-406						
ZX636A1	02									
ZX636B	03-04			BCR-406			BGP-423			CPK-421(1)
ZX636C	05-06	R&L BCF-424								
ZX636M1	04	R&L BCF-424								
ZX636N1	05	R&L BCF-424								
ZX636N6F	06	R&L BCF-424								
EJ650A1/A2	99-00	BCF-413								
EX650A	08	BCF-422	A2	BCR-406	BGP-425		BGP-423	CPK-423(4)		CPK-421(1)

MODEL	YEAR	CALIPER SEALING KIT		CALIPER PISTON ONLY		CALIPER PISTON KIT			
		FRONT	REAR	FRONT	REAR	FRONT	REAR		
KL650A	87-00		BCF-411			BGP-401		CPK-412(1)	
KL650B2-B3 TENGAI	90-91		BCF-405			BGP-416B BGP-416A		CPK-408U(1) CPK-408L(1)	
KLR650E	08		BCF-116			BGP-431		CPK-108(2)	
KLE650	08	R&L	BCF-422	BCR-406		BGP-425	BGP-423	CPK-423(4)	CPK-421(1)
KZ650B	77-79		BCF-402			BGP-407		CPK-404(1)	
Z650C1-C2	77-78					BGP-408		CPK-402(2)	
Z650C3	79					BGP-406		CPK-403(2)	
KZ650C4	80	R&L	BCF-404	BCR-402					
Z650D1	78					BGP-408	BGP-409	CPK-402(2)	CPK-406(2)
Z650D2	79			BCR-402		BGP-406	BGP-405	CPK-403(2)	CPK-405(2)
KZ650D3	80	R&L	BCF-404	BCR-402					
KZ650E1 LTD	80		BCF-402			BGP-406		CPK-403(1)	
KZ650F1	80		BCF-402			BGP-406		CPK-403(1)	
Z650F2/F3	81-82	R&L	BCF-403						
KZ650H1-H3	81-83		BCF-401			BGP-404		CPK-401(1)	
KZ700A1	84	R&L	BCF-403	BCR-401		BGP-404	BGP-404	CPK-401(2)	CPK-401(1)
VN700A1	85	R&L	BCF-406			BGP-411	BGP-411	CPK-407(2)	CPK-407(1)
ZN700A1/A2 LTD	84-85	R&L	BCF-406	BCF-405		BGP-411		CPK-407(2)	
KZ750B1	76		BCF-402	BCR-403					
KZ750B2	77		BCF-402	BCR-403		BGP-407	BGP-407	CPK-404(1)	CPK-404(1)
KZ750B3-B4 2 CYL	78-79		BCF-402	BCR-403		BGP-407	BGP-407	CPK-404(1)	CPK-404(1)
KZ750E1-E3	80-82	R&L	BCF-403	BCR-401		BGP-404	BGP-404	CPK-401(2)	CPK-401(1)
KZ750F1	83	R&L	BCF-403	BCR-401		BGP-404	BGP-404	CPK-401(2)	CPK-401(1)
KZ750G1 LTD 2CYL	80		BCF-402			BGP-406		CPK-403(1)	
KZ750H1 LTD	80	R&L	BCF-403	BCR-401		BGP-404	BGP-404	CPK-401(2)	CPK-401(1)
KZ750H2-H4	81-83	R&L	BCF-403	BCR-401		BGP-404	BGP-404	CPK-401(2)	CPK-401(1)
KZ750K1/K2 LTD	83-84		BCF-408						
KZ750L3	83	R&L	BCF-403	BCR-401		BGP-404	BGP-404	CPK-401(2)	CPK-401(1)
KZ750M1 CSR 2 CYL	82		BCF-401			BGP-404		CPK-401(1)	
KZ750N1/N2									
SPECTRE	82-83	R&L	BCF-403	BCR-401		BGP-404	BGP-404	CPK-401(2)	CPK-401(1)
KZ750R1	82	R&L	BCF-403	BCR-401		BGP-404	BGP-404	CPK-401(2)	CPK-401(1)
VN750A1	85					BGP-411		CPK-407(2)	
VN750A	86-98	R&L	BCF-406			BGP-411		CPK-407(2)	
ZR750C1-C24	91-94	R&L(A)	BCF-407	BCF-405		BGP-416B BGP-416A	BGP-416B BGP-416A	CPK-408U(2) CPK-408L(2)	CPK-408U(1) CPK-408L(1)
ZR750C3 CANADIAN MODEL	93	R&L	BCF-407	BCF-405					
ZX750A1-A2 GPz	83-84	R&L	BCF-406	BCF-408		BGP-411	BGP-411	CPK-407(2)	CPK-407(1)
ZX750A3 GPz	85	R&L	BCF-406	BCF-408		BGP-411	BGP-411	CPK-407(2)	CPK-407(1)
ZX750E1/E2 TURBO	84-85	R&L	BCF-406	BCF-408		BGP-411	BGP-411	CPK-407(2)	CPK-407(1)
ZX750F1-F4 GPX750R	87-90	R&L	BCF-407	BCF-405		BGP-416B BGP-416A	BGP-416B BGP-416A	CPK-408U(2) CPK-408L(2)	CPK-408U(1) CPK-408L(1)
ZX750G2 GPZ750R	85	R&L	BCF-406	BCF-408					
ZX750H1/H2	90-91	R&L	BCF-418			BGP-415A BGP-415B		CPK-414U(4) CPK-414L(4)	
ZX750J1-J2 ZXR	91-92	R&L	BCF-418			BGP-415A BGP-415B		CPK-414U(4) CPK-414L(4)	
ZX750K1/K2 ZX7R	91-92	R&L	BCF-418			BGP-415A BGP-415B		CPK-414U(4) CPK-414L(4)	
ZX750L1-L3 ZXR750	93-95	R&L	BCF-417	BCR-409		BGP-417	BGP-413	CPK-410(8)	CPK-416(2)
ZX750M1/M2	93-94	R&L	BCF-418	BCR-409		BGP-415A BGP-415B	BGP-413	CPK-414U(4) CPK-414L(4)	CPK-416(2)
ZX750P1-P3	96-98	R&L	BCF-416	BCR-409			BGP-424	U. CPK-417(4) M. CPK-417(4) L. CPK-418(4)	CPK-422(2)
ZX750P4-P5	99-00	R&L	BCF-416	BCR-409			BGP-424	U. CPK-417(4) M. CPK-417(4) L. CPK-418(4)	CPK-422(2)
VN800A	95-98		BCF-408			BGP-411		CPK-407(1)	
VN800B1/B2	96-97		BCF-413			BGP-425		CPK-423(2)	CPK-423(2)
VN800B3-B5	98-06		BCF-413			BGP-425		CPK-423(2)	
VN800C1-C2	99-00		BCF-413						
VN800E1/E2	01-02		BCF-413	BCF-420					
KZ900A4/A5	76-77		BCF-402						
KZ900B1 LTD	76	R&L	BCF-404	BCR-403					
VN900B	08			BCR-412					
Z1 Z1A/B 900	73-75								
ZL900A1/A2	85-86	R&L	BCF-406	BCF-408		BGP-411	BGP-411	CPK-407(2)	CPK-407(1)
ZX900A1/A2 GPZ900R	84-85	R&L	BCF-406	BCF-408		BGP-411		CPK-407(2)	
ZX900A3 NINJA	86-89	R&L	BCF-406	BCF-408		BGP-411		CPK-407(2)	
ZX900A4-A6 NINJA	86-89	R&L	BCF-406	BCF-408					
ZX900A7-A8	90-91	R&L	BCF-417	BCF-405					
ZX900B1-B2	94-95	R&L	BCF-417	BCR-406		BGP-417		CPK-410(8)	
ZX900B3-B4	96-97	R&L	BCF-416	BCR-406				U. CPK-417(4) M. CPK-417(4) L. CPK-418(4)	
ZX900C1-C2	98-99	R&L	BCF-416	BCR-406				U. CPK-417(4) M. CPK-417(4) L. CPK-418(4)	CPK-421(1)
ZX900E1-E2	00-01	R&L	BCF-416	BCR-406				U. CPK-417(4) M. CPK-417(4) L. CPK-418(4)	CPK-421(1)
KZ1000A1	77	R&L	BCF-404	BCR-402		BGP-407	BGP-409	CPK-404(2)	CPK-406(2)

MODEL	YEAR	CALIPER SEALING KIT		CALIPER PISTON ONLY		CALIPER PISTON KIT		
		FRONT	REAR	FRONT	REAR	FRONT	REAR	
KZ1000A2	78	R&L	BCF-404	BCR-402	BCP-408	BCP-409	CPK-402(2)	CPK-406(2)
KZ1000A3/A4	79-80	R&L	BCF-404	BCR-402	BCP-406	BCP-405	CPK-403(2)	CPK-405(2)
KZ1000B1	77	R&L	BCF-404		BCP-408		CPK-402(2)	
KZ1000B2 LTD	78	R&L	BCF-404		BCP-408		CPK-402(2)	
KZ1000B3-B4 LTD	79-80	R&L	BCF-404	BCR-402	BCP-406	BCP-405	CPK-403(2)	CPK-405(2)
KZ1000C1	78			BCR-402		BCP-405		CPK-405(2)
KZ1000C1A POLICE	78			BCR-402				
KZ1000C2/C3/C4	79-81	R&L	BCF-404	BCR-402	BCP-406	BCP-405	CPK-403(2)	CPK-405(2)
KZ1000D1 Z1R	78			BCR-402	BCP-408	BCP-409	CPK-402(2)	CPK-406(2)
KZ1000D3 Z1R	80	R&L	BCF-404	BCR-402	BCP-406	BCP-405	CPK-403(2)	CPK-405(2)
KZ1000E1/E2	79-80	R&L	BCF-404	BCR-402	BCP-406	BCP-405	CPK-403(2)	CPK-405(2)
KZ1000G1	80	R&L	BCF-404	BCR-402	BCP-406	BCP-405	CPK-403(2)	CPK-405(2)
KZ1000J1/J2	81-82	R&L	BCF-403	BCR-401	BCP-404	BCP-404	CPK-401(2)	CPK-401(1)
KZ1000J3	83	R&L	BCF-403	BCR-401	BCP-404	BCP-404	CPK-401(2)	CPK-401(1)
KZ1000K1/K2 LTD	81-82	R&L	BCF-403	BCR-401	BCP-404	BCP-404	CPK-401(2)	CPK-401(1)
KZ1000M1/M2	81-82	R&L	BCF-403	BCR-401	BCP-404	BCP-404	CPK-401(2)	CPK-401(1)
KZ1000P1-P15 POLICE	82-96	R&L	BCF-403	BCR-401	BCP-404	BCP-404	CPK-401(2)	CPK-401(1)
KZ1000P16 POLICE	97	R&L	BCF-403	BCR-401	BCP-404	BCP-404	CPK-401(2)	CPK-401(1)
KZ1000R	82-83	R&L	BCF-403	BCR-401	BCP-404	BCP-404	CPK-401(2)	CPK-401(1)
ZG1000A1-A8	86-93	R&L	BCF-406	BCF-408	BCP-411	BCP-411	CPK-407(2)	CPK-407(1)
ZG1000A9-A12	94-97	R&L	BCF-407	BCF-408	BCP-416B	BCP-411	CPK-408U(2)	CPK-407(1)
ZG1000A13-A14	98-99	R&L	BCF-407	BCF-408	BCP-416B BCP-416A		CPK-408L(2) CPK-408L(2)	
ZL1000A1 ELIMINATOR	87	R&L	BCF-406	BCF-408	BCP-411	BCP-411	CPK-407(2)	CPK-407(1)
ZR1000A1-A3	03-05			BCF-408	BCP-411			
ZX1000A1/A2	85-86	R&L	BCF-406	BCF-408	BCP-411	BCP-411	CPK-407(2)	CPK-407(1)
ZX1000A3	87							
ZX1000B1-B3	88-90	R&L	BCF-407	BCF-405	BCP-416B BCP-416A	BCP-416B BCP-416A	CPK-408U(2) CPK-408L(2)	CPK-408U(1) CPK-408L(1)
ZX1000C1-C2	04-05	R&L	BCF-424					
ZX1000B3-B4	04-05	R&L	BCF-424					
KZ1100A1/A2	81-82	R&L	BCF-403	BCR-401	BCP-404	BCP-404	CPK-401(2)	CPK-401(1)
KZ1100A3	83	R&L	BCF-403	BCR-401	BCP-404	BCP-404	CPK-401(2)	CPK-401(1)
KZ1100B	81-82	R&L	BCF-403	BCR-401	BCP-404	BCP-404	CPK-401(2)	CPK-401(1)
KZ1100D1	82-83	R&L	BCF-403	BCR-401	BCP-404	BCP-404	CPK-401(2)	CPK-401(1)
KZ1100L1	83	R&L	BCF-403	BCR-401	BCP-404	BCP-404	CPK-401(2)	CPK-401(1)
ZN1100B1/B2 LTD	84-85	R&L	BCF-406	BCF-408	BCP-411	BCP-411	CPK-407(2)	CPK-407(1)
ZR1100A1-A3	92-94	R&L	BCF-417	BCF-405	BCP-414	BCP-416B BCP-416A	CPK-409(8)	CPK-408U(1) CPK-408L(1)
ZR1100C1-C2	97-98	R&L	BCF-416	BCR-409		BCP-421	U. CPK-417(4) M. CPK-417(4) L. CPK-418(4)	CPK-419(2)
ZR1100C3	99	R&L	BCF-416	BCR-409		BCP-421	U. CPK-417(4) M. CPK-417(4) L. CPK-418(4)	CPK-419(2)
ZR1100D1-D3	97-99	R&L	BCF-416	BCR-409				
ZR1100D4	00	R&L	BCF-416	BCR-409				
ZX1100A1/A2 GPz	83-84	R&L	BCF-406	BCF-408	BCP-411	BCP-411	CPK-407(2)	CPK-407(1)
ZX1100A3	85							
ZX1100C1-C4	90-93	R&L	BCF-417	BCF-405	BCP-414	BCP-416B BCP-416A	CPK-409(8)	CPK-408U(1) CPK-408L(1)
ZX1100D1-D4								
ZZR1100	93-96	R&L	BCF-417	BCR-409	BCP-417	BCP-421	CPK-410(8)	CPK-419(2)
ZX1100D5 ZZR1100	97	R&L	BCF-417	BCR-409	BCP-417	BCP-421	CPK-410(8)	CPK-419(2)
ZX1100D6 ZZR1100	98	R&L	BCF-417	BCR-409	BCP-417	BCP-421	CPK-410(8)	CPK-419(2)
ZX1100D7-D8								
ZZR1100	99-00	R&L	BCF-417	BCR-409	BCP-417	BCP-421	CPK-410(8)	CPK-419(2)
ZX1100E1-E2 GPz	95-96							
ZX1100E3 GPz	97							
ZG1200A1	86	R&L	BCF-406	BCF-408	BCP-411	BCP-411	CPK-407(2)	CPK-407(1)
ZG1200A2	87							
ZG1200B1-B11	87-97	R&L	BCF-406	BCF-408	BCP-411	BCP-411	CPK-407(2)	CPK-407(1)
ZG1200B12	98							
ZX1200A1	00	R&L	BCF-416	BCR-409		BCP-424	U. CPK-417(4) M. CPK-417(4) L. CPK-418(4)	CPK-422(2)
ZX1200A2	02	R&L	BCF-416	BCR-409				
ZX1200B6F	06	R&L	BCF-424					
ZX1200D7F	07	R&L	BCF-424					
KZ1300A1-A4	79-82	R&L	BCF-404	BCR-402	BCP-406	BCP-405	CPK-403(2)	CPK-405(2)
KZ1300B2	80				BCP-406	BCP-405	CPK-403(2)	CPK-405(2)
ZN1300A1-A4 VOYAGER	83-86	R&L	BCF-406	BCF-408	BCP-411	BCP-411	CPK-407(2)	CPK-407(1)
ZN1300A5-A6 VOYAGER	87-88	R&L	BCF-406	BCF-408	BCP-411	BCP-411	CPK-407(2)	CPK-407(1)
VN1500A1-A9	87-95		BCF-408	BCF-408	BCP-411	BCP-411	CPK-407(1)	CPK-407(1)
VN1500A10-A11	96-97		BCF-408	BCF-408	BCP-411	BCP-411	CPK-407(1)	CPK-407(1)
VN1500A12	98							
VN1500B1-B4	87-92		BCF-408	BCF-408	BCP-411	BCP-411	CPK-407(1)	CPK-407(1)
VN1500C	94-97		BCF-408	BCF-408	BCP-411	BCP-411	CPK-407(1)	CPK-407(1)
VN1500D	96-97		BCF-413	BCF-408	BCP-425	BCP-411	CPK-423(2)	CPK-407(1)
VN1500E1	98		BCF-413	BCF-408	BCP-425	BCP-411	CPK-423(2)	CPK-407(1)
VN1500E2	99		BCF-413	BCF-408				
VN1500G1/G2	99-00	R&L	BCF-419	BCF-408				
VN1500J1-J2	99-00		BCF-413	BCF-420				
VN1500L1	00	R&L	BCF-419					
VN1500N1	00		BCF-413		BCP-425		CPK-423(2)	
VN1500N	08		BCF-413	BCR-412	BCP-425		CPK-423(2)	

MODEL	YEAR	CALIPER SEALING KIT				CALIPER PISTON ONLY		CALIPER PISTON KIT			
		FRONT		REAR		FRONT	REAR	FRONT		REAR	
VN1600B2	05	R&L	BCF-424								
VN1600B	07-08	R&L	BCF-424								
VN1600D	08	R&L	(BCF-422		BCR-412	BCP-425				CPK-423(4)	
VN2000 J/H/G	08	R&L	(BCF-421		BCR-412						
SUZUKI											
RM80	86-90		ACS-351								
RM80	91-95		ACS-351								
RM125	89-90		BCF-116		BCR-116					CPK-903(2)	CPK-904
RM125	91		BCF-116		BCR-116					CPK-901(2)	CPK-904
RM125	92		BCF-116		BCR-116					CPK-901(2)	CPK-108
RM125	93-95		BCF-116		ACS-355					CPK-901(2)	CPK-905
RM125	96-08		BCF-116		BCR-116	BCP-430		BCP-431		CPK-901(2)	CPK-108
DR250L/M/N/P	90-93		BCF-116								
DR250S L-N	90-92		BCF-116		BCR-306						
DR250SE P-S	93-95		BCF-116		BCR-306						
DR-Z250	01-04		BCF-116								
GS250TT/TX	80-81		BCF-301								
GSX250F N/P/R	92-94				BCR-304						
RM250	87		BCF-116								
RM250	88		BCF-116							CPK-903(2)	
RM250	89-90		BCF-116		BCR-116					CPK-903(2)	CPK-904
RM250	91		BCF-116		BCR-116	BCP-430				CPK-901(2)	CPK-904
RM250	92		BCF-116		BCR-116	BCP-430		BCP-431		CPK-901(2)	CPK-108
RM250	93-95		BCF-116		ACS-355	BCP-430		BCP-433		CPK-901(2)	CPK-905
RM250	96-08		BCF-116		BCR-116	BCP-430		BCP-431		CPK-901(2)	CPK-108
RM-Z250	04-06		BCF-116		BCR-410						
RM-Z250	07-09		BCF-116			BCP-430				CPK-901(2)	
DR350											
L/M/N/P/R/S/T	90-96		BCF-116								
DR350 V	97		BCF-116								
DR350 W	98		BCF-116								
DR350S	90-93		BCF-116		BCR-306	BCP-432				CPK-903	
DR350SE	94-96		BCF-116		BCR-306	BCP-432				CPK-903	
DR350SE	97-98		BCF-116			BCP-432				CPK-903	
DR-Z400	00-04		BCF-116		BCR-116	BCP-430				CPK-901	
DR-Z400E	00-04		BCF-116		BCR-116	BCP-430				CPK-901	
DR-Z400S	00-04		BCF-116		BCR-116	BCP-430				CPK-901	
DR-Z400S	05-08	A2	BCF-116		BCR-116	BCP-430		BCP-431		CPK-901(2)	CPK-108
DR-Z400SM	08	A2	BCF-116		BCR-116	BCP-430		BCP-431		CPK-901(2)	CPK-108
GSF400FM/FN											
BANDIT	91-92				BCR-304						
GSF400FP BANDIT	93				BCR-304						
GSF400M/N/P											
BANDIT	91-93					BCP-301U				CPK-302U(1)	
						BCP-301L				CPK-302L(1)	
GS450E T/X	80-81		BCF-301							CPK-301(1)	
GS450E Z	82		BCF-301								
GS450E D	83		BCF-301							CPK-301(1)	
GS450GA Z/D	82-83		BCF-301							CPK-301(1)	
GS450GA F	85		BCF-301							CPK-301(1)	
GS450LD	83									CPK-301(1)	
GS450L T/X/Z	80-82		BCF-301							CPK-301(1)	
GS450L D	83		BCF-301								
GS450L F/G/H/J	85-88		BCF-301								
GS450S T/X	80-81		BCF-301							CPK-301(1)	
GS450T X/Z	81-82		BCF-301							CPK-301(1)	
RM-Z450	05-06		BCF-116								
RM-Z450	09	A2	BCF-116			BCP-430				CPK-901(2)	
GS500E K/L/M	89-91				BCR-303	BCP-301U		BCP-303		CPK-302U(1)	CPK-304(2)
						BCP-301L				CPK-302L(1)	
GS500E N	92				BCR-303	BCP-301U				CPK-302U(1)	
						BCP-301L				CPK-302L(1)	
GS500E P/R/S	93-95				BCR-304	BCP-301U		BCP-302		CPK-302U(1)	CPK-303(2)
						BCP-301L				CPK-302L(1)	
GS500E T	96				BCR-304			BCP-302		CPK-317(2)	CPK-303(2)
GS500E V/W/X/Y	97-00		BCF-319		BCR-304					CPK-317(2)	CPK-320(2)
GS500E	01		BCF-319								
GS550E C/N	78-79				BCR-301						
GS550E T	80				BCR-301	BCP-304				CPK-306(1)	
GS550E X	81	R&L	BCF-303		BCR-302						
GS550E D	83	R&L	BCF-314		BCR-303	BCP-303		BCP-303		CPK-304(4)	CPK-304(2)
GS550ES D	83	R&L	BCF-314		BCR-303	BCP-303		BCP-303		CPK-304(4)	CPK-304(2)
GS550ES3/EF	83-84	R&L	BCF-314		BCR-303	BCP-303		BCP-303		CPK-304(4)	CPK-304(2)
GS550ES E/F/G	84-86	R&L	BCF-314		BCR-303	BCP-303		BCP-303		CPK-304(4)	CPK-304(2)
GS550L N/T	79-80				BCR-301						
GS550LX	81				BCR-302	BCP-304				CPK-306(1)	
GS550L Z	82				BCR-302	BCP-304				CPK-306(1)	
GS550L D	83		BCF-315			B CP-303				CPK-304(2)	
GS550L F/G	85-86		BCF-315			B CP-303				CPK-304(2)	
GS550M Z	82	R&L	BCF-303		BCR-302						
GS550T X	81				BCR-301	BCP-304				CPK-306(1)	
GSF600(U/SU) S/T	95-96	R&L	BCF-325		BCR-304			BCP-302		CPK-311(4)	CPK-303(2)

MODEL	YEAR	CALIPER SEALING KIT		CALIPER PISTON ONLY		CALIPER PISTON KIT		
		FRONT	REAR	FRONT	REAR	FRONT	REAR	
							UPTO GN77A105200,GN77B 108963,JS1GN77A00 0502399	
GSF600S S-X BANDIT	96-99	R&L	BCF-325				CPK-311(4)	CPK-320(2)
GSF600S	00-03	R&L	BCF-321				CPK-317(4)	CPK-320(2)
GSR600	06-08	R&L	BCF-327					
GSX600F J	88	R&L	BCF-310			BCP-303	CPK-309(8)	CPK-304(2)
GSX600F K/L/M/N	89-92	R&L	BCF-310			BCP-303	CPK-309(8)	CPK-304(2)
								for 1992 MODELO.use CPK-313(2) for 69100-34C02
GSX600F	93-97	R&L	BCF-310			BCP-302	CPK-309(8)	CPK-303(2)
GSX600F W/X	98-00	R&L	BCF-321				CPK-317(4)	CPK-320(2)
GSX600F	01	R&L	BCF-321				CPK-317(4)	
GSX600F	02-06	R&L	BCF-321				CPK-317(4)	CPK-320(2)
GSX-R600 W N/P	92-93	R&L	BCF-312			BCP-302	CPK-312U(4) CPK-312L(4)	CPK-303(2)
GSX-R600 V/W/X/Y	97-00	R&L	BCF-318				CPK-318U(4) CPK-318L(4)	CPK-320(2)
GSX-R600	01-03	R&L	BCF-326					
GSX-R600	04-05	R&L	BCF-327				CPK-322U(2) CPK-322L(2)	
GSX-R600	06	R&L	BCF-327				CPK-322U(2) CPK-322L(2)	CPK-327(1)
GSX-R600	07						CPK-322U(2) CPK-322L(2)	CPK-327(1)
GSX-R600	08-10	R&L	BCF-329					CPK-327(1)
RF600R P	93	R&L				BCP-302	CPK-311(4)	CPK-303(2)
RF600R R/S/T	94-96	R&L				BCP-302	CPK-311(4)	CPK-303(2)
DR650SE	96-00		BCF-116					
DL650	04-10							
DR650SE K1-K4	01-04		BCF-116					
GS650E X/Z	81-82	R&L	BCF-303			BCP-303		CPK-305(2)
GS650G X/Z/D	81-83	R&L	BCF-303			BCP-303		CPK-305(2)
GS650GL X/Z	81-82					BCP-303	CPK-306(1)	CPK-305(2)
GS650GL D	83					BCP-303	CPK-306(1)	CPK-305(2)
GS650GT X/Z	81-82	R&L	BCF-303					
GS650M D KATANA	83	R&L	BCF-303			BCP-303		CPK-305(2)
GSF650S	05-06	R&L	BCF-321				CPK-317(4)	
GSX650F	08-09							
SV650(U/S/SU)X/Y	99-00	R&L	BCF-321				CPK-317(4)	CPK-320(2)
SV650/S	01-02	R&L	BCF-321	B2			CPK-317(4)	
SV650	03-08	R&L	BCF-321				CPK-317(4)	
XF650(U)V/W	97-98		BCF-319					
GS700E F	85	R&L	BCF-307					
GS700ES F	85	R&L	BCF-307					
GV700GLF/GLF2 MADURA	85	R&L	BCF-307					
GS750 B/C/N	77-79							
GS750E C/N	78-79							
GS750E D	83							
GS750L T/X	80-81	R&L	BCF-307			BCP-303		CPK-305(2)
GS750S D	83							CPK-308(2)
DR750S J	88							
GSX750 T/X	80-81							
GSX750E	80-82	R&L	BCF-307				CPK-307(2)	CPK-308(2)
GSX750E D	83	R&L	BCF-307			BCP-305	CPK-307(2)	CPK-308(2)
GSX750E E	84	R&L	BCF-307			BCP-305	CPK-307(2)	
GSX750EF E	84	R&L	BCF-307			BCP-303	CPK-307(2)	CPK-305(2)
GSX750ES D	83	R&L	BCF-307			BCP-303	CPK-307(2)	CPK-305(2)
GSX750ES E	84	R&L	BCF-307			BCP-303	CPK-307(2)	CPK-305(2)
GSX750F K/L/M/N	89-92	R&L	BCF-310			BCP-303	CPK-309(8)	CPK-304(2)
								for 1992 MODEL.use CPK- 313(2) for 69100- 20C02
GSX750F P/R/S/T	93-96	R&L	BCF-310			BCP-302	CPK-309(8)	CPK-303(2)
GSX750F V	97	R&L	BCF-310			BCP-302	CPK-309(8)	CPK-303(2)
GSX750F W	98	R&L	BCF-321				CPK-317(4)	CPK-320(2)
GSX750F X/Y	99-00	R&L	BCF-321				CPK-317(4)	CPK-320(2)
GSX750F	01-06	R&L	BCF-321				CPK-317(4)	CPK-320(2)
GSX750L N	79							
GSX750L T/X	80-81	R&L	BCF-307			BCP-305		CPK-308(2)
GSX750S D KATANA	83	R&L	BCF-303					
GSX750T Z/D	82-83		BCF-301					
GSX750 W/X/Y	98-00	R&L	BCF-321					
GSX-R750 F	85	R&L	BCF-311					
GSX-R750	86-87	R&L	BCF-311			BCP-308	CPK-314(8)	CPK-304(2)
GSX-R750	88-92	R&L	BCF-312			BCP-303	CPK-312U(4) CPK-312L(4)	CPK-313(2)
GSX-R750	96-99	R&L	BCF-320					
GSX-R750 Y	00-03	R&L	BCF-326					
GSX-R750	04-05	R&L	BCF-327				CPK-322U(4) CPK-322L(4)	
GSX-R750	06	R&L	BCF-327				CPK-322U(4) CPK-322L(4)	CPK-327
GSX-R750	07						CPK-322U(4) CPK-322L(4)	CPK-327
GSX-R750	08-09	R&L	BCF-329				CPK-322U(4) CPK-322L(4)	CPK-327

MODEL	YEAR	CALIPER SEALING KIT				CALIPER PISTON ONLY		CALIPER PISTON KIT		
		FRONT		REAR		FRONT	REAR	FRONT		REAR
GSX-R750	10	R&L	BCF-329							
GSX-R750RG	86				BCR-303	BCP-308		BCP-303	CPK-314(8)	CPK-304(2)
GSX-R750W N	92-93	R&L	BCF-312					BCP-302	CPK-312U(4)	CPK-303(2)
									CPK-312L(4)	
GSX-R750W R/S	94-95	R&L	BCF-313		BCR-304			BCP-302	CPK-315(12)	CPK-303(2)
VS800	06-09				BCR-311					
VS800GL	01-03				BCR-311					
VS800GL	04-05		BCR-305		BCR-311					
VX800(U)L-V	90-94					BCP-301U BCP-301L			CPK-302U(1) CPK-302L(1)	
VL800	06-08		BCF-413							
VZ800V MARAUDER	97		BCF-319							
VZ800 W/X/Y	98-00		BCF-319							
VZ800	05-08		BCF-413							
GS850G N	79				BCR-301					
GS850G T/X	80-81	R&L	BCF-307		BCR-301	BCP-305			CPK-307(2)	
GS850G Z/D	82-83	R&L	BCF-307		BCR-302	BCP-305		BCP-303	CPK-307(2)	CPK-305(2)
GS850G E	84	R&L	BCF-307		BCR-302					
GS850GL T/X	80-81	R&L	BCF-307		BCR-301	BCP-305			CPK-307(2)	
GS850GL Z/D	82-83	R&L	BCF-307		BCR-301	BCP-305			CPK-307(2)	CPK-308(2)
RF900R R/S	94-95	R&L	BCF-312		BCR-304			BCP-302	CPK-312U(4) CPK-312L(24)	CPK-303(2)
RF900R T/V	96-97	R&L	BCF-312		BCR-304				CPK-312U(4) CPK-312L(4)	
DL1000	02-06				BCR-310					
DL1000	07-08	R&L	BCF-321		BCR-310				CPK-317(4)	
DL1000	09-10				BCR-310					
GS1000 C/N	78-79				BCR-301					
GS1000 T	80	R&L	BCF-303		BCR-301					
GS1000E C/N	78-79				BCR-301					
GS1000E T	80	R&L	BCF-303		BCR-301					CPK-308(2)
GS1000G T/X	80-81	R&L	BCF-307		BCR-301	BCP-305			CPK-307(2)	CPK-308(2)
GS1000GL T/X	80-81	R&L	BCF-307		BCR-301	BCP-305			CPK-307(2)	CPK-308(2)
GS1000H C/N	78-79				BCR-301					
GS1000H T	80	R&L	BCF-303		BCR-301					
GS1000L N	79				BCR-301					
GS1000S N	79				BCR-301					
GS1000S T	80	R&L	BCF-303		BCR-301					CPK-308(2)
GS1000S Z	82	R&L	BCF-303		BCR-301					CPK-308(2)
GS1000S D	83	R&L	BCF-303		BCR-301					
GSX-R1000	03	R&L	BCF-328		BCR-308					
GSX-R1000	04				BCR-308					
GSX-R1000	05-06	R&L	BCF-327		BCR-308				CPK-322U(4) CPK-322L(4)	
GSX-R1000	07-08	R&L	BCF-327		BCR-309				CPK-322U(4) CPK-322L(4)	CPK-327(1)
SV1000	03-07				BCR-310				CPK-326U(4) CPK-326L(4)	
SV1000	08-10				BCR-310					
TL1000R	98-03	R&L	BCF-320		BCR-304					CPK-320(2)
TL1000S V/W/X/Y	97-00	R&L	BCF-318		BCR-304				CPK-318U(4) CPK-318L(4)	CPK-320(2)
GS1100G E/F/G	84-86	R&L	BCF-307		BCR-302	BCP-305		BCP-303	CPK-307(2)	CPK-305(2)
GS1100GL Z/D	82-83					BCP-305			CPK-307(2)	CPK-308(2)
GS1100K Z/D	82-83									
GS1100L T	80									CPK-308(2)
GS1100S Z	82									CPK-308(2)
GS1100S D	83									
GSX1100E	80-83	R&L	BCF-303		BCR-301					
GSX1100E E/F/G	84-86	R&L	BCF-309		BCR-302					
GSX1100ES D	83	R&L	BCF-303		BCR-301					
GSX1100ES E/F/G	84-86	R&L	BCF-309		BCR-302					
GSX1100EF E/F/G	84-86	R&L	BCF-309		BCR-302					
GSX1100F J/K/L/M/N	88-92	R&L	BCF-309		BCR-302	BCP-307		BCP-303	CPK-310(4)	CPK-305(2)
GSX1100F P	93				BCR-304			BCP-302		CPK-303(2)
GSX1100G Z/D	82-83	R&L	BCF-307		BCR-302					
GSX1100G M/N	91-92	R&L				BCP-301U BCP-301L BCP-301U BCP-301L			CPK-302U(2) CPK-302L(2) CPK-302U(2) CPK-302L(2)	
GSX1100G P/R	93-94	R&L								
GSX1100L T	80	R&L	BCF-303		BCR-301					
GSX1100S E	84	R&L	BCF-303		BCR-301					
GSX-R1100 G/H/J	86-88	R&L	BCF-311		BCR-303	BCP-308		BCP-303	CPK-314(8)	CPK-304(2)
GSX-R1100 K/L	89-90	R&L	BCF-312		BCR-303			BCP-303	CPK-312U(4) CPK-312L(4)	CPK-313(2)
GSX-R1100 M/N	91-92				BCR-303			BCP-303	CPK-312U(4) CPK-312L(4)	CPK-313(2)
GSX-R1100W P/R	93-94	R&L	BCF-313		BCR-304			BCP-302	CPK-315(12)	CPK-303(2)
GSX-R1100W S/T	95-96	R&L	BCF-313		BCR-304			BCP-302	CPK-315(12)	CPK-303(2)
GSX-R1100W V	97	R&L	BCF-313		BCR-304					
GSX-R1100W W	98	R&L	BCF-313		BCR-304					
GS1150ES3/ESE/ESF/ESG	86	R&L	BCF-309		BCR-302					
GSF1200(S)T-Y	96-00	R&L	BCF-312		BCR-304				CPK-312U(4)	CPK-320(2)

MODEL	YEAR	CALIPER SEALING KIT		CALIPER PISTON ONLY		CALIPER PISTON KIT		
		FRONT	REAR	FRONT	REAR	FRONT	REAR	
GSF1200	01-02	R&L	BCF-320		BCR-304		CPK-312L(4) CPK-323UM(8) CPK-323L(4)	CPK-328(2)
GSF1200	03-05						CPK-323UM(8) CPK-323L(4)	CPK-328(2)
GSF1250	07-10	R&L	BCF-330		BCR-310			
GV1200GL F/G	85-86	R&L	BCF-307					
GSX1300R X	99	R&L	BCF-320		BCR-304			CPK-320(2)
GSX1300R Y	00	R&L	BCF-320		BCR-304			CPK-320(2)
GSX1300R	01-02	R&L	BCF-320		BCR-304		CPK-324-UM(8) CPK-324-L(4)	
GSX1300R	08-09				BCR-309		CPK-324-UM(8) CPK-324-L(4)	
GSX1400	02-07				BCR-308		CPK-325-UM(8) CPK-325-L(4)	
VS1400GLP T/V	96-97				BCR-305			
VS1400GLP W/X/Y	98-03				BCR-305			
VS1400GLP	04-08				BCR-311			
VL1500	98-01				BCR-311			
VL1500	05-08	R&L	BCF-321					

YAMAHA

YZ125	89		ACY-253/BCF-116	ACY-254	BCP-432		CPK-903(2)	
YZ125	90-91		ACY-253/BCF-116	ACY-254	BCP-432		CPK-903(2)	CPK-906
YZ125	92		ACY-253/BCF-116	ACY-254	BCP-432		CPK-903(2)	CPK-906
YZ125	93-95		ACY-253/BCF-116	ACY-254	BCP-430		CPK-901(2)	CPK-906
YZ125	96-97		ACY-253/BCF-116	ACY-254	BCP-430		CPK-901(2)	CPK-906
YZ125	98		ACY-253/BCF-116	ACY-253	BCP-430		CPK-901(2)	
YZ125	99		ACY-253/BCF-116		BCP-430		CPK-901(2)	CPK-108
YZ125	00		ACY-253/BCF-116		BCP-430		CPK-901(2)	CPK-108
YZ125	01		ACY-253/BCF-116		BCP-430		CPK-901(2)	CPK-108
YZ125	02		ACY-253/BCF-116		BCP-430		CPK-901(2)	CPK-108
YZ125	03-04		ACY-253/BCF-116					
YZ125	05-06		BCF-116					
TZR250	88							
TZR250	89-90							
WR250ZJ	97		ACY-253/BCF-116		BCP-430		CPK-901(2)	CPK-906
WR250F	01		ACY-253/BCF-116		BCP-430		CPK-901(2)	CPK-108
WR250F	02		ACY-253/BCF-116		BCP-430		CPK-901(2)	CPK-108
WR250F	03-08		BCF-116					
YZ250	89		ACY-253/BCF-116	ACY-254				
YZ250	90-91		ACY-253/BCF-116	ACY-254	BCP-432		CPK-903(2)	CPK-906
YZ250	92		ACY-253/BCF-116	ACY-254	BCP-432		CPK-903(2)	CPK-906
YZ250	93-95		ACY-253/BCF-116	ACY-254	BCP-430		CPK-901(2)	CPK-906
YZ250	96-97		ACY-253/BCF-116	ACY-254	BCP-430		CPK-901(2)	CPK-906
YZ250	98		ACY-253/BCF-116	ACY-253	BCP-430		CPK-901(2)	
YZ250	99-00		ACY-253/BCF-116		BCP-430		CPK-901(2)	CPK-108
YZ250	01		ACY-253/BCF-116		BCP-430		CPK-901(2)	CPK-108
YZ250	02		ACY-253/BCF-116		BCP-430		CPK-901(2)	CPK-108
YZ250	03-06		ACY-253/BCF-116					
YZ250F	01		ACY-253/BCF-116		BCP-430		CPK-901(2)	CPK-108
YZ250F	02		ACY-253/BCF-116		BCP-430		CPK-901(2)	CPK-108
YZ250F	03-04		ACY-253/BCF-116					
YZ250F	05-06		BCF-116					
RD350LC	82				BCP-201		CPK-201(2)	
FZR400 W/U	88-89	R&L	BCF-208		BCP-202		CPK-202(4)	
XS400 D/E/F	77-79		BCF-201	BCF-201				
XS400S G	80		BCF-205					
XS400S H	81		BCF-205					
YZ400	98		ACY-253/BCF-116	ACY-254				
YZ400	99		ACY-253/BCF-116	ACY-253				
YZ426F	01		ACY-253/BCF-116				CPK-901(2)	CPK-108
YZ426F	02		ACY-253/BCF-116				CPK-901(2)	CPK-108
WR426F	01		ACY-253/BCF-116				CPK-901(2)	CPK-108
WR426F	02		ACY-253/BCF-116				CPK-901(2)	CPK-108
WR450F	08		BCF-116					
YZ450F	03-04		ACY-253/BCF-116					
YZ450F	05-06		BCF-116					
SR500E/F/G/H	78-81		BCF-201	BCF-201				
XS500 C/D/E	76-78		BCF-201	BCF-201				
XJ550	83	R&L	BCF-204		BCP-201		CPK-201(2)	
XJ550 H/J/K MAXIM (USA)	81-83		BCF-203		BCP-201		CPK-201(1)	
XJ550RH (USA)	81		BCF-203					
XJ550RJ/RK (USA)	82-83		BCF-203		BCP-201		CPK-201(1)	
FJ600 L/N	85-86	R&L	BCF-208		BCP-202		CPK-202(4)	
FJ600 U	88	R&L	BCF-208		BCP-202		CPK-202(4)	
FZ600 S/T	86-87				BCP-202		CPK-202(4)	
FZR600 W	89	R&L	BCF-212	BCR-202				
FZR600 A/B	90-91	R&L	BCF-212	BCR-202	BCP-204	BCP-202	CPK-204U(4)	CPK-202(2)
FZR600 D	92	R&L	BCF-212	BCR-202	BCP-204	BCP-202	CPK-204L(4) CPK-204U(4)	CPK-202(2)

MODEL	YEAR	CALIPER SEALING KIT		CALIPER PISTON ONLY		CALIPER PISTON KIT	
		FRONT	REAR	FRONT	REAR	FRONT	REAR
FZR600R E	93	R&L BCF-212	BCR-202	BCP-205 BCP-204	BCP-202	CPK-204L(4) CPK-204U(4)	CPK-202(2)
FZR600R F/G	94-95	R&L BCF-212	BCR-202	BCP-205 BCP-204	BCP-202	CPK-204L(4) CPK-204U(4)	CPK-202(2)
FZR600R H	96	R&L BCF-212	BCR-202	BCP-205 BCP-204	BCP-202	CPK-204L(4) CPK-204U(4)	CPK-202(2)
FZR600R J	97	R&L BCF-212	BCR-202	BCP-205 BCP-204	BCP-202	CPK-204L(4) CPK-204U(4)	CPK-202(2)
FZR600R K	98	R&L BCF-212	BCR-202	BCP-205		CPK-204L(4)	
FZR600 4JH/4HM	94-95	R&L BCF-212	BCR-202	BCP-204 BCP-205	BCP-202	CPK-204U(4) CPK-204L(4)	CPK-202(2)
FZS600	98-03	R&L(B BCF-214				U. CPK-208U(4) L. CPK-208L(4)	
XT600E	91-02					CPK-209	
XT600K	91-93					CPK-209	
YZF600R	96-99		BCR-202		BCP-202		CPK-202(2)
YZF600R	00-05	R&L(B BCF-214	B2 BCR-202			CPK-208U(4) CPK-208L(4)	CPK-202(2)
YZF-R6	99-00	R&L(B BCF-214				CPK-208U(4) CPK-208L(4)	
YZF-R6	01-04					CPK-208U(4) CPK-208L(4)	
YZF-R6	05-08					CPK-212U(4) CPK-212L(4)	
YZF-R6S	08	BCF-214				CPK-208U(4) CPK-208L(4)	
FZ6	04-07		BCR-203				CPK-213
FZ6 FAZER	04-07		BCR-203				CPK-213
FZ6 S2	07-08	BCF-214	BCR-203			CPK-208U(4) CPK-208L(4)	CPK-213
FZ6 S2 FAZER	08	BCF-214				CPK-208U(4) CPK-208L(4)	
XJ650 G	80	BCF-205					
XJ650 H/J	81-82	BCF-205					
XJ650LH	81	BCF-205					
XJ650LJ/LK	82-83						
XJ650RJ SECA	82	R&L BCF-202					
XS650 D/E/F single disc	77-79	BCF-201					
XS650 E/E/F double disc	77-79	BCF-202					
XS650 double discs	80	BCF-202					
XS650G special II	80	BCF-201					
XS650H single disc	81	BCF-201					
XS650H double disc	81	BCF-202					
XS650S E/F/G single disc	78-80	BCF-201	BCF-201				
XS650S E/F/G double disc	78-80	BCF-202	BCF-201				
XS650S H	81	BCF-201					
XS650SJ/SK single disc	82-83	BCF-201					
XS650SJ/SK double discs	82-83	BCF-202					
XTZ660 TENERE	91-96					CPK-210(2)	
FZ750 N	85		BCR-202				
FZR750RT/RU	87-88	R&L BCF-213	BCR-202	BCP-203	BCP-202	CPK-203(8)	CPK-202(2)
XJ750R H SECA	81	R&L BCF-204		BCP-201		CPK-201(2)	
XJ750R J SECA	82	R&L BCF-204					
XJ750R K SECA	83	R&L BCF-204					
XS750 D/2D/E/F	77-79	R&L BCF-202	BCF-201				
XS750S E/F	78-79	R&L BCF-206	BCF-201				
XTZ750	89-95					CPK-211(2)	
XV750	82	BCF-205					
XV750	92	R&L BCF-207					
TDM850 D/E	92-93	R&L BCF-213	BCR-202	BCP-203	BCP-202	CPK-203(8)	CPK-202(2)
TDM850	94-95	R&L BCF-213	BCR-202	BCP-203	BCP-202	CPK-203(8)	CPK-202(2)
TDM850	96-99	R&L BCF-212	BCR-202	BCP-204 BCP-205 BCP-203	BCP-202	CPK-204U(4) CPK-204L(4) CPK-203(8)	CPK-202(2)
TRX850	96						
XS850 G/H	80-81	R&L BCF-202	BCF-201				
XS850L G/H	80-81	R&L BCF-206	BCF-201				
XS850S F	79	BCF-201	BCF-201				
XS850S G/H	80-81	R&L BCF-206	BCF-201				
TDM900	08	R&L BCF-214				CPK-208U(4) CPK-208L(4)	
XJ900F N		R&L BCF-208	BCR-202				
XJ900R K	83	R&L BCF-208	BCR-202				
XJ900S	95		BCR-202				
XJ900S/SN	01		BCR-202				
FZR1000 T/U	87-88	R&L BCF-213	BCR-202	BCP-203	BCP-202	CPK-203(8)	CPK-202(2)
FZR1000 W/A	89-90	R&L BCF-210	BCR-202	BCP-204 BCP-205	BCP-202	CPK-204U(4) CPK-204L(4)	CPK-202(2)
FZR1000 B	91	R&L BCF-210	BCR-202	BCP-204 BCP-205	BCP-202	CPK-204U(4) CPK-204L(4)	CPK-202(2)
FZR1000 D	92	R&L BCF-210	BCR-202	BCP-204 BCP-205	BCP-202	CPK-204U(4) CPK-204L(4)	CPK-202(2)
FZR1000 E	93	R&L BCF-210	BCR-202	BCP-204 BCP-205	BCP-202	CPK-204U(4) CPK-204L(4)	CPK-202(2)

MODEL	YEAR	CALIPER SEALING KIT		CALIPER PISTON ONLY		CALIPER PISTON KIT		
		FRONT	REAR	FRONT	REAR	FRONT	REAR	
FZR1000 F	94			BCR-202		BCP-202		CPK-202(2)
FZR1000 G	95			BCR-202		BCP-202		CPK-202(2)
FZS1000	01-05	R&L(B	BCF-214				U.CPK-208U(4) L.CPK-208L(4)	
FZ1 FAZER	06-09	R&L	BCF-214	BCR-203			CPK-208U(4)	CPK-213
FZ1	06-09	R&L	BCF-214	BCR-203			CPK-208L(4) CPK-208U(4) CPK-208L(4)	CPK-213
GTS1000	93-94					BCP-202		CPK-202(2)
XV1000	82	R&L	BCF-202					
XV1000SE	83	R&L	BCF-204					
YZF1000R	96-01	R&L(B	BCF-214	BCR-202			CPK-208U(4) CPK-208L(4)	CPK-202(2)
YZF-R1	98-99	R&L	BCF-214				CPK-208U(4) CPK-208L(4)	
YZF-R1	00-01	R&L	BCF-214				CPK-208U(4) CPK-208L(4)	
YZF-R1	02-03	R&L	BCF-215	BCR-203			CPK-212U(4) CPK-212L(4)	CPK-214
YZF-R1	04-06	R&L	BCF-215	BCR-203			CPK-212U(4) CPK-212L(4) CPK-212L(4)	CPK-214
YZF-R1SP	06						CPK-212U(4) CPK-212L(4)	
FJ1100 L/N	84-85	R&L	BCF-208	BCR-202	BCP-202	BCP-202	CPK-202(4)	CPK-202(2)
XS1100 E/F/G/H	78-81	R&L	BCF-202					
XS1100L G MIDNIGHT SPECIAL	80	R&L	BCF-206	BCF-201				
XS1100L H MIDNIGHT SPECIAL	81	R&L	BCF-204					
XS1100S F/G	79-80	R&L	BCF-206	BCF-201				
XS1100S H	81			BCF-201				
XV1100	89-92	R&L	BCF-207		BCP-206		CPK-205(4)	
XVS1100	99-00			BCR-202				
FJ1200 S/T	86-87	R&L	BCF-208	BCR-202				
FJ1200 U	88			BCR-202				
FJ1200 W/A/B/D	89-92	R&L	BCF-213	BCR-202	BCP-203	BCP-202	CPK-203(8)	CPK-202(2)
FJ1200 AD/E	92-93	R&L	BCF-213	BCR-202				
VMX12N/S/U/W V-MAX	85-89	R&L	BCF-211	BCR-202	BCP-207	BCP-202	CPK-206(4)	CPK-202(2)
VMX12A/B/D	90-92	R&L	BCF-211	BCR-202	BCP-207	BCP-202	CPK-206(4)	CPK-202(2)
VMX12E/EC V-MAX	93	R&L	BCF-212	BCR-202	BCP-204 BCP-205	BCP-202	CPK-204U(4) CPK-204L(4)	CPK-202(2)
VMX12F/FC/G/GC V-MAX	94-95	R&L	BCF-212	BCR-202	BCP-204 BCP-205	BCP-202	CPK-204U(4) CPK-204L(4)	CPK-202(2)
VMX12H/HG/J/JC V-MAX	96-97	R&L	BCF-212	BCR-202	BCP-204 BCP-205	BCP-202	CPK-204U(4) CPK-204L(4)	CPK-202(2)
XJR1200	95	R&L	BCF-213	BCR-202	BCP-203	BCP-202	CPK-203(8)	CPK-202(2)
XVZ12DL/DKC2								
VENTURE ROYALE	84	R&L	BCF-207		BCP-206		CPK-205(4)	
XVZ12DN VENTURE ROYALE	85	R&L	75		BCP-206		CPK-205(4)	
XVZ12L/KC2	84	R&L	BCF-207		BCP-206		CPK-205(4)	
XVZ12TDK	83	R&L	BCF-207		BCP-206		CPK-205(4)	
XVZ12TK	83	R&L	BCF-207		BCP-206		CPK-205(4)	
FJR1300A	03-05	R&L(B	BCF-214				CPK-208U(4) CPK-208L(4)	

REMARKS:

DRF-436/438... ** ROUND TYPE (NOT WAVE ROTOR)
BCF-214/215 BYPASS 'O' RING NOT INCLUDED

FOLLOWINGS ARE NO LONGER AVAILABLE

BCP-306/BCP-403/BCP-418/BCP-422
CPK-316/CPK-411/CPK-420

BRAKE DISC ROTORS

* Stainless steel made
 * Tourmax disc rotors are made symmetrical and can be used for both LEFT and RIGHT side(EXCPET DRF-316R,DRF316L)
 *TOURMAX Brake Disc Rotors are developed based on **ADVANCED-INTEGRATED-DESIGN-SYSTEM** which can provide complete analysis on Thermal deformation and thermal stress, Load and Vibration.
 After TUV test, Models mentioned () are approved by German KBA (ABE)
Discs with ABE numbers are only supplied to nominated German importer



KAWASAKI

COMPARABLE TO O.E.M. QUALITY

STOCK NO.		MODEL		ABE
DRF-401	FRONT	ZX750H1-H2 ZXR750<ZX750H>	89-90	*
floating disc		ZX1100C1-C4 ZZR1100<ZXT10C>	90-92	*
DRF-403	FRONT	ZL400A ELIMINATOR	86-87	
solid		EX500A1-A6	87-92	
		GPZ500S <EX500A>	87	*
		EX500D1-D8	94-01	
		GPZ500S <EX500D>	94	*
		ER5 <ER500A>	96	*
		ZL600A1/A2 ELIMINATOR	86-87	
		ZL600A <ZL600A>	86	*
		ZX750G2-G3	85-86	
		ZX750E1/E2 TURBO	84-85	
		GPZ750 TURBO <ZX750E>	83-86	*
		ZX900A1-A6	84-89	
		GPZ900R <ZX900A>	84	*
		ZL900A1-A2 ELIMINATOR	85-86	
		ZL900 <ZL900A>	85-87	*
		ZX1000A1-A3 GPZ1000RX	85-87	
		GPZ1000RX <ZX1000A>	87	*
		GPZ1100UT <ZXT10A>	83-87	*
		ZX1100A1-A3	83-85	
		ZL1000A1	87	*
DRF-404	FRONT	ZX800A1-A3 NINJA	85-87	
solid		GPX600R <ZX600A>	85	*
		ZX600B1 NINJA	87	
		ZX750A1-A5	83-87	
		ZG1000A1-A8 CONCOURS	86-93	
		GTR1000 <ZGT00A>	86	*
DRF-405	FRONT	EX250H1-1H5	90-94	
floating		EX250H12-H13	01-02	
		ZRX400<ZX400L>	95	*
		ZR400C3 ZEPHYR	91	
		ZX400J2/H2	90	
		ZX400K1-K3	90-92	
		ZR550B1-B5 ZEPHYR	90-94	
		ZEPHYR 550 <ZR550B>	92	*
		ZL600 ELIMINATOR <ZL600B>	96-97	*
		ZX600D1-D3 ZZR600<ZX600D>	90-92	*
		ZX600D4	93	
		ZX800F1-F3 <ZX800F> ZX-6R	95-97	*
		ZR750C1-C4 ZEPHYR<ZR750C>	91-94	*
		ZR750F1-F3	99-01	
		ZR750H1/H3 ZR-7S	01-03	
		ZX900A7-A8 GPZ900R<ZX900A>	90-93	*
		ZG1000A9-A15	94-00	
		GTR1000<ZGT00A>*	94-99	*
DRF-406	FRONT	Z550G1-G9 GT550	83-91	
solid		GT550 <KZ550G>	83-92	*
DRF-407	FRONT	ZX800E1-E6<ZX800E> ZZR600*	93-98	*
floating		ZX800E7-E11	99-03	
DRF-408	FRONT	ZX750J1-J2 ZXR750<ZX750J>	91-92	*
floating		ZX750K1-K2 NINJA ZX-7R	91-92	
		ZX750M1-M2 NINJA ZX-7R	93-94	
		ZX750L1-L3 ZXR750<ZX750L>	93-95	*
		ZX750N1/N2 ZX-7R<ZX750N>	96-97	*
		ZX900B1-B2 ZX-9R<ZX900B>	94-95	*
		ZX900B3-B4 ZX-9R	96-97	
		ZX1100D1-D8 ZZR1100<ZXT10D>	93-00	
		ZZR1100 <ZXT10D>	93	*
DRF-409	FRONT	Z250P1-P4	83-86	
solid		Z250A1-A3	79-81	
		KZ440A4 LTD	83	
		Z440LTD <KZ440A>	83-86	*
		KZ440D5-D6 LTD	83-84	
		KZ440G1	82	
		Z550LTD <KZ550B>	81-83	*
		GPZ550 <KZ550B>	81	*
		KZ550D1	81	
		KZ650F2-F4	81-83	
		KZ700A1	85	
		VN700A1 VULCAN	85	
		KZ750E1-E3	80-82	
		KZ750F1 LTD	83	
		KZ750H1-H4	80-83	
		KZ750L1-L4	81-84	
		KZ750N1-N2	82-83	
		KZ750 R1	82	
		GT750P1-P9	81-90	
		VN750A2-A16 VULCAN	86-00	
		VN750 VULCAN <VN750A-D>	86-93	*

STOCK NO.		MODEL		ABE
DRF-410	FRONT	KMX125A1-A7	86-96	
DRF-KX1	FRONT	KX125	92-02	
floating		KX250	92-02	
		KDX250D2/D3/D4	92-94	
		KLX250D2-D4	94-96	
		KLX300A2-A5	97-00	
		KX500	93-02	
		KLX650A1-A3	93-95	
		KLX650D1	96	
DRF-KX1R	FRONT	Same as DRF-KX1		
DRF-411	FRONT	EL250B1-B3	87-89	
solid		EL250 <EL250B>	88	*
		EL250C1	89	
		EL250D4/D5		
		ZX550A1-A4		
		GPZ550UT <ZX550>	87-87	*
DRF-412	FRONT	EN400A1-A2	85-86	
solid		EN400B1	90	
		Z400-K LTD		
		EN450A1-A6	85-90	
		EN500A1-A7	90-96	
		KZ550A2-A4	81-83	
		KZ550C1-C4	80-83	
		KZ550M1 LTD	83	
		KZ550F1/F2	83-84	
		KZ1000J1/J2/J3	81-83	
		KZ1000K1/K2	81-82	
		KZ1100A1-A3	81-83	
		KZ1100B1	81	
		KZ1100D1/D2	82-83	
		KZ1100L1 LTD	83	
DRF-KX2	FRONT	KX80	92-97	
Solid	*steel	KX100	95-97	
DRF-414	FRONT	ZX600G1/G2 NINJA ZX-6R	98-99	
floating		ZX600J1-J2	00-01	
		ZX636A1	02	
DRF-440		ZX900C1/G2	98-99	
floating				
DRF-415	FRONT	EN500C1-C5	96-00	
solid		VN800A1-A6	95-00	
		VN1500C3/C4	96-97	
DRF-416	FRONT	VN800B1-B5 VULCAN	96-00	
solid		VN1500D1-D2	96-97	
		VN1500D1/D2	96-97	
DRF-417	FRONT	ZG1200B1-B14	87-00	
solid		ZG1200A1/A2	86-87	
DRF-418	FRONT	ZX900C3	00	
floating		ZX900E1/E2	00-01	
		ZR1100C3/C4 ZRX1100	98-00	
		ZR1100D4	00	
		ZR1200A1-A5 ZRX1200	01-05	
		ZR1200B1-B3	01-03	
		ZR1200C1/C2	01-03	
DRF-419	FRONT	ZX1200	00-01	
floating		ZX1200A2	02	
		ZX1200B1/B2	02-03	
		ZX900F1/F2	02-03	
DRF-420	FRONT	ZR1100G1/G2 ZRX1100	97-98	
floating		ZR1100D1-D3 ZRX1100	97-99	
DRF-421	FRONT	KX85 A1/A8	01-08	
*steel		KX100 D1-D8	01-08	
DRF-422	FRONT	KDX200 H1-H8	95-02	
		KDX220 A4-A9	97-02	
DRF-423	FRONT	KL650A1-A16	87-07	
DRF-424	FRONT	ZX600C1-C9 GPX600R	88-96	
solid	RH ONLY			
DRF-439	FRONT	ZX600C1-C9 GPX600R	88-96	
solid	LH ONLY			
DRF-425	FRONT	ZX750F1-F3 GPX750R	87-89	
solid	LH ONLY			
DRF-426	FRONT	EX250F2-F14	88-00	
Solid				
DRF-427	FRONT	ZX636B1/B2 ZX-6R	03-04	
floating		ZX600K1/K2 ZX-6RR	03-04	
DRF-428	FRONT	ZX-10R	04	
floating		* ROUND TYPE (NOT WAVE TYPE)		
DRF-429	FRONT	EX500B1-B5	88-91	
Solid		EX500E1-E9	94-02	
DRF-430	FRONT	ER250B1-B2		
Solid				

STOCK NO.		MODEL		ABE
DRF-431	FRONT	AR125A1-A7	83-89	
Solid		AR125B1-B8	84-94	
DRF-432	FRONT	ER500D1 ER-5	01	
Solid		ER500C1/C3	01-03	
DRF-434	FRONT	ZX1200C3-C4 ZZR1200	04-05	
DRF-435	FRONT	ZX800N1 ZX-6RR	05	
Floating		ZX800P	08	
DRF-436	FRONT	ZX836C1 ZX-6R	05	
Floating		* ROUND TYPE (NOT WAVE TYPE)		
DRF-437	FRONT	ZR1000A1-A3 Z1000	03-05	
Floating				
DRF-KS1	FRONT	KX125M1-M3	03-05	
		KX250M1/M2	03-04	
		KX250R1	05	
		KX250F	05	
		RM-Z250K4/K6	04-06	
DRR-401	REAR	ZX750P1-P5 ZX-7R	96-00	
solid		ZX750J1-J2 ZX-7	91-92	
		ZXR750 <ZX750J>	91-92 *	
		ZX750H1-H2 ZXR750	89-90	
		ZXR750 <ZX750H>	89-90 *	
		ZX750K1-K2 ZX-7R	91-92	
		ZX750M1-M2 ZX-7R	93-94	
		ZX750N1/N2 ZX-7RR	96-97	
		ZX7R <ZX750N>	96-97 *	
		ZX750L1-L3	93-95	
		ZXR750 <ZX750L>	93-95 *	
		ZX900B1-B4	94-97	
		ZX9R <ZX900B>	94-95 *	
DRR-402	REAR	ZX900A7-A8 NINJA GPZ900R	90-91	
solid		GPZ900R <ZX900A>	90-93 *	
		ZX1100C1-C4 NINJA ZX-11	90-93	
		ZZR1100 <ZXT10C>	90-92 *	
		ZX1000B1-B3 ZX-10	88-90	
		ZX10 <ZXT00B>	88-92 *	
DRR-403	REAR	ZX750E1/E2 TURBO	84-85	
solid		GPZ750 TURBO <ZX750E>	83-86 *	
		ZX750G2-G3	85-86	
		ZX900A1-A6	84-89	
		GPZ900R <ZX900A>	84	
		ZL900A1/A2	85-86	
		ZL900 <ZL900A>	85-87 *	
		ZX1100A1-A3 GPZ	83-85	
		GPZ1100UT <ZXT10A>	83-87 *	
		ZL1000A1 ELIMINATOR	87	
		ZL1000 <ZL100A>	87 *	
DRR-404	REAR	Z400-K LTD		
solid		KZ550D1	81	
		Z550D <KZ550B>	81 *	
		Z850D	79-81	
		KZ700A1	84	
		KZ750F1 LTD	83	
		KZ750H1-H4 LTD	80-83	
		KZ750E1-E3	80-82	
		GPZ750 <KZ750E>	80-84 *	
		KZ750L1-L4	81-84	
		KZ750N1/N2	82-83	
		KZ750R1	82	
		GT750P1-P9	82-90	
		GT750 <KZ750P>	81-92	
		KZ750F1 LTD	83	
		VN1500A/C <VNT50D>	95 *	
DRR-405	REAR	KZ1000J1-J3	81-83	
solid		KZ1000R1-R2 REPLICA	82-83	
		Z1000J/R <KZT00J>	81-86 *	
		KZ1000K1-K2 LTD	81-82	
		KZ1000M1-M2	81-82	
		KZ1100A1-A3	81-83	
		KZ1100B1-B2	81-82	
		Z1100A,B LTD <KZT10A>	81-86 *	
		Z1100GP <KZT10B>	81-88 *	
		GPZ1100B <KZT10B>	81-88 *	
		KZ1100D1-D2	82-83	
		KZ1100L1 LTD	83	
		KZ1000P1-P17	82-98	
		VN1500A1-A12 VULCAN	87-98	
		VN1500B1-B4 VULCAN	87-90	
DRR-406	REAR	KMX125A1-A7	86-96	
solid		KMX200	87-96	
DRR-KX1	REAR	KX125	89-90	
		KDX200E1-E6	89-94	
		KX250	89-90	
		KX500	89-90	
DRR-407	REAR	ZX400A1/A2	83-84	
solid		ZX550A1-A4		
DRR-408	REAR	ZX400H1/H2	89-90	
solid		ZX400J2	90	
		ZX400L1-L5	91-95	
		ZX400 <ZX400L>	95 *	
		ZR550B2-B5	91-94	
		ZEPHYR 550 <ZR550B>	92 *	
		ZX800D1-D3	90-92	
		ZX800E1-E11	93-03	
		ZZR800 <ZX800E>	93 *	
		ZR750C1-C5	91-95	
		ZR750D1	96	

STOCK NO.		MODEL		ABE
DRR-409	REAR	ZX1100D1-D8 ZX-11R	93-00	
Solid		ZZR1100 <ZXT10D>	93	*
DRR-410	REAR	ZX600F1-F3 ZX-6R	95-97	*
Solid				
DRR-411	REAR	ZX1000A1-A3 GPZ1000RX	86-88	
Solid		GPZ1000RX <ZXT00A>	87	
DRR-KX2	REAR	KX80	96-97	
Solid		KX100	95-97	
DRR-412	REAR	ZX600G1/G2	98-99	
Solid		ZX600J1-J2	00-01	
		ZX600K1 ZX-6R	03	
		ZX638A1	02	
		ZX636B1 ZX-6RR	03	
		ZX900C1/G2	98-99	
		ZX900F1/F2	02-03	
		ZX900E1/E2	00-01	
		ZR1000A1-A3 Z1000	03-05	
DRR-413	REAR	ZG1000A1-A15	86-00	
DRR-414	REAR	ZG1200B1-B14	87-00	
		ZG1200A1-A2	86-87	
DRR-415	REAR	VN1500E1-E3	98-00	
		VN1500C3/C4	96-97	
		VN1500D1/D2	96-97	
DRR-416	REAR	ZR1100G1-C4 ZRX1100	97-00	
		ZR1100D1-D4 ZRX1100	97-00	
		ZR1200 ZRX1200	01	
		ZX1200C1/C2 ZZR1200	02-03	
DRR-417	REAR	ZX1100E1/E2/E3 GPZ1100	95-97	
DRR-418	REAR	KX85 A1-A8	01-08	
		KX100 D1-D8	01-08	
DRR-419	REAR	KDX200 H1-H8	95-02	
		KDX220 A4-A9	97-02	
		KLX300A2-A7	97-02	
DRR-420	REAR	KL650A	87-07	
		KL650B2-B3	90-91	
DRR-421	REAR	ZXR250/250SP	89	
		GPZ500S(EX500)	94-00	
		EX500E1-E9	94-02	
		EX500D1-D9	94-02	
DRR-422	REAR	ZX600C1-C9 GPX600R	88-86	
		ZR1100A1/A2	02-93	
DRR-423	REAR	EX250F2-F14	88-00	
DRR-424	REAR	ZX1200A5	05	
Solid		ZZR1200C3-C4	04-05	
DRR-KS1	REAR	KX125M1-M3	03-05	
		KX250M1/M2	03-04	
		KX250R	05-07	
		KX250F	05-08	
		KX450F	06-08	
		RM-Z250K4/K5/K6	04-06	

SUZUKI

DRF-301	FRONT	RGV250	88-90	*
floating		GSX-R400	89	*
		GSF600S BANDIT	96-03	
		GSF600 BANDIT <GN77B>	95-	*
		GSX600F (K-V) <GN72B>	89-97 *	
		GSX600F	98-00	
		RF600R (R-T) <GN76B>	94-96	
		GSX750F(K-V) <GR78A>	89-97 *	
		GSX750F	98-00 *	
		SV650	99-00	
DRF-303	FRONT	GSX-R750 (J-M) <GR77B>	88-91	*
floating		GSX-R750 <GR7AB>	90-91 *	
		GSX-R750 (N)	92 *	
		GSX-R750W (P-S) <GR7BB>	93-95	
		GSXR1100 (K-N) <GV73C>	89-92 *	
		GSX-R1100W (P-V) <GV75C>	93-97 *	
DRF-306	FRONT	GSF250N/ZM/P/NP/ZP		
		GSF400 <GK75B>	91	
		GS500E(K-W) <GM51B>	89-98	
		GS500E	99-02	
		GSX600F	01-02 *	
		GSX750F	98-02	
		SV650	99-02	
		RF900R <GT73B>	94	
		RF900R(S-V)	95-97 *	
		GSF1200 T/V/W/X/Y	96-00	
		GSX1200S T/V/W/X	96-99	
		GSF1200 ABS <GV75A>	96	
		GSX1200X	99	
DRF-307	FRONT	GSX-R600	97-03	
floating		GSX-R750	96-03	
		TL1000S	97-00	
		TL1000R	98-03	
		GSX1300R FALCON	99	
		GSX1300R HAYABUSA	99	
		GSX1300R	99-02	
DRF-308	FRONT	RG125U WOLF	82-84	
floating		RG125FU GAMMA	82-86	
		RGV250	91-95	
		GSX400R(GK78A)	90-95	
		VZ800 MARAUDER	97-	
DRF-309	FRONT	SV650S K2-K6	03-06	
floating		GSX600F K3-K6	03-06	
		GSX750F K3-K6	03-06	

STOCK NO.		MODEL		ABE
DRF-310	FRONT	DL1000 K2-K4	02-04	
floating		V-STORM		
DRF-311	FRONT	GSX-R1000K3-K4	03-04	
floating				
DRF-RM1	FRONT	RM125	89-03	
solid		RM250	89-03	
		RMX250(K-W)	89-98	
		DR350V	97-00	
DRF-RM3	FRONT	RM125	04-08	
		RM250	04-08	
DRF-RM4	FRONT	RM-Z250K7-K8	07-08	
		RM-Z450K5-K9	05-08	
DRF-312	FRONT	DR-Z400S	00-05	
Solid				
DRF-313	FRONT	DR-Z250	01-05	
Solid		DR-Z400E	00-05	
		DR-Z400	00-05	
DRF-314	FRONT	DR-Z400SM MOTARD	05	
floating		DR-Z450SM MOTARD	05	
DRF-315	FRONT	VL1500	98-01	
Solid				
DRF-316R	FRONT	VL1500	02-05	
Solid	right			
DRF-316L	FRONT			
Solid	Left			
DRR-301	REAR	GSX1100F <GV72C>	88-93	*
solid				
DRR-302	REAR	GSF400M/P/R/S/T	91-96	
solid		GSF400 BANDIT <GK75B>	91	*
		GS500E <GM51B>	89-98	
		GS500E	99-02	
		GSX600FJ	88	
		GSX600F <GN72B>	89-92	*
		GSX750F <GR78A>	89	*
		GSX750F (K-N)	89-92	
		GSX750F (P-V)	93-97	
DRR-303	REAR	GSX-R750 J/K/L/M/N/P	88-93	
Solid		GSX-R750 <GR77B>	88-92	*
		GSX-R750 <GR7AB>	90-91	*
		GSX-R750W <GR7BB>	92-95	*
		GSX-R1100 K/L/M/N<GV73C>	89-92	*
		GSX-R1100W P/R	93-94	
DRR-304	REAR	GSF600 BANDIT<GN77B>	95	*
Solid		GSF600S	96-03	
		GSX600F	98-06	
		RF600R <GN76B>	93	*
		RF600R R/S/T	94-96	
		SV650	99-02	
		SV650S	99-02	
		GSX750 W/X/Y	98-00	
		GSX750F	98-06	
		RF900 R/S/T/V	94-97	
		RF900R <GT73B>	94	*
		GSX-R1100W S-W	95-98	
		GSX1200X	99-01	
		GSF1200 BANDIT	96-05	
		GSX1300R	99-03	
DRR-305	REAR	GSX-R600	97-03	
solid		GSX-R750	96-03	
		TL1000S	97-00	
		TL1000R	98-03	
		GSX1300R FACLON	99	
DRR-306	REAR	DL1000K2-K6	02-06	
solid		V-STORM		
HONDA				
DRF-101	FRONT	GB500 <PC16>	86-91	*
solid		XBR500 <PC15>	85-91	*
		CBR600F <PC19>	87-91	*
		CBR600F <PC23>	88-91	*
		CBR600F <PC25>	91-94	*
		XL600V TRANSALP <PD06>	87-93	*
		CBX650E <RC13>	82-90	*
		CB700SC	84-86	
		VF700F	85	
		VF700S	84-85	
		VF750S <RC07>	82-87	*
		VFR750F <RC24>	86-91	*
		CBX750F <RC17>	83-88	*
		CBX750FE	84	
		XLV750R <RD01>	83-87	*
		PC800 PACIFIC COAST	97	
		VF1000F <SC15>	84-86	*
		VF1000R <SC16>	84-86	*
		VF1100S SABRE	84-85	
DRF-102	FRONT	CB500 <PC26>	93-95	*
solid		CB500 <PC32>	95	*
		CB500	96-97	*
		XRV650 AFRICA TWIN <RD03>	88-90	*
		CB750 SEVEN FIFTY <RC42>	92	*
		CB750F2	92-99	
		VFR750F <RC24>	88-91	*
		VFR750F <RC36>	90-93	*
		CBR1000F <SC21>	87-91	*
		CBR1000F <SC24>	89-92	*
		CBR1000F	93-95	
		ST1100A	99-02	
DRF-103	FRONT	NTV650 REVEREE <RC33>	88-92	*
solid		VF750C <RC43>	93-96	*
		CB750 NIGHTHAWK	91-00	
		ST1100	90-02	
		ST1100 <SC21>	92	*
		ST1100A ABS	92-95	
DRF-CR1	FRONT	CR125R	95-07	
solid		CR250R	95-07	
		CR500R	95-01	

STOCK NO.		MODEL		ABE
DRF-CR1	FRONT	CRF250R	04-08	
		CRF250X	04-08	
		CRF450R	02-08	
		CRF450X	04-08	
DRF-104	FRONT	CBR600F	99-00	
		CBR600F4 X/Y	99-00	
		VFR800FI	98-00	
		CBR900RR	92-93	
		XL1000V X/Y	99-01	
DRF-105	FRONT	VTR1000F FIRESTORM	97-00	
FLOATING		CBR900RR FIREBLADE	95-97	
		VFR750F	94-97	
		CBR600F	95-98	
		CBR400RR J/K <NC23>		
		CBR400RR <NC29>		
		RVF400RR/RT<NC35		
		VFR400R3K/R3L/R3N<NC30>		
DRF-106	FRONT	CBR600F	01-06	
FLOATING		CBR600FS	01-02	
		CB900F	02-07	
		VTX1800R	02-04	
		VTX1800S	02-03	
		VTX1800C/C1/C2/C3		
		VTX1800N	04-05	
		VTX1800T	07	
DRR-101	REAR	CBR400RR <NC29>	90-94	
Solid		CBR250	90-94	
		CB600F HORNET	98-01	
		CBR600F	91-03	
		CBR600F4	98-02	
		CBR600FS	01-02	
		CBR600FR	02	
		CBR900RR	92-02	
		CBR900RE	01	
		VTR1000F FIRESTORM	97-00	
		VTR1000SP	00-01	
DRR-102	REAR	CBR1100SF	00-01	
Solid		CBR1100XX	97-06	
		CBR1000F	93-99	
		VFR750F	86-89	
YAMAHA				
DRF-201	FRONT	TZR250	88	
floating		TZR250<2MA>	89-90	*
		SZR660	95	
		SZR660<4SU>	96	*
		FZR750R	87-88	
		YZF750R<4HN>	93	*
		YZF750SP<4HT>	93	*
		YZF750R/SP <4FM>	93	*
		YZF750R/SP <4HD>	93	*
		YZF750R/SP <4HS>	93	*
		FZR1000 EXUP<3LE>	89-91	*
		FZR1000 EXUP<3LK>	89-91	*
		FZR1000 EXUP<3LG>	89-91	*
		FZR1000 EXUP<3GM>	89-91	*
		FZR1000 EXUP	92-93	
		XJR1200<4PU>	95-96	*
DRF-203	FRONT	YZF600R THUNDERCAT	96-02	
floating		YZF-R6	99-02	
		XJ600S/N DIVERSION	98-99	
		YZF1000R THUNDERACE	96-01	
		YZF-R1	98-00	
		XJR1300	99-01	
DRF-204	FRONT	XV535/S VIRAGO	95-00	
solid		XVS650	97-01	
		XVS650A	98-02	
		XVS1100	99-00	
		XVZ13AH/ATH	96	
		XV13LTJ	97	
		XV13TF	00	
		XV1300A	00	
		XV1600A	99-00	
DRF-205	FRONT	FZR400RR	90	
		FZR600	89-93	
		FZR600R	94-95	
		FZS600	98-02	
		FZS600S	01-02	
		FZS600N	01-02	
		FZ750	89-91	
		TDM850	91-99	
		TRX850	96-98	
		FJ1200	88-95	
DRFR-202	F & R	RD350 YPVS	83-84	
solid		RD350	85	
		RD350 <31K>	85-88	*
		RD350 <1WW>	86-90	*
		RD350 <1WX>	86-90	*
		FJ600	87-88	
		XJ600 <51J>	84-93	*
		FZ750	87-88	
		FZ750 <1FN>	85-88	*
		FZ750 <2KIC>	85-91	*
		XS400 <1ZE>	82-91	*
		FZX750 FAZER <2JE>	87-90	*
		XV750	88-94	
		XV750 VIRAGO <4FY>	92	*
		XV750 VIRAGO <4PW>	94	*
		XV750 <41Y>	83-96	*
		XJ900 <31A>	83-86	*
		XV1100 VIRAGO	89-93	
		XV1100 VIRAGO <2AE>	88-94	*
		XV1100 VIRAGO <3LP>	89	*
		XJ900S	95-98	
		XJ900 DIVERSION <4KM>	94	*
		FZR1000	87-95	

STOCK NO.		MODEL		ABE
DRFR-202		FZR1000 EXUP <3LE>	92-93	*
		FZR1000 EXUP <3LK>	92-93	*
		FZR1000 EXUP <3LG>	92-93	*
		FZR1000 EXUP <3GM>	92-93	*
		XJR1200	95	
		XJR1300	99	
DRR-201 solid	REAR	FZR600	89-93	
		FZR600 <3RG>	89	*
		FZR600 <3HE>	89	*
		FZR600 <3RH>	89	*
		YZF600R THUNDERCAT	96-02	
		YZF600R <4TV>	96	*
		XJ600S/SN	92-93	
		XJ600S/N	94-99	
		XJ600S/N DIVERSION<4BRB>	91-94	*
		FZS600	98-02	
		YZF750 R/SP	93	
		TDM850	91-99	
		TDM850 <3VD>	91	*
		TDM850 <4TX>	96	*
		TRX850 <4UN>	96	
		YZF1000R THUNDERACE	96-01	
		YZF- R1	98-00	
		YZF-R1 <RN01>	98	*

DUCATI

DRF-201 floating	FRONT	600 MONSTER<M>	94-	*
		600 SS<S>	94-	*
		748<748>	95-	*
		750 MONSTER<M>	95-	*
		750 SS<S>	91-94	*
		750 SS<S>	95-97	*
		888<888>	94-	*
		851<851>	91-	*
		900 MONSTER<M>	94-	*
		900 SS/SL<S>	94-	*
		916/916 SP<916>	94-	*
		ST 2<S1>	98-	*
DRR-201	REAR	600 SS	94-	
		M600 MONSTER	94-97	
		750 SS	92-	
		750 MONSTER	96-	
		900 SS/SL	92-	
		900 SS SUPERSPORT	89	
DRF-205	FRONT	900 SUPERSPORT	89	

LAVERDA

DRF-201	FRONT	650 FORMULA/GHOST<ZLV650SP>	96-	*
		650 FORMULA/GHOST<ZLVSPA>	96-	*
		650 LEGEND/STRIKE<ZLV650SP>	96-	*
DRR-201	REAR	650 ALL	95-	

MOTO GUZZI

DRF-201	FRONT	1100 SPORT<KE>	96-	*
		CENTAURO V10 <KIK>	96-	*
		DAYTONA<KL>	96-	*
		CALIFORNIA EV <KD>	96	*

APRILIA

DRF-201	FRONT	RS125 EXTREMA<GS>	94-	*
		RSV MILLE	99	
DRF-205	FRONT	RS250	98-	

BIMOTA

DRF-201	FRONT	SUPERMONO<BB1>	96	*
		MANTRA<DB1>	96-	*
		SB6<SB6>	96-	*

CAGIVA

DRF-201	FRONT	MITO 125<8P>	92-95	*
		SUPERCITY<2F>	93-97	*
DRF-205	FRONT	RAPTOR/VRAPTOR	00-	

STOCK NO.	MODEL	ABE
-----------	-------	-----

DRF-302 IS NO LONGER AVAILABLE

MASTERCYLINDER REPAIR KIT

* Check O.E.Ref. and make sure that you are ordering correct item.



MODEL	YEAR	FRONT	REAR
	HONDA		
NSR50S	89/93-95	MSB-101	
NSR50R	97-00	MSB-108	
CR80R	87-91	MSB-122	
CR80R	92-97	MSB-122	MSR-103
CR80R	98-99	MSB-111	MSR-103
CR80R	00-02	MSB-121	MSR-103
CR80RB	98-99	MSB-111	MSR-103
CR80RB	00-02	MSB-121	MSR-103
CR85R	03-07	MSB-121	MSR-103
CR85RB	03-07	MSB-121	MSR-103
ANF125	03/05-06	MSB-101	
ANF125T	05-06	MSB-101	
CA125	95-96	MSB-101	
CA125S	95-96	MSB-101	
CB125T	93	MSB-102	
CB125TD	88	MSB-102	
CBR125R	04-05	MSB-108	MSR-103
CBR125RS	05-06	MSB-108	MSR-103
CBR125RW	05-06	MSB-108	MSR-103
CG125ES	04	MSB-108	
CR125R	87-98	MSB-111	MSR-103
CR125R	99-01	MSB-121	MSR-103
CR125R	02-06	MSB-121	MSR-114
CRM125R	90-99	MSB-124	MSR-103
CLR125W	98	MSB-124	
FES125	98-02	MSB-108	MSB-102
FES125	03-05	MSB-101	MSB-102
NES125	00-06	MSB-101	
NSR125R	89-00/01		MSR-103
NSR125F	91-93		MSR-103
MTX125RW	87/90	MSB-113	
NX125	89/95/97	MSB-124	
SH125	01-06	MSB-101	
XL125L	03-06	MSB-123	
XL125V	01-06	MSB-108	MSR-103
XLR125R	98	MSB-101	
VT125C	99-06	MSB-108	
VT125C2	00-01	MSB-108	
FES150	98-02	MSB-108	MSB-102
FES150	03-05	MSB-101	MSB-102
NES150	01	MSB-101	
SH150	01-06	MSB-101	
CRF150R	08-09	MSB-121	MSR-119
CB250	94-04	MSB-108	
CB250P	96,04-05	MSB-108	
CBR250R/RK	MC19	MSB-108	
CD250U	88-89	MSB-101	
CMX250C/CD	85-87	MSB-101	
CMX250C	96-97	MSB-101	
CMX250C	02-09	MSB-101	
CN250	87-99	MSB-102	
CR250R	87-98	MSB-111	MSR-103
CR250R	99-01	MSB-121	MSR-103
CR250R	02-06	MSB-121	MSR-114
CRF250R	04-06	MSB-121	MSR-114
CRF250R	07-10	MSB-129	MSR-120
CRF250X	04-06	MSB-121	MSR-114
FES250	98-99	MSB-108	MSB-102
FES250	00-05	MSB-101	MSB-102
NX250	88-90/92-96	MSB-108	

MODEL	YEAR	FRONT	REAR
VTR250R	89-90	MSB-101	
XR250R	90/92		MSR-103
XR250R	96-98	MSB-113	
XR250R	99-02	MSB-123	MSR-105
XR250R	04	MSB-123	MSR-105
CB250N	79	MSB-106	
CB250NDc	82	MSB-102	
CB250RS	80	MSB-106	
CBX250RS	85-87	MSB-101	
CMX250C	85-87	MSB-101	
CMX250C	96-97	MSB-101	
CN250	96-97	MSB-102	
CB360/G/T	73-76	MSB-107	
CB-1	89-90	MSB-108	
CB400 SUPER 4/F2N/F2R	NC31	MSB-102	MSR-103
CB400 SUPER 4/F2S/F2T/F2V	NC31	MSB-102	MSR-103
CB400 SUPER 4/F3S/F3T	NC31	MSB-102	MSR-103
CB400 SUPER 4/F3V	NC31	MSB-103	MSR-103
CB400- CB1/FK/FK2/FL/FL 2	NC27	MSB-108	
CB400- CB1/FM/FM2	NC27	MSB-108	
CB400F	75-77	MSB-107	
CB400N	79	MSB-105	
CB400Nc	82	MSB-103	
CB400TII HAWK II	79	MSB-106	
CB400T HAWK	80	MSB-106	
CB400T	82	MSB-102	
CBR400RRJ/RRK	NC23	MSB-101	
CBR400RRL/RRN/R RR/RRR-3	NC29	MSB-101	
CM400C CUSTOM	81	MSB-102	
CM400A Z/A	79-80	MSB-106	
CM400T B/C	81	MSB-102	
VFR400ZG/RG/RG- YA	NC21	MSB-102	MSR-103
VFR400R3	90-91		
NS400R F	85	MSB-103	MSR-103
XR400R	96-98	MSB-113	MSR-103
XR400R	99-04	MSB-123	MSR-103
CB450 K4	77	MSB-107	
CB450S	88	MSB-102	
CB450SC	82-86	MSB-102	
CB450T HAWK	82	MSB-102	
CM450A/C	82-83	MSB-102	
CM450A/C/T	81	MSB-102	
CMX450C	86-88	MSB-101	
CRF450R	02-06	MSB-121	MSR-114
CRF450R	07-09	MSB-129	MSR-120
CRF450X	05-06	MSB-121	MSR-114
CB500	94-96	MSB-108	
CB500	97-00		MSR-103
CB500	02		MSR-103
CBF500	04/06	MSB-108	MSR-105
CBF500A	04-06	MSB-101	MSR-105
CB500S	98-00/02		MSR-103
CBR500F	87/89/91	MSB-102	
CR500R	90-97	MSB-111	MSR-103
CR500R	98-01	MSB-121	MSR-103
CX500	79	MSB-106	
CX500(B)	81	MSB-103	
CX500C CUSTOM	79	MSB-106	
CX500C(A)	80		
CX500C(B)	81	MSB-103	

MODEL	YEAR	FRONT	REAR
CX500C(B)			
CANADA,USA	81	MSB-102	
CX500C(C)	82	MSB-103	
CX500C(C)			
CANADA,USA	82	MSB-102	
CX500D DELUXE	79-80	MSB-106	
CX500D DELUXE	81	MSB-102	
CX500TC	82	MSB-103	MSR-101
FT500 ASCOT	82-83	MSB-102	MSR-101
GB500	89-90	MSB-101	
GL500 SILVERWING	81-82	MSB-102	
GL500I INTERSTATE	81-82	MSB-103	
NX500N/P/R	92-94	MSB-108	MSR-103
VF500FT ASCOT	83-84	MSB-102	
VF500C MAGNA	84-85	MSB-102	
VF500FE/F2E/FF			
INTERCEPTOR	84-85	MSB-103	MSR-103
VT500C	83-86	MSB-102	
VT500E(D)	83	MSB-101	
VT500FT ASCOT	83-84	MSB-102	
XBR500 F	85	MSB-101	
XBR500	87	MSB-101	
XBR500S	87-88	MSB-101	
CB550F	76	MSB-107	
CB550K	77	MSB-107	
CB550SC			
NIGHTHAWK	83	MSB-102	
CBX550FC/R2C	82	MSB-103	
CB600F	98-99	MSB-102	MSR-105
CB600F	00-06	MSB-101	MSR-105
CB600F	07-08	MSB-101	
CB600F2	00-02	MSB-101	MSR-105
CBF600N	04-06	MSB-101	MSR-105
CBF600N	07-08	MSB-101	
CBF600NA	04-06	MSB-101	MSR-105
CBF600S	04-06	MSB-101	MSR-105
CBF600S	07-08	MSB-101	
CBF600SA	04-06	MSB-101	
CBR600F	87-90	MSB-102	MSR-103
CBR600F	91-94	MSB-101	MSR-103
CBR600F	95-98	MSB-101	MSR-105
CBR600F	99-06	MSB-103	MSR-105
CBR600F2	91-92	MSB-101	
CBR600F3	95-98	MSB-101	
CBR600F4	99-04	MSB-103	MSR-105
CBR600FS	01-02	MSB-103	MSR-105
CBR600FR	01-02	MSB-103	MSR-105
CBR600RR	03-06	MSB-127	MSR-106
CBR600SE	98	MSB-101	
FJS600	01-02	MSB-108	MSB-101
FJS600A	03-05	MSB-108	MSB-101
FJS600D	03-05	MSB-108	MSB-101
NTV600	88-91	MSB-101	MSR-103
VT600C	88-92	MSB-115	
VT600C	93-99	MSB-108	
XL600V	91-93		MSR-105
XL600V	94-96	MSB-108	MSR-105
XL600V	97-99	MSB-101	MSR-105
XL600L	93-00		MSR-103
XR600R	85	MSB-111	
XR600R	91-92	MSB-112	MSR-103
XR600R	93-00	MSB-112	MSR-103
CB650Z	79	MSB-105	
CB650	81-82	MSB-102	
CB650C	80	MSB-106	
CB650C CUSTOM	81	MSB-103	
CB650SC	82-85	MSB-103	
CX650ED	83	MSB-103	
CX650C CUSTOM	83	MSB-102	
CX650E E	84	MSB-103	MSR-101
CX650T TURBO	83	MSB-103	MSR-101
GL650 SILVERWING	83	MSB-103	
GL650/I	83	MSB-103	
NT650 HAWK GT	88-91	MSB-101	
NT650V W/X/Y	98-00		MSR-105

MODEL	YEAR	FRONT	REAR
NT650V	02	MSB-125	
NT650V	03-05	MSB-125	MSR-116
NTV650	88-92	MSB-101	MSR-103
NTV650	93-97	MSB-108	MSR-103
NX650	88-96	MSB-108	MSR-103
NX650	97-99		MSR-103
SLR650 V	97		MSR-103
XL650V	01-03	MSB-101	MSR-105
XL650V	04-06	MSB-101	MSR-105
XRV650	88-89	MSB-108	MSR-105
XR650L	01-04		MSR-103
XR650R	00-06	MSB-123	MSR-103
CB700SC			
NIGHTHAWK	84-86	MSB-103	
VF700C MAGNA	84-86	MSB-103	
VF700C MAGNA	87	MSB-101	
VF700S SABRE	84-85	MSB-103	
VFR700F/F2			
INTERCEPTOR	86-87	MSB-103	MSR-103
VT700C SHADOW	84-85	MSB-103	
VT700C SHADOW	86-87	MSB-102	
CB750K1-K2	70-72	MSB-107	
CB750K3-K6	73-76	MSB-107	
CB750L(Z)	79	MSB-106	
CB750F	75-76	MSB-107	
CB750A		MSB-107	
CB750C	80	MSB-106	
CB750C	81-82	MSB-103	
CB750K Z	79	MSB-106	
CB750K A	80	MSB-106	
CB750K	81-82	MSB-102	
CB750F Z	79	MSB-105	MSR-102
CB750F A	80	MSB-105	MSR-102
CB750F B	81	MSB-103	MSR-101
CB750F C/2C	82	MSB-103	MSR-101
CB750F2	92-01	MSB-101	MSR-103
CB750 NIGHTHAWK	91-97	MSB-108	
CB750M/N	91	MSB-101	
CB750SC	82-83	MSB-103	
CBX750F	84-86	MSB-103	
CBX750F2 G	86	MSB-103	
CBX750P2	87/90	MSB-103	
CBX750P2	94-98,01	MSB-103	
NR750	92	MSB-102	
RVF750R	94-95		MSR-105
VF750C	82-86	MSB-103	
VF750C	93-00	MSB-108	
VF750CD	95-96	MSB-108	
VF750F	83-85	MSB-103	
VF750S C/D	82-83	MSB-103	
VFR750F G	86	MSB-103	MSR-103
VFR750F H	87	MSB-103	MSR-103
VFR750F	88-97	MSB-101	MSR-103
VFR750R	88-90	MSB-119	MSR-105
VT750C	83-85	MSB-103	
VT750C	97-01	MSB-108	
VT750C	04-09	MSB-108	
VT750CA	06-09	MSB-108	
VT750C2	97-01	MSB-108	
VT750C2	09	MSB-108	
VT750DC	01-02	MSB-108	
XRV750	90-00	MSB-101	MSR-105
PC800 PACIFIC	89-98	MSB-102	
COAST			
VFR800F1	98-00	MSB-116(1ST)	MSR-115
		MSB-117(2ND)	
VFR800F1	01	MSB-116(1ST)	MSR-115
		MSB-117(2ND)	
VFR800	02-06	MSB-102	
		MSB-117(2ND)	
VFR800A	02-06	MSB-102	
		MSB-117(2ND)	
VT800C	88	MSB-101	
CB900C	80	MSB-105	MSR-102

MODEL	YEAR	FRONT	REAR
CB900C	81	MSB-105	MSR-101
CB900C	82	MSB-103	MSR-101
CB900CA	80	MSB-105	MSR-102
CB900F Z/A	79-80	MSB-105	MSR-102
CB900F B/2B	81		MSR-101
CB900F C/2C	82	MSB-103	MSR-101
CB900F	02-03	MSB-102	MSR-103
CB900F	04-05	MSB-102	MSR-103
CBR900RR	92-97		MSR-106
CBR900RR	98-99	MSB-119	MSR-106
CBR900RR	00-01	MSB-126	MSR-106
CBR900RR	02-03	MSB-127	MSR-106
CBR900RE	01	MSB-126	MSR-106
CB1000F	93-96	MSB-102	MSR-105
CBR1000F	87-88	MSB-103	MSR-103
CBR1000F	91	MSB-103	MSR-103
CBR1000F	89-92	MSB-101	MSR-103
CBR1000F	93	MSB-114	MSR-107
CBR1000F	94-97	MSB-101	MSR-107
CBR1000F	99	MSB-101	MSR-107
CBR1000RR	04-05	MSB-128	MSR-106
CBR1000RR	06-07	MSB-128	MSR-105
CBR1000RR	08-09	MSB-128	
CBX	79-80	MSB-105	MSR-102
CBX B/C	81-82	MSB-103	MSR-101
CBX(USA)	79-82	MSB-103	MSR-101
CBX1000 PRO LINK	81	MSB-103	MSR-101
VF1000F(2F/2G)BOL'DOR	85-86	MSB-103	
VF1000F E/F/G	84-86	MSB-103	
VF1000R F/G	85-86	MSB-103	MSR-103
VTR1000F	97-02		MSR-105
VTR1000F	03		MSR-105
VTR1000F	05-06	MSB-102	MSR-105
VTR1000SP	00-01	MSB-126	MSR-105
VTR1000SP	02-04	MSB-127	MSR-105
VTR1000SP	05-06	MSB-127	
XL1000 X/Y/1	99-00	MSB-116(1ST) MSB-117(2ND)	MSR-117
XL1000V	01-06	MSB-116(1ST) MSB-117(2ND)	MSR-117
XL1000VA	04-06	MSB-116(1ST) MSB-117(2ND)	MSR-117
CB1100R B	81	MSB-103	MSR-101
CB1100R	82-83	MSB-103	
CB1100SF	00	MSB-116(1ST) MSB-120(2ND)	MSR-108
CB1100SF	01	MSB-116(1ST)	
CBR1100XX	97-98	MSB-116(1ST) MSB-120(2ND)	MSR-107
CBR1100XX	99-06	MSB-116(1ST) MSB-120(2ND)	MSR-108
GL1100 GOLDWING	80-81		
GL1100C/IC/DC/AC	82	MSB-103	
GL1100D/ID/DD/D2 D/AD	83	MSB-102	
ST1100	90-00	MSB-102	MSR-103
ST1100A	92-95	MSB-102	MSR-103
ST1100A	96-02	MSB-116(1ST) MSB-120(2ND)	MSR-107
VF1100C	83-86	MSB-103	MSR-101
VF1100S	84-85	MSB-103	
VT1100C	85-86	MSB-103	
VT1100C	87-96	MSB-115	
VT1100C	97-98	MSB-101	
VT1100C2	95-00	MSB-101	
VT1100C2	01-05	MSB-101	MSR-103
VT1100C3	98-02	MSB-101	
GL1200	84	MSB-102	
GL1200(E)	84	MSB-101	
GL1200A(E)	84	MSB-101	
GL1200A USA	85-87	MSB-101	
GL1200D(E) <MKT C,M,E,EL>	84	MSB-101	
GL1200D(E) MKT G	84	MSB-103	

MODEL	YEAR	FRONT	REAR
GL1200I USA	85-87	MSB-101	
CB1300	05	MSB-102	MSR-105
CB1300A	05	MSB-102	MSR-105
CB1300F1	03	MSB-102	MSR-105
CB1300F	03	MSB-102	MSR-105
CB1300S	05	MSB-102	MSR-105
CB1300SA	05	MSB-102	MSR-105
ST1300	02-06	MSB-116(1ST) -	MSR-118
ST1300A	02-06	MSB-116(1ST) -	MSR-118
VTX1300S	03-04	MSB-101	MSR-103
VTX1300S	05-06	MSB-108	MSR-103
VTX1300C	04	MSB-108	MSR-103
VTX1300C	06-09	MSB-108	
VTX1300R	09	MSB-108	
GL1500	88-90	MSB-114	MSR-106
GL1500A	91-92	MSB-114	MSR-106
GL1500A	93-94	MSB-114	MSR-106
GL1500A	96-00	MSB-114	MSR-106
GL1500C	97-98,00-03	MSB-102	
GL1500CD	01-03	MSB-102	
GL1500CT	97-00	MSB-102	
GL1500SE	91-92	MSB-114	MSR-106
GL1500SE	93-94	MSB-114	MSR-106
GL1500SE	96-00	MSB-114	MSR-106
GL1500CF	99-00	MSB-102	
GL1800A	01-04	- MSB-120(2ND)	
VTX1800C	02-04	MSB-102	MSR-108
VTX1800C1	05		MSR-108
		KAWASAKI	
KX65	00-06		MSR-404
KX80N	88-90	MSB-408	MSR-404
KX80L	88	MSB-408	MSR-404
KX80L	89-90	MSB-408	MSR-404
KX80R	91-93	MSB-408	MSR-404
KX80R	94-96	MSB-409	MSR-404
KX80R	97		MSR-404
KX80T	91-94	MSB-408	MSR-404
KX80W	98-00	MSB-413	MSR-404
KX85	01-08	MSB-412	MSR-404
KX100	96-97	MSB-409	MSR-404
KX100D1-D3	01-03	MSB-412	
BN125	98	MSB-402	
KX125	84-85		MSR-404
KX125	86		MSR-404
KX125	87-90	MSB-408	MSR-404
KX125	91-92	MSB-408	MSR-403
KX125	93	MSB-410	MSR-403
KX125	94-96	MSB-409	MSR-404
KX125	97-99	MSB-411	MSR-404
KX125	00		MSR-404
KX125	01	MSB-412	MSR-404
KX125	02	MSB-412	MSR-404
KX125	03-04	MSB-412	MSR-404
KX125	05	MSB-412	MSR-404
KX125M6F	06	MSB-412	MSR-404
KMX125	86-87		MSR-404
KDX200 E1-E4	89-92	MSB-408	MSR-404
KDX200 E5-E6	93-94	MSB-408	MSR-404
KDX200 H1-H6	95-00	MSB-409	MSR-404
KDX220 A4-A7	97-00	MSB-409	MSR-404
EL250B2/B3	88-89	MSB-402	
EL250D4/D5	93-94	MSB-402	
EL250E1-E4	91-93	MSB-402	
EL250E4	94	MSB-402	
EX250E1/E2	86-87	MSB-402	

MODEL	YEAR	FRONT	REAR
EX250F2-F11 NINJA	88-97	MSB-402	
EX250F12-F14 NINJA	98-00	MSB-402	
EX250H3/H5	92/94	MSB-402	
EX250H12-H13	01-02	MSB-402	
KH250B1		MSB-404	
KDX250	91-94	MSB-408	
KLX250R D1-D4	93-96	MSB-409	MSR-403
KR250(KR1)	89	MSB-403	MSR-404
KX250	86		MSR-404
KX250	87-90	MSB-408	MSR-404
KX250	91-92	MSB-408	MSR-403
KX250	93	MSB-410	MSR-403
KX250	94-96	MSB-409	MSR-404
KX250	97-99	MSB-411	MSR-404
KX250	00		MSR-404
KX250	01-05	MSB-412	MSR-404
KX250R6F	06	MSB-412	MSR-404
KX250F	04-05	MSB-412	MSR-404
KX250F	06-10	MSB-412	MSR-404
KLX300R	97-00	MSB-409	MSR-404
KLX300R	05		MSR-404
S2 S2A 350	72-73	MSB-404	
KH400A3/A4	76-77	MSB-404	
KZ400/D/D3/D4	74-77	MSB-404	
KZ400A1/A2	77-78	MSB-404	
S3 S3A 400	74-75	MSB-404	
ZX400D1/D2 <GPZ400R>	85-86	MSB-403	
ZX400G1	88	MSB-403	
ZX400H1	89	MSB-401	
ZX400H2	90	MSB-401	
ZX400K1/K2/K3	90-92	MSB-401	
ZX400L1/L2/L3/L4	91-94	MSB-403	
KX450F	06-10	MSB-412	MSR-404
EN500A1-A7 VULCAN	90-96	MSB-402	
EN500C1-C8	96-03	MSB-402	
ER500A1-A3 ER-5	97-99	MSB-402	
ER500C	01-09	MSB-402	
EX500A1-A7	87-93	MSB-402	
EX500B1-B4 GPZ500S	88-91	MSB-403	
EX500D1-D7	94-00	MSB-403	
EX500D	01-09	MSB-403	MSR-404
EX500E9	02	MSB-403	MSR-404
H1B 500	72	MSB-404	
H1D H1E H1F 500	73-75	MSB-404	
KH500 A8	76	MSB-404	
KLE500	91-97	MSB-403	MSR-404
KLE500B1	05	MSB-403	MSR-404
KLE500B6F	06	MSB-403	MSR-404
Z500B1-B3	79-81	MSB-405	
KX500	86-88		MSR-404
KX500	89-90	MSB-408	MSR-404
KX500	91-93	MSB-408	MSR-403
KX500	94-96	MSB-409	MSR-404
KX500	97-00	MSB-413	MSR-404
KX500	01/03	MSB-413	MSR-404
KZ550D1	81	MSB-405	
KZ550H1/H2	82-83	MSB-407	MSR-401
Z550C1/C2	80-81	MSB-405	
ZR550B1	90	MSB-401	
ZR550B2/B3	91-92	MSB-401	
ZR550B4	93	MSB-401	
ZR550B5	94	MSB-401	
ZX550A1-A3	84-86	MSB-407	
ZL600A1/A2	86-87	MSB-402	

MODEL	YEAR	FRONT	REAR
ZL600B2/B3	96-97	MSB-402	
ZX600A1/A2/A3 GPZ600R	85-87	MSB-401	
ZX600B1	87	MSB-401	
ZX600C1-C10	88-97	MSB-401	
ZX600D1-D3	90-93	MSB-401	
ZX600E1-E13	93-05	MSB-401	MSR-404
ZX600E6F	06	MSB-401	MSR-404
ZX600F1-F3	95-97	MSB-401	
ZX600G1/G2	98-99	MSB-401	MSR-404
ZX600J1-J3	00-02	MSB-401	
ZX600J	05-08	MSB-401	
ZX600K1	03	MSB-403	
ZX600N1	05		MSR-404
ZX600P	07-08		MSR-404
ZX600R	09-10		MSR-404
ZX636A1	02	MSB-401	
ZX636B1-B2	03-04	MSB-403	
ZX636C1 ZX6R	05		MSR-404
ZX636C6F	06		MSR-404
EJ650A1/A2	99-00	MSB-402	
EJ650A3/A4	01-92	MSB-402	
EJ650C6-C7	04-05	MSB-402	
EJ650C6F	06	MSB-402	
ER650A	06-08	MSB-401	MSR-404
ER650B6	06	MSB-402	MSR-404
EX650A	06-08	MSB-401	
KL650A1-A9	87-95	MSB-402	
KL650A10-A14	96-00	MSB-402	
KL650B1 TENGAJ	89	MSB-403	
KL650B2-B3 TENGAJ	90-91	MSB-403	
KL650C7-C10	01-04	MSB-402	MSR-403
KLE650A	08	MSB-401	MSR-404
KLX60A1	93	MSB-410	
KLX650A2-A3	94-95	MSB-409	
KZ650B1	77	MSB-404	
Z650C2	78	MSB-405	
Z650C3	79	MSB-405	
KZ650C4	80	MSB-405	
Z650D2	79	MSB-405	
Z650F2/F3	81-82	MSB-405	
H2/H2A/H2B/H2C 750	72-75	MSB-404	
KZ750B1-B2	76-77	MSB-404	
KZ750F1	83	MSB-407	
KZ750H2-H4	81-83	MSB-405	MSR-401
KZ750L3	83	MSB-407	
KZ750R1	82	MSB-407	MSR-401
VN750A6-A14	90-98	MSB-401	
ZR750C1-C4 ZEPHYR	91-94	MSB-401	
ZR750F2-F3	00-01	MSB-401	MSR-403
ZR750F4-F5	02-03		MSR-403
ZR750H1/H3	01-03	MSB-401	MSR-403
ZR750J1-J2	04-05	MSB-401	
ZR750J6F	06	MSB-401	
ZR750K1H	05	MSB-401	
ZR750K6F	06	MSB-401	
ZX750F1-F4 GPX750R	87-90	MSB-401	
ZX750G2 GPZ750R	85	MSB-401	
ZX750H1/H2	90-91	MSB-401	
ZX750J1-J2 ZXR	91-92	MSB-401	
ZX750K1/K2 ZX7R	91-92	MSB-401	
ZX750L1-L3 ZXR750	93-95	MSB-401	
ZX750M1/M2	93-94	MSB-401	
ZX750N1/N2	96-97	MSB-401	MSR-403
ZX750P1-P3	96-00	MSB-401	MSR-403
VN800A1-A3	95	MSB-402	
VN800A4-A6	98	MSB-402	

MODEL	YEAR	FRONT	REAR
VN800B1-B7	96-02	MSB-402	
VN800B10	05	MSB-402	
VN800B6F	06	MSB-402	
VN800C1-C2	99-00	MSB-403	MSR-403
VN800E1/E2	01-02	MSB-403	MSR-403
VN900B	06-09	MSB-402	MSR-403
VN900C	09	MSB-402	MSR-403
VN900D	06-09	MSB-402	MSR-403
KZ900A4/A5	76-77	MSB-406	
Z1 Z1A/B 900	73-75	MSB-404	
ZL900A1/A2	85-86	MSB-401	
ZX900A1/A2			
GPZ900R	84-85	MSB-401	
ZX900B1-B2	94-95	MSB-401	
ZX900B3-B4	96-97	MSB-401	
ZX900C1-C2	98-99	MSB-401	MSR-404
ZX900E1-E2	00-01	MSB-401	MSR-404
ZX900F1 ZX-9R	02	MSB-401	MSR-404
ZX900F1P-F2P	02-03	MSB-401	MSR-404
ZX900F1H-F2H	02-03	MSB-401	
KZ1000A1	77	MSB-406	
KZ1000A3/A4	79-80	MSB-405	
KZ1000B1	77	MSB-406	
KZ1000B2 LTD	78	MSB-405	
KZ1000B3-B4 LTD	79-80	MSB-405	
KZ1000C1A POLICE	78	MSB-405	
KZ1000C2/C3/C4	79-81	MSB-405	
KZ1000E1/E2	79-80	MSB-405	
KZ1000G1	80	MSB-405	
KZ1000J1/J2	81-82	MSB-405	MSR-401
KZ1000J3	83	MSB-407	
KZ1000K1/K2 LTD	81-82	MSB-405	MSR-401
KZ1000M1/M2	81-82	MSB-405	MSR-401
KZ1000R1	82	MSB-407	MSR-401
KZ1000R2	83	MSB-407	
Z1000 MK2	79	MSB-405	
Z1000ST	79	MSB-405	
ZG1000A1-A8	86-93	MSB-401	
ZG1000A9-A12	94-97	MSB-401	
ZG1000A13-A14	98-99	MSB-401	
ZG1000A18	03	MSB-401	
ZL1000A1			
ELIMINATOR	87	MSB-401	
ZR1000A1-A3	03-06	MSB-401	MSR-404
ZR1000B	08		MSR-403
ZX1000A1/A2	85-86	MSB-401	
ZX1000B1-B3	88-90	MSB-401	
ZX1000C1-C2	04-05	MSB-403	MSR-403
ZX1000D	06-07		MSR-404
ZX1000E	08-09		MSR-404
KZ1100A1/A2	81-82	MSB-405	MSR-401
KZ1100A3	83	MSB-405	
KZ1100B1-B2	81-82	MSB-405	MSR-401
KZ1100D1	82	MSB-407	MSR-401
KZ1100L1	83	MSB-407	
ZR1100A1-A3	92-94	MSB-401	
ZR1100C1-C2	97-98	MSB-401	MSR-403
ZR1100C3	99	MSB-401	MSR-403
ZR1100D4	00	MSB-401	MSR-403
ZX1100C1-C4	90-93	MSB-401	
ZX1100D1-D8			
ZZR1100	93-00	MSB-401	MSR-403
ZX1100E1-E3 GPz	95-97	MSB-401	
ZX1100F1 GPZ	96	MSB-401	
ZX1100G1	88	MSB-401	
ZG1200A1	86	MSB-401	
ZG1200B1-B11	87-97	MSB-401	
ZG1200B12	98	MSB-401	
ZR1200A1-A5	01-05	MSB-401	MSR-403
ZR1200A6F	06	MSB-401	MSR-403
ZR1200B1-B3	01-03	MSB-401	MSR-403
ZR1200B4	04	MSB-401	MSR-403
ZR1200C1-C2	01-03	MSB-401	MSR-403
ZR1200C3	04	MSB-401	MSR-403
ZX1200A1/A2	00-02	MSB-401	MSR-403
ZX1200B1-B4	02-05	MSB-401	MSR-403
ZX1200B6F	06	MSB-401	MSR-403

MODEL	YEAR	FRONT	REAR
ZX1200C3/C4	04-05	MSB-401	MSR-403
ZN1300A5-A6			
VOYAGER	87-88	MSB-401	
ZX1400A	06-07		MSR-403
ZX1400B	06		MSR-403
ZX1400C	08-09		MSR-403
VN1500A1-A9	87-95	MSB-402	
VN1500A10-A12	96-98	MSB-402	MSR-403
VN1500B1-B4	87-90	MSB-402	
VN1500B6	92	MSB-402	
VN1500C1-C4	94-97	MSB-402	
VN1500D1/D2	96-97	MSB-402	
VN1500E1-E7	98-04	MSB-402	MSR-403
VN1500G1/G2	99-00	MSB-401	MSR-403
VN1500J1-J2	99-00	MSB-403	MSR-403
VN1500L1-L3	00-02	MSB-401	MSR-403
VN1500N1-N3	00-02	MSB-403	MSR-403
VN1500N	05-08	MSB-403	MSR-403
VN1500P1-P2	02-03	MSB-401	MSR-403
VN1500R1-R5	01-05	MSB-403	MSR-403
VN1600A1-A3	03-05	MSB-401	MSR-403
VN1600A6F	06	MSB-401	MSR-403
VN1600B1H-B2H	04-05	MSB-401	MSR-403
VN1600B6F	06	MSB-401	MSR-403
VN1600D1H	05	MSB-401	MSR-403
VN1600D	06-08	MSB-401	MSR-403
VN2000A1-A2	04-05	MSB-401	MSR-403
VN2000A6F	06	MSB-401	MSR-403
		SUZUKI	
RM80	90	MSB-305	MSR-302
RM80	91-01	MSB-305	MSR-303
RM85	02-04	MSB-305	MSR-303
RM85	05		MSR-303
GN125(U/E)V/W	97-98	MSB-307	
GZ125(U)W/X	98-99	MSB-307	
RM125	89-91	MSB-305	MSR-302
RM125	92	MSB-305	MSR-303
RM125	93-95	MSB-305	
RM125	96-03	MSB-306	MSR-303
RM125	04		MSR-303
RM125	05-06		MSR-303
TU125XT X	99	MSB-307	
VL125(U)Y	00	MSB-307	
DR250L/M/N/P	90-93	MSB-305	MSR-303
DR250S L-N	90-92		MSR-303
DR250SE P-S	93-95		MSR-303
DR-Z250	01-04	MSB-305	
GN250J	88-98	MSB-303	
GS250TT/TX	80-81		
GSX250F M-R	91-94	MSB-304	MSR-303
GZ250	99-00	MSB-307	
RGV250 L/M/N/P/R	VJ22A	MSB-302	
RM250	89-95	MSB-305	
RM250	96-03	MSB-306	MSR-303
RM250	04		MSR-303
RM250	05-06		MSR-303
RMX250	89-98	MSB-305	
RM-Z250	04		MSR-404
RM-Z250	05-06		MSR-404
RM-Z250	07-09	MSB-308	MSR-306
TU250X W	98	MSB-304	
DR350 L-W	90-98	MSB-305	MSR-303
DR350S	90-93		MSR-303
DR350SE	94-98		MSR-303
AN400	03-06		MSB-303
AN400	07-09	MSB-307	MSB-307
AN400 ABS	08-09	MSB-307	MSB-307
DR-Z400	00-04	MSB-306	MSR-303
DR-Z400E	00-04	MSB-306	MSR-303
DR-Z400S	00-09	MSB-309	MSR-303
GN400TZ	82	MSB-303	

MODEL	YEAR	FRONT	REAR
GSF400M/N/P BANDIT	91-93	MSB-304	
GSX400X H	87	MSB-303	MSR-302
GSX-R400/C/-2	GK71B	MSB-303	
GSX-R400-3/SH	GK71F	MSB-303	
GSX-R400RJ/RK	GK73A	MSB-302	
GSX-R400RL/LM/RN/RP/RS	GK76A	MSB-302	
GS450GA F	85	MSB-303	
GS450LD	83	MSB-303	
GS450L F/G/H/J	85-88	MSB-303	
RM-Z450	07-09	MSB-308	MSR-306
GS500E K-T	89-96	MSB-304	MSR-303
GS500E	97-02	MSB-307	MSR-303
RG500	86	MSB-303	
GS550E C/N/T	78-80		MSR-301
GS550L N/T	79-80		MSR-301
GS550LX	81		MSR-301
GS550L D-G	83-86	MSB-304	
GS550M Z	82		MSR-301
GS550T X	81		MSR-301
GSX550E(F/G)	85-86	MSB-301	
GSX550EF(F/G)	85-86	MSB-301	
GSX550ES(F/G)	85-86	MSB-301	
GSX550EU(G)	86	MSB-301	
DR600	90	MSB-303	
DR600SE T/V	96-97	MSB-304	
DR600S L/M/N/P	90-93	MSB-303	
DR600SE R/S	94-95	MSB-303	
GSF600(U/SU)	95-96	MSB-303	MSR-303
GSF600S BANDIT	96-99	MSB-303	MSR-303
GSF600S	00-03	MSB-302	MSR-303
GSR600	06-09	MSB-302	MSR-305
GSX600F J	88	MSB-303	MSR-303
GSX600F K-V	89-97	MSB-302	MSR-303
GSX600F W/X	98-99	MSB-303	MSR-303
GSX600F	00-02	MSB-303	MSR-303
GSX-R600 W N/P	92-93	MSB-302	MSR-303
GSX-R600 V/W/X/Y	97-00	MSB-303	MSR-303
GSX-R600	01-02	MSB-302	MSR-303
GSX-R600	03	MSB-302	
GSX-R600	04-07		MSR-305
GSX-R600	08-09		MSR-305
RF600R P-V	93-97	MSB-304	MSR-303
VS600GL S-V	95-97	MSB-304	
AN650	03-09	MSB-307	MSB-307
DL650	04-06	MSB-302	MSR-305
DL650	07-09	MSB-303	MSR-305
DR650RSE M-T	91-96	MSB-303	
DR650RE(R/UR)	94	MSB-303	
DR650S N	92	MSB-303	
DR650SE			
T/V/W/X/Y	96-00	MSB-307	MSR-303
DR650SE K1-K4	01-04	MSB-307	
GS650E X/Z	81-82		MSR-301
GS650GL D	83	MSB-303	
GSF650	07-08	MSB-303	MSR-305
GSX650F	08-09	MSB-303	MSR-305
LS650P T-K3	96-03	MSB-307	
LS650	04-09	MSB-307	
SV650(U/S/SU)X/Y	99-00	MSB-302	MSR-303
SV650/S	01-02	MSB-302	MSR-303
SV650	03-09	MSB-302	MSR-305
SV650S	08-09	MSB-302	MSR-305
SFV650	09	MSB-303	MSR-305
XF650(U)V/W	97-98	MSB-307	
GS700E F	85	MSB-301	
GS700ES F	85	MSB-302	
GV700GLF/GLF2 MADURA	85	MSB-302	

MODEL	YEAR	FRONT	REAR
VS700GLEFG/GLEF H INTRUDER	86-87	MSB-303	
VS700GLEPG/GLEP H INTRUDER	86-87	MSB-303	
VS700GLFG/GLFH INTRUDER	86-87	MSB-303	
VS700GLPG/GLPH INTRUDER	86-87	MSB-303	
GS750 B/C/N	77-79		MSR-301
GS750E C/N	78-79		MSR-301
GS750E D	83	MSB-301	
GS750L T/X	80-81		MSR-301
GS750S D	83		MSR-301
DR750S J	88	MSB-303	
GSX750 T/X	80-81	MSB-301	MSR-301
GSX750E T/X/Z	80-82	MSB-301	MSR-301
GSX750E E	84	MSB-301	
GSX750EF E	84	MSB-302	
GSX750ES D	83	MSB-302	
GSX750ES E	84	MSB-302	
GSX750F K/L/M/N	89-92	MSB-303	MSR-303
GSX750F P/R/S/T	93-96	MSB-303	MSR-303
GSX750F	97-03	MSB-303	MSR-303
GSX750L T/X	80-81		MSR-301
GSX750RX G	85	MSB-302	
GSX-R750 F-H	85-87	MSB-302	MSR-302
GSX-R750 J/K	88-89	MSB-303	MSR-302
GSX-R750 L	90	MSB-302	MSR-302
GSX-R750 M	91	MSB-302	MSR-302
GSX-R750	96-03	MSB-302	MSR-303
GSX-R750RG	86	MSB-302	MSR-302
GSX-R750W	92-97	MSB-302	MSR-303
GSX-R750	04-07		MSR-305
GSX-R750	08-09		MSR-305
VS750GLP G-H	86-87	MSB-303	
VS750GLP J/K/L/M	88-91	MSB-304	
DR800S L-V	90-97	MSB-304	MSR-303
VL800	01-08	MSB-307	
VS800GL N-V	92-97	MSB-304	
VS800GL W	98	MSB-304	
VS800GL	01-03	MSB-307	
VX800(U)L-V	90-94	MSB-304	MSR-303
VX800(U)L-V	95-97	MSB-304	MSR-303
VZ800V	97	MSB-307	
VZ800	98-09	MSB-307	
GS850G T-D	80-83	MSB-301	MSR-301
GS850G E	84	MSB-301	
GS850GL Z/D	82-83		MSR-301
RF900R R-V	94-97	MSB-302	MSR-303
DL1000	02-09	MSB-302	MSR-305
GS1000 C/N	78-79		MSR-301
GS1000E C/N/T	78-80		MSR-301
GS1000G T/X	80-81	MSB-301	MSR-301
GS1000GL T/X	80-81		MSR-301
GS1000L N	79		MSR-301
GS1000S N	79		MSR-301
GS1000S T	80		MSR-301
GS1000S Z	82	MSB-301	MSR-301
GSX-R1000	01-02	MSB-302	MSR-303
GSX-R1000	03-04	MSB-310	MSR-305
GSX-R1000	05-06	MSB-311	MSR-305
GSX-R1000	07-08	MSB-311	MSR-305
TL1000R	98-03	MSB-302	MSR-303
TL1000S	97-00	MSB-303	MSR-303
GS1100E	80-82		MSR-301
GS1100E	83		MSR-301
GS1100ES	83		MSR-301
GS1100G	82-83	MSB-301	MSR-301

MODEL	YEAR	FRONT	REAR
GS1100GK	84		MSR-301
GS1100GL	82-83		MSR-301
GS1100K	82-83		MSR-301
GS1100L	80		MSR-301
GS1100S	83		MSR-301
GSX1100E	80-81		MSR-301
GSX1100E	84-86	MSB-301	
GSX1100ES	84-86	MSB-301	
GSX1100EF	84-86	MSB-301	
GSX1100F	88-92	MSB-303	
GSX1100F	93	MSB-303	
GSX1100F	94	MSB-303	
GSX1100G	91-92	MSB-302	MSR-303
GSX1100G	93-94	MSB-302	
GSX-R1100	86-88	MSB-302	MSR-302
GSX-R1100	91-92	MSB-303	MSR-302
GSX-R1100W	93-94	MSB-302	MSR-303
GSX-R1100W	95-96	MSB-302	MSR-303
GSX-R1100W	97	MSB-302	MSR-303
GS1150EF/ESG	85-86	MSB-301	
GSF1200(S)	96-00	MSB-302	MSR-303
GSF1200	01-02	MSB-302	MSR-303
GSX1200X	99	MSB-302	MSR-303
GV1200GL	85-86	MSB-302	
GSF1250	07-10	MSB-303	MSR-305
GSX1300R	99	MSB-302	MSR-303
GSX1300R	00	MSB-302	MSR-303
GSX1300R	01-02	MSB-302	MSR-303
GSX1300R	03	MSB-302	MSR-303
GSX1300R	04-07	MSB-302	MSR-303
GSX1300R	08-09	MSB-311	MSR-303
GV1400GC			
CAVALCADE	86-87	MSB-302	
GV1400GD G/H/J	86-88	MSB-302	
GV1400GT	86-87	MSB-302	
VS1400GLFH			
INTRUDER	87	MSB-304	
VS1400GLP	87-95	MSB-304	
VS1400GLP	96-03	MSB-307	
VS1400	04-09	MSB-307	MSB-309
VL1500	05-06	MSB-302	MSR-303
VL1500 W/X/Y	98-00	MSB-307	MSR-303
		YAMAHA	
RD80LC	82	MSB-207	
YZ80	92	MSB-205	
YZ80	93-95	MSB-205	MSR-213
YZ80	96	MSB-205	MSR-213
YZ80	97-01		MSR-213
YZ85	02-05		MSR-213
DT125LC	87	MSB-205	
DT125R	88-89	MSB-209	MSR-213
DT125R	90-96	MSB-209	
DT125RE	93	MSB-209	
RD125LC	82	MSB-207	
TDR125	96	MSB-215	
TDR125	99	MSB-209	
TZR125	97	MSB-207	
XV125	97	MSB-207	
XV125	99	MSB-207	
XV125S	99	MSB-207	
XVS125	01	MSB-207	
YZ125	92	MSB-211	MSR-213
YZ125	93-95	MSB-211	MSR-213
YZ125	96-01		MSR-214
YZ125	02	MSB-218	MSR-214
YZ125	03-07	MSB-218	MSR-217
YZ125	08-10		MSR-217
FZR250R-3/5/6/7 (3LN)	90-93	MSB-202	
RD250LC	82	MSB-207	
SRX250T/TC	87	MSB-204	

MODEL	YEAR	FRONT	REAR
TZR250	88	MSB-202	
WR250ZJ	97		MSR-214
WR250F	01-02		MSR-214
XV250U/UC/W/WC	88-89	MSB-204	
XV250A/AC VIRAGO	90	MSB-204	
XV250	94-98	MSB-204	
YP250	97-98	MSB-209	
YP250D	98	MSB-209	
YZ250	92	MSB-211	MSR-213
YZ250	93-95	MSB-211	MSR-213
YZ250	96-01		MSR-214
YZ250	02	MSB-218	MSR-214
YZ250	03-07	MSB-218	MSR-217
YZ250F	01		MSR-214
YZ250F	02	MSB-218	MSR-214
YZ250F	03-06	MSB-218	MSR-217
YZ250F	08-09		MSR-217
RD350LC	82	MSB-201	
RD350LC	83-84	MSB-201	MSR-203
RD350 <1JF/1JG>	85		MSR-203
RD350LCF 88H/N			MSR-203
TT350T	87-89	MSB-209	
WR250F	02		MSR-214
WR250FP	02		MSR-214
XT350U/W	88-89	MSB-205	
XT350A/B/C	90-92	MSB-205	
FZR400 (1WG)	86-88		MSR-202
FZR400A/SAC	90		MSR-202
FZR400R (1WG)	87-89		MSR-202
FZR400U/SUC/W/S WC	88-89		MSR-202
XS400 D/E/F	77-79	MSB-206	
XS400 J/K MAXIM	82-83	MSB-204	
XS400R/RK SECA	82-83	MSB-204	
XS400S G	80	MSB-206	
XS400S H	81	MSB-206	
WR400F	01-02		MSR-214
YZ426F	01-02	MSB-218	MSR-214
WR426F	01-02		MSR-214
YZ450F	03-07	MSB-218	MSR-217
YZ450F	08-09		MSR-217
SR500E/F/G/H	78-81	MSB-206	
SR500	82	MSB-206	
SR500	84	MSB-207	
XS500 C/D/E	76-78	MSB-206	MSR-211
XV500K VIRAGO	83	MSB-204	
XV535	87-01	MSB-202	
XV535SE	88	MSB-202	
XV535S	94-97	MSB-202	
XJ550	83	MSB-201	
XJ550 H/J/K MAXIM (USA)	81-83	MSB-206	
XJ550RH (USA)	81	MSB-204	
XJ550R/RK (USA)	82-83	MSB-204	
XZ550	82	MSB-201	
XZ550RJ	82	MSB-204	
XZ550RK VISION	83	MSB-210	
FZR600 U/S/T	86-88		MSR-201
FZR600 W	89		MSR-202
FZR600 A/B	90-91		MSR-202
FZR600 D	92		MSR-202
FZR600R E	93		MSR-202
FZR600R F/G	94-95		MSR-202
FZR600R H	96		MSR-202
FZR600R J	97		MSR-202
FZR600 <3HE/ERG/ERH>	93		MSR-202
FZR600 4JH/4HM	94-95	MSB-208	
FZS600	98-03	MSB-213	
TT600L	84	MSB-209	

MODEL	YEAR	FRONT	REAR
TT600T	86-88	MSB-209	
TT600W	89-92	MSB-209	
XT600 S/T	86-87	MSB-204	
XT600 U/W	88-89	MSB-204	
XT600E	91	MSB-204	
XT600E	94	MSB-204	
XT600E	96-97	MSB-204	
XT600H/N	87	MSB-209	
XT600Z	88	MSB-209	MSR-203
YZF600RG/RH	95-96	MSB-208	
YZF600R	96-99	MSB-212	
YZF600R	00-05	MSB-212	
YZF-R6	99-00	MSB-212	
YZF-R6	01-04	MSB-217	
FZS600	01-02	MSB-213	
FZS600P	02	MSB-213	
FZS600S	01	MSB-213	
FZS600SN	01	MSB-213	
XJ650 G	80	MSB-202	
XJ650 H/J	81-82	MSB-202	
XJ650	83	MSB-201	
XJ650K	83	MSB-202	
XJ650LH	81	MSB-202	
XJ650LJ/LK	82-83	MSB-210	
XJ650RJ SECA	82	MSB-210	
XS650 D/E/F single disc	77-79	MSB-206	
XS650 E/E/F double disc	77-79	MSB-203	
XS650 double discs	80	MSB-203	
XS650G special II	80	MSB-206	
XS650H single disc	81	MSB-206	
XS650H double disc	81	MSB-203	
XS650S E/F/G single disc	78-80	MSB-206	
XS650S E/F/G double disc	78-80	MSB-203	
XS650S H	81	MSB-206	
XS650SJ/SK single disc	82-83	MSB-206	
XS650SJ/SK double discs	82-83	MSB-203	
XS650SE	80	MSB-206	MSR-211
XTZ660	91	MSB-202	
XTZ660	92-95	MSB-202	
XT660R	04-05	MSB-215	MSR-213
XT660R	06-09	MSB-215	MSR-213
XT660X	04-05	MSB-215	MSR-213
XT660X	06-09	MSB-215	MSR-213
MT-03	06-09		MSR-213
XJ700 N/S MAXIM	85-86	MSB-210	
XV700 L/N	84-85	MSB-210	
XV700C	86-87	MSB-210	
XV700S	86	MSB-210	
YZF-R7	99	MSB-212	
FZ750 N	85		MSR-204
FZ750 S	86		MSR-204
FZR750RT/RU	87-88		MSR-205
XJ750 J/K MAXIM	82-83	MSB-210	
XJ750M K MIDNIGHT MAXIM	83	MSB-210	
XS750 D/2D/E/F	77-79	MSB-203	MSR-211
XS750S E/F	78-79	MSB-203	MSR-211
XS750SE	80	MSB-203	MSR-211

MODEL	YEAR	FRONT	REAR
XTZ750	89	MSB-202	
XTZ750	90	MSB-202	
XTZ750	91-97	MSB-202	
XV750 H/J/K	81-83	MSB-202	
XV750M K	83	MSB-202	
XV750 U/W	88-89	MSB-210	
XV750 A/B/D	90-92	MSB-210	
XV750 E/F	93-94	MSB-210	
XV750 G/H	95-96	MSB-210	
XV750H1/J1			
VIRAGO	96-97	MSB-210	
XV750SE	82	MSB-202	
YZF750R F/G/H	94-96	MSB-208	
YZF750R J	97	MSB-208	
YZF750SP	93-94	MSB-208	
YZF750SP	96-97	MSB-208	
TRX850	96	MSB-208	
TRX850	97-98	MSB-208	
XS850 G/H	80-81	MSB-203	MSR-211
XS850L G/H	80-81	MSB-203	MSR-211
XS850S G/H	80-81	MSB-203	MSR-211
TDM900	02-03	MSB-213	
XJ900F	83-84	MSB-201	
XV920RH	81	MSB-201	
XV920J VIRAGO	82	MSB-210	
XV920K/MK VIRAGO	83	MSB-202	
FZR1000 2LA	87		MSR-205
FZR1000 T/U	87-88		MSR-205
FZR1000 W/A	89-90	MSB-210	MSR-206
FZR1000 B	91	MSB-208	MSR-206
FZR1000 D	92	MSB-208	MSR-206
FZR1000 E	93	MSB-208	MSR-206
FZR1000 F	94	MSB-208	MSR-206
FZR1000 G	95	MSB-208	MSR-206
FZS1000	01-05	MSB-213	
XV1000	82	MSB-201	
XV1000 L/N	84-85	MSB-210	MSR-212
XV1000	86-87	MSB-201	
YZF1000R	96-01	MSB-212	
YZF-R1	98-99	MSB-212	
YZF-R1	02-03	MSB-212	
FJ1100 L/N	84-85		MSR-204
XJ1100 J MAXIM	82	MSB-202	
XS1100 E/F/G/H	78-81	MSB-203	MSR-212
XS1100L G MIDNIGHT SPECIAL	80	MSB-203	MSR-212
XS1100L H MIDNIGHT SPECIAL	81	MSB-202	
XS1100S F/G	79-80	MSB-203	MSR-212
XS1100S H	81	MSB-203	MSR-212
XV1100 S/T/U/W/A/E/F/G/H/J	86-97	MSB-210	
XV1100S H/J	96-97	MSB-210	
VIRAGO	88		MSR-204
FJ1200 U	88		MSR-204
FJ1200 W/A/B/D	89-92		MSR-204
FJ1200AD/ADC/AE/AEC(ABS)			MSR-204
VMX12N/S/U/W V-MAX	85-89		MSR-213
VMX12A/B/D	90-92		MSR-213
VMX12E/EC V-MAX	93		MSR-213
VMX12F/FC/G/GC V-MAX	94-95		MSR-213
VMX12H/HC/J/JC V-MAX	96-97		MSR-213

MODEL	YEAR	FRONT	REAR
XJR1200	95	MSB-210	
XVZ12DL/DKC2 VENTURE ROYALE	84	MSB-204	
XVZ12DN VENTURE ROYALE	85	MSB-204	
XVZ12L/KC2	84	MSB-204	
XVZ12TDK	83	MSB-204	
XVZ12TK	83	MSB-204	
XJR1300	99	MSB-213	
XJR1300	00-03	MSB-213	
XV13AH<4NL1>	96	MSB-210	MSR-213
XVZ13ATH/ATHC ROYAL STAR	96		MSR-213
XVZ13LTJ/LTJC ROYAL STAR	97		MSR-213
XVZ13TF	00	MSB-210	MSR-213
XVZ13 CT	08	MSB-210	MSR-213
XVZ1300A	00	MSB-210	MSR-213
XV1600A	99-00	MSB-210	
XV1600	02	MSB-210	
XV17	00-02	MSB-216	
XV17 PCM	08	MSB-216	MSR-213

REMARKS: MSB-407: supplied without Washer
(43022-1009)

MSR-101: supplied without bolt

MSB-118 no longer available

MSB-105 BECOME AVAILABLE AGAIN

MODEL	YEAR	FRONT	REAR
-------	------	-------	------

MSR-401

DUST CAP IS NOT INCLUDED.



MASTER CYLINDER RESERVOIR REBUILD KIT

(For Front & Rear Brake)



HONDA

RVR-101	Front	1X RESERVOIR TANK,SQUARE	CB250N/NA	79-80
		1X RESERVOIR CAP	CB400T-2 HAWK II	79
		1X DIAPHRAGM	CB400T HAWK	80
		1X O RING	CB400N/NA	79-80
		4X SCREW	CM400T(Z/A)	79-80
			CM400A(Z/A)	79-80
			CB650	79-80
			CB650C CUSTOM	80
			CB750C CUSTOM	80
			CB750K	79-80
			CB750L	79
			CB750F SUPERSPORT	79-80
			GL1000 K GOLDWING	79
			CBX SUPERSPORT	79-80
			CB900C CUSTOM	80-81
GL1100 GOLDWING	80-81			
GL1100I INTERCEPTOR	80-81			

RVR-102	Front	1X RESERVOIR TANNK,SQUARE	CB250NDc	82
		1X RESERVOIR CAP	CB400T HAWK	81
		1X DIAPHRAGM	CB400C	82
		1X O RING	CM400TB/TC	81-82
			CB450T HAWK	82
		2X SCREW	CM450A HONDAMATIC	82-83
			CM450C CUSTOM	82
			CX500C CUSTOM	81-82
			CX500D DELUXE	81
			CX500TC	82
			GL500 SILVERWING	81-82
			GL500I INTERSTATE	81-82
			CB650	81-82
			CB650SC NIGHTHAWK	82
			CB450SC NIGHTHAWK	82-83
			GL650 SILVERWING	83
			GL650I INTERSTATE	83
			CB750C CUSTOM	81-82
			CB750K	81-82
			CB750F SUPERSPORT	81-82
			CB750SC NIGHTHAWK	82-83
			CB900F SUPERSPORT	81-82
			CB900C CUSTOM	82
			CB650 CUSTOM	81-82
			CBX SUPERSPORT	81-82
			CB1100RB/RC/RD	81-83
			GL1100 GOLDWING	82-83
			GL1100I INTERSTATE	82-83
			GL1100A ASPENCADE	82-83

RVR-103	Front	1X RESERVOIR TANNK,ROUND	GL1000	75
		1X RESERVOIR CAP	GL1000 LTD	76
		1X DIAPHRAGM	GL1000K1	77
		1X O RING	GL1000K2	78
		2X SCREW	W/O OIL CAP PLATE	

RVR-104	Front	1X RESERVOIR TANK ROUND	CBR900RR	93-03
		1X DIAPHRAGM	CBR1000RR	04-05
		1X RESERVOIR CAP	CBR900RE	2001
		2X FLAT SCREW 4X50	VTR1000SP	00-06
			VTR1000F	97-00
	RVF750	94-95		

RVR-105	Rear	1X RESERVOIR TANK SQUARE	VTR1000F	97-06
		1X DIAPHRAGM	CB1000	93-96
		1X RESERVOIR CAP	CBR1000RR	04-07
		2X FLAT SCREW 4X40	CBR600RR	03-08
			FMX650	05-06
			GL1500C	97-03
GL1500CD	01-03			
	GL1500CF	99-01		
	GL1500CT	97-00		

RVR-106	Rear	1X RESERVOIR TANK ROUND	CR125R	90-01
		1X DIAPHRAGM	CR250R	90-01
		1X RESERVOIR CAP	CR80R	92-02
			CR80RB	96-02
			CR85R	03-07
			CR85RB	03-07
			XR250L	91-96
			XR250R	90-04
			XR400R	96-04
			XR600R	91-00
			XR650R	00-07
			TRX400EX	99-08
			TRX450R	04-09
			TRX450ER	04-09
			TRX700XX	08-09

RVR-107	Rear	1X RESERVOIR TANK ROUND	CB1100SF	00-01
		1X DIAPHRAGM	CBR1100XX	97-06
		1X RESERVOIR CAP	CBR1000F	93-99
			CBF1000F	06-08
			CBF1000A	06-08
			CBF1000S	07-08
			CBF1000T	07-08
			CB600F	07-08
			CB600FA	07-08
			CB600N/NA	2008
			CB600S/SA	2008
			ST1300	02-08
			ST1300A	02-08
			ST1100A	96-02
			VFR800F1	98-01
			VFR800	02-09
			VTX1800C	02-04
			VTX1800C1	05-08
			XL1000V	00-08
			XL1000VA	04-08
NT600V	02-05			
NT700V	05-08			

RVR-108	Rear	1X RESERVOIR TANK ROUND	CBR900RR	93-03			
		1X DIAPHRAGM	CBR900RE	2001			
		1X RESERVOIR CAP	CBR600F	93-06			
			CBR600F3	95-98			
			CBR600F4	99-04			
			CBR600FR	01-02			
			CBR600FS	01-02			
			CB900F	02-07			
			CB600F	98-06			
			CB500S	98-02			
			CB500	97-02			
			CB750F2	94-01			
			VTX1300S	03-07			
			VTR1000SP	00-01			
			VT1100C2	95-96			
			VT1100C2	00-05			
			VFR750F	94-97			
			FX650	99-00			
			NT650V	98-01			
			RVF750R	94-95			
			XR750	93-00			
			SLR650	97-98			
			TRX650FA	03-08			
			TRX680FA	07-08			
			RVR-109	Rear	1X RESERVOIR TANK SQUARE	CBR600F	87-90
					1X DIAPHRAGM	CB400F	89-90
					1X RESERVOIR CAP	VFR750F	90-93
					2X FLAT SCREW 4X40	XL600V	93-99
						XL650V	00-06
						XL700VA	2008

YAMAHA

RVR-201	Front	1X RESERVOIR TANK ROUND	YZF-R1	00-01
		1X DIAPHRAGM		
		1X RESERVOIR CAP		

RVR-202	Front	1X RESERVOIR TANK ROUND	YZF-R6	03-04
		1X DIAPHRAGM		
		1X RESERVOIR CAP		

SUZUKI

RVR-301	Front	1X RESERVOIR TANNK,SQUARE	GN400XT/XX	80-81
		1X RESERVOIR CAP	GS450ET/EX/EZ/ED	80-83
		1X DIAPHRAGM	GS450ST/SX	80-81
		1X O RING	GS750ET/EX	80-81
		4X SCREW	GS850GT/GX	80-81
			GS1000GT/GX	80-81

KAWASAKI

RVR-401	Front	1X RESERVOIR TANK,ROUND	ZX750H1/H2 NINJA ZX-7	89-90
		1X RESERVOIR CAP	ZX750J1/J2 NINJA ZX-7	91-92
		1X DIAPHRAGM	ZX750K1/K2 NINJA ZX-7R	91-92
		1X O RING	ZX750M1/M2 NINJA ZX-7R	93-94
		1X BOLT	ZX750L1-L3 NINJA	93-95
			ZX750N1/N2 NINJA ZX-7R	96-97
			ZX750P1-P3 ZX-7R	96-98
			ZX900C1 NINJA ZX-9R	98

RVR-402 REAR	1 X RESERVOIR TANK ROUND	EX250E1/E2 NINJA 250R	86-87	
	1 X DIAPHRAGM	EX250F6-19 NINJA 250R	92-95	
	1 X RESERVOIR CAP	EX250F6F/F7F NINJA 250R	06-07	
		EX250J8F/J9F NINJA 250R	08-09	
		VN800C1/C2 DRIFTER	99-00	
		VN800E1-E5 DRIFTER	01-05	
		VN800E6F DRIFTER	2006	
		VN1500A1 VULCAN 88	1987	
		VN1500A2-A13 VULCAN	96-99	
		VN1500B1-B4 VULCAN	87-90	
		VN1500C3/C4 VULCAN	96-97	
		ZX1000A1/A2 NINJA	86-87	
		ZX1000B1-B3 ZX-10	88-90	
		ZX1000D6F/D7F ZX-10R	06-07	
		ZX1200C1-C4 ZZR1200	02-05	
		ZX1100C1-C4 ZX-11	90-93	
		ZX1100D1-D9 ZX-11	93-01	
		ZX750F1-F4 NINJA 750R	87-90	
		ZX750H1/H2 ZX-7	89-90	
		ZX750J1/J2 ZX-7	91-92	
		ZX750K1/K2 ZX-7R	91-92	
		ZX750L1-L3 ZX-7	93-95	
		ZX750M1/M2 ZX-7R	93-94	
		ZX600N1 ZX-6RR	2005	
		ZX600N6F ZX-6RR	2006	
		ZX636C1 ZX-6R	2005	
		ZX636C6F ZX-6R	2006	
		ZX600D6F ZX-6R	2006	
		ZR750C1-C3 ZEPHYR	91-93	
		ZR750F2 ZR-7	2000	
		ZR750H1-H3 ZR-7S	01-02	
		ZR750K1 ZR-7S	2005	
		ZR750K6F Z750S	2006	
		ZR1000A1-A3 Z1000	03-05	
		ZR1000A6F Z1000	2006	
		ZR1100C3/C4 ZRX1100	99-00	
		ZR1200A1-A5 ZRX1200R	01-05	
	RVR-403 REAR	1 X RESERVOIR TANK ROUND	ZXR400H2	1990
		1 X DIAPHRAGM	XZR400L1-L9	91-99
		1 X RESERVOIR CAP	ZX600F1-F3 ZX-6R	95-97
		ZX600G1/G2 ZX-6R	98-99	
		ZX600J1P/J2P	00-01	
		ZX600RR K1H/M1H ZX-6RR	03-04	
		ZX600D1	1990	
		ZX600E1-E11	93-03	
		ZX600E12H/E13H	04-05	
		ZX636A1P ZX-6R	2002	
		ZX636B1H/B2H ZX-6R	03-04	
		ER-6 A6F-A8F	06-08	
		ER-6 D9F ABS	2009	
		ER-6 C9F	2009	
		ER-6N A6F-A8F	06-08	
		ER-6N B6F-B8F	06-08	
		ER-6N D9F	2009	
		ZX750P1-P7 ZX-7R	96-02	
		ZX750RR N1 ZX-7R	1996	
		ZX900A1-A3	84-86	
		ZX900B1-B4 ZX-9R	94-97	
		ZX900C1/C2 ZX-9R	98-99	
		ZX900E1P/E2P ZX-9R	00-01	
		ZX900F1P/F2P ZX-9R	02-03	
		ZX1000C1H/C2H ZX-10R	04-05	
		GPZ1100E1/E2	95-97	
		ZR1100A1-A4 ZEPHYR	92-95	
		ZX1200A1H/A2H ZX-12R	00-01	

YAMAHA/SUZUKI/KAWASAKI

RVR-901 FRONT	1 X RESERVOIR TANK ROUND	YZF600R	96-02
	1 X DIAPHRAGM	YZF750SP	93-95
	1 X RESERVOIR CAP	YZF750R	93-96
	1 X DIAPHRAGM PLATE	YZF1000R	96-00
		FZR1000	91-95
		YZF-R6	99-02
		YZF-R7	99-00
		YZF-R1	98-99
		YZF-R1	02-03
		GSX-R600WN/WP	92-93
		GSX-R600	97-09
		GSX-R750J/K/L	88-90
		GSX-R750M/N	91-92
		GSX-R750WP/WR/WS	93-95
	GSX-R750T-X	96-99	
	GSX-R750	00-08	
	GSX-R1000	01-09	
	TL1000S	97-01	
	TL1000R	98-03	
	SV650	99-08	
	SV650A	03-08	
	SV650S	99-08	
	SV650SA	03-08	
	SV1000	03-07	
	SV1000S	03-07	
	ZXR400H2	1990	
	ZXR400L1-L9	91-99	
	ZX600G1/G2 ZX-6R	98-99	
	ZX600J1P/J2P ZX-6R	00-01	
	ZX600P7F/P8F ZX-6R	07-08	
	ZX600R9F ZX-6R	2009	
	ZX600K1H/M1H ZX-6RR	03-04	
	ZX636A1P ZX-6R	2002	
	ZX636B1H/B2H ZX-6R	03-04	
	ZX636C1H ZX-6R	2005	
	ZX636C6F ZX-6R	2006	
	ZX750P1-P7 ZX-7R	96-02	
	ZX750N1/N2 ZX-7RR	96-97	
	ZX750L7F-L9F	07-09	
	ZXR750H1/H2 STINGER	89-90	
	ZXR750J1/J2 ZX-7	91-92	
	ZXR750L1-L3	93-94	
	ZXR750K1/K2 ZX-7R	91-92	
	ZXR750M1/M2 ZX-7R	93-94	
	ZX900C1/C2 ZX-9R	98-99	
	ZX900E1P/E2P ZX-9R	00-01	
	ZX900F1P/F2P ZX-9R	02-03	
	ZX900F1H/F2H ZX-9R	02-03	
	ZX1000C1H/C2H ZX-10R	04-05	
	ZX1000D6F/D7F ZX-10R	06-07	
	ZX1000E8F/E9F ZX-10R	08-09	
	Z1000C7F-C9F ABS	07-09	
	Z1000B7F-B9F	07-09	
	ZX1400A6F/A7F	06-07	
	ZX1400B6F/B7F ABS	06-07	
	ZX1400D8F/D9F	08-09	

RVR-103 Oil cap plate is not included

RVR-101 DIAPHRAGM PLATE IS NOT INCLUDED

BRAKE MASTER CYLINDER RESERVOIR CAP & DIA. SET (FRONT)

HONDA

RCD-101	VF500F INTERCEPTOR	84-86
	VF500C MAGNA	84-85
	VT500C SHADOW	84-86
	CB700SC	84-86
	VF700C MAGNA	84-85
	VF700S SABRE	84-85
	VT700C SHADOW	84-87
RCD-102	VF700F INTERCEPTOR	84-85
	VF750F INTERCEPTOR	83-84
	VF1000F INTERCEPTOR	84
	VF1000R	85-86
	VF1100 MAGNA	83-86
	VF1100S SABRE	84-85
	VT1100C SHADOW	85-86
	CBR600F HURRICANE	87-90
	GL1200 GOLDWING	84-85
	GL1200I INTERSTATE	84-87
	GL1200A ASPENCADE	84-87
RCD-103	CBR600F2 HURRICANE	91
	PC800 PACIFIC COAST	89-90
	GL1500 GOLDWING	88-90
	GL1500SE GOLDWING SE	90-91
	GL1500A ASPENCADE	91
RCD-104	GL1500I INTERSTATE	91
	CB500/K1/K2	71-73
	CB550K/K1	74-75
	CB550	76
	CB550K/K1	77-78
	CB550F SUPERSPORT	76-77
	CB750A HONDAMATIC	76-78
	CB750F SUPERSPORT	76
CB750K	69-78	



SUZUKI

RCD-302	GSX600FJ KATANA	88
	GSX1100FJ KATANA	88
	GSX1100FK/FL/FM/FN/FP	89-93
	GSX-R1100K/L	89-90

KAWASAKI

RCD-401E	Z1/A/B	73-75
	KZ650B1-B3	77-79
	KZ900A4/A6	76-77

RCD-402E	KZ650C1-C3	77-79
	KZ750B1-B4	76-79
	KZ900B1 LTD	76
	KZ1000A1-A2	77-78

RCD-405	KZ1000B1/B2 LTD	77-78
	KZ1000C1 POLICE	78

RCD-406	KZ550A1/A2	80-81
	KZ550C3/C4 LTD	82-83
	KZ550D1	81
	KZ650F1	80
	KZ650E1	80
	KZ650H1/H2 CSR	81-82
	KZ750G1 LTD	80
	KZ750H1/H2 LTD	80-81
	KZ750E1/E2/E3	80-82
	KZ750M1 CSR	82
	KZ1000C4 POLICE	81
	KZ1000E1/E2 SHAFT	79-80
	KZ1000G1 CLASSIC	80
	KZ1000K1/K2 LTD	81-82
	KZ1000M1/M2 CSR	81-82
KZ1000P1-P9 POLICE	82-90	

RCD-408	KZ1100A1-A3	81-83
	KZ1100B1/B2 GP	81-82
	EX500A1-A3	87-89
	EX500A4-A7	90-93
	ZR550B1 ZEPHYR	90
	ZX600B1 NINJA	87
	ZX600D1 NINJA ZX-6	90
	ZX600A1/A2/A3	85-87
	ZX600C1-C4	88-91
	ZR750C1-C3	91-93

KAWASAKI

RCD-407	ZL600A1/A2	86-87
	ZX750F4 NINJA	90
	ZX750F1-F3 NINJA	87-89
	ZL900A1/A2 ELIMINATOR	85-86
	ZX900A1/A2/A3 NINJA	84-86
	ZG1000A1-A6 CONCOURSE	86-91
	ZL1000A1	87
	ZX1000A1/A2 NINJA	86-87
	ZX1000B1-B3	88-90
	ZX1100C1-C2	90-91
	ZG1200A1	86
RCD-408	ZG1200B1-B5	87-91
	EX500D1-D5	94-98
	ZX600E1-E6	93-98
	ZX600F1-F3	95-97
	ZX600C5-C9	92-96
	ZX900B1-B4	94-97
	ZG1000A7-A13	92-98
	ZR1100A1/A2/A3	92-94
	ZX1100E1/E2/E3 GPZ	95-97
	ZX1100C3/C4 ZX-11	92-93
ZX1100D1-D6 ZX-11	93-98	
ZG1200B6-B12	92-98	

SUZUKI

RCD-301	GS450LZ/TZ	83
	GS450LD	83
	GS450GAF	85
	GS450GAZ/GAD	82-83
	GS450LF/LG/LH/LJ	85-88
	GS550ED/ESD	83
	GS550ES3/ESE/EF/ESF/ESG	83-86
	GS550LF/LG	85-86
	GS550LD	83
	GS650GD/GLD	83
	GS650MD KATANA	83
	GS750EZ	82
	GS750ED/ESD/SD	83
	GS750TZ/TD	82-83
	GS750EF	85
	GS750ESF	85
	GS850GZ/GD	82-83
	GS850LZ/GLD	82-83
	GS1000SZ	82
	GS1100GZ/GD	82-83
	GS1100SD	83
	GS1100GLZ/GLD	82-83
	GS1100EZ/ED/ESD	82-83
	GS1100KGZ/KGD/KGE	82-84
	GS1150	83-86
	GS500E(K-W)	89-98
	GSX600F(K-V) KATANA	89-97
	GSX750F(K-V) KATANA	89-97
	RF600RR/RS/RT	94-96
	RF900RR/RS/RT/RV/RW	94-98
	GSX-R750RG	86
	GSX-R750H	87
	GSX-R1100G/H/J	86-88
	GSX-R1100M/N	91-92
	GSX-R1100W(P-W)	93-98
	GSF400M/N/P BANDIT	91-93
	GSF600ST/SV/SW BANDIT	96-98
	GSF1200SV/SW	97-98

RCD-401E/RCD-402E
Reservoir cap is supplied by
Plastic black cap

RCD-403 IS NO LONGER AVAILABLE

CALIPER PAD PIN SETS (FOR ONE CALIPER)

SET IS FOR ONLY ONE CALIPER



TOUR X
MAX
HI PERFORMANCE EQUIPMENT

MC ID	DETAILS		FRONT	REAR					
PPS-901	2 X PAD PIN 2 X PIN PLUG (4 PCS/SET)	HONDA	(00-05)	NES125Y-5	(95-97)	VT1100C2 SHADOW			
			(88-96)	NX500J-T					
			(88-96)	NX650J-T					
			(91-93)	XL600VM-VP TRANSALP					
			1987)	XR600RH					
			(88-89)	XRV650J/K					
			(90-92)	XRV750L-N AFRICA TWIN					
			(99-04)	VT125CX-C4					
			(01-02)	VT125C2-1.2					
			(88-92)	VT600CJ-CN SHADOW					
			1987)	VFR750FH					
			(87-95)	CBR600FH-FS					
			(87-88)	CBR1000FH/FJ					
			(88-89)	GL1500 GOLD WING					
			1990)	GL1500L GOLD WING					
			(91-96)	GL1500I GOLD WING					
			(91-97)	GL1500A GOLD WING					
			(90-96)	GL1500SE GOLD WING					
			PPS-902	1 X PAD PIN 1 X PIN PLUG (2 PCS/SET)	HONDA	(92-01)	CB750F2N-1 SEVEN FIFTY	(88-96)	NX500J-T
								(88-96)	NX650J-T
		(88-97)				NTV650J-V			
		(93-00)				XR600RP-RY			
		(00-05)				XR650RY-R5			
		(88-89)				XRV650J/K			
		(90-97)				XRV750L-V AFRICA TWIN			
		(98-01)				NT650VY-V1 DEAUVILLE			
		(97-05)				VTR1000FV-F5 FIRE STORM			
		(00-05)				VTR1000SPY-SP5			
		(00-04)				CB600FY-F4 HORNET			
		(00-01)				CB600F2Y/F2-1 HORNET			
		(02-05)				CB900F2-F5 HORNET			
		(99-05)				CBR600FX-F5			
		(01-02)				CBR600FR			
		(01-02)				CBR600FS			
		(92-03)				CBR900RRN-RR3			
		(96-02)				CR80R			
		(96-02)				CR80RB			
		(03-05)				CR85R			
		(90-99)			CR125R				
		(90-01)			CR250R				
		(90-01)			CR500R				
		YAMAHA				(03-06)	YZF-R6		
					(04-06)	YZF-R1			
					(04-05)	FZ-6 FAZER			
					(04-05)	FZ6-N FAZER			
					2005)	FZ6-NS FAZER			
					2006)	FZ1-N			
					2006)	YZF-R1S			
					2005)	R46			
					(97-06)	YZ125			
					(97-06)	YZ250			
					(01-05)	YZ250F			
					(00-01)	YZ426F			
					(03-05)	YZ450F			
					1998)	WR250			
					(01-02)	WR426			
					(01-04)	WR250F			
					(99-00)	WR400F			
		(03-04)			WR450F				
		SUZUKI				(96-00)	RM125T-Y		
					(01-04)	RM125K1-K4			
					(96-00)	RM250T-Y			
					(01-04)	RM250K1-K4			
					(05-06)	RM450K5-K6			
					(00-03)	DR-Z400Y-K3			
					(00-06)	DR-Z400SY-K6			
					(05-06)	DR-Z400EK5-K6			
		KAWA				(04-06)	RM-Z250K4/K5/K6		
					(05-06)	RM-Z450K5/K6			
					(95-01)	KX125K2/K3/K4/K5/L1/L2/L3			
					(02-05)	KX125L4/M1/M2/M3			
					(95-01)	KX250K2/K3/K4/K5/L1/L2/L3			
					(02-05)	KX250L4/M1/M2/R1			
					(92-97)	KX500E4-E9			
					(98-03)	KX500E10-E15			
		(04-05)	KX250F-N1/N2						
		2006)	KX450F-D6F						
		(97-05)	KLX300A2-A10						
		(96-01)	KLX650D1-D6						

MC ID	DETAILS		FRONT	REAR	
PPS-903	1 X PAD PIN 1 X PIN PLUG (2 PCS/SET)	HONDA	(88-93) NX250J-P		
			(97-99) XL600VV-VX TRANSALP		
			(00-05) XL650VY-5 TRANSALP		
			(88-00) XR600RJ-RY		
			(00-05) XR650RY-5		
			(93-00) XRV750P-Y AFRICAN TWIN		
			(87-96) CR125R		
			(97-05) CR125R		
			(90-95) CR250R		
			(96-05) CR250R		
			(92-95) XR250R		
			(90-01) CR500R		
			2005) CRF250R		
			(04-05) CRF250X		
			(02-05) CRF450R		
		YAMAHA	(97-06) YZ125		
			(97-98) YZ250		
			(01-04) YZ250F		
			(98-99) YZ400F		
			(00-02) YZ426F		
			(03-05) YZ450F		
			1998) WR250		
			(01-04) WR250F		
			(98-99) WR400F		
			2003) WR450F		
			SUZUKI	(96-00) RM125T-Y	
		(01-06) RM125K1-K6			
		(96-00) RM250T-Y			
		(01-06) RM250K1-K6			
		(05-06) RM-Z450K5-K6			
		(00-03) DR-Z400Y-K3			
		(00-04) DR-Z400SY-K4			
		(05-06) DR-Z400EK5-K6			
		(05-06) DR-Z400SK5-K6			
		(05-06) DR-400SMK5-K6			
		(96-98) DR650SET-SEW			
		KAWA		(94-96) KX125K1/K2/K3	
				(94-96) KX250K1/K2/K3	
			(97-03) KX500E9-E15		
			(93-95) KLX250E1/E2/E3		
			(94-96) KLX250D2/D3/D4		
(97-05) KLX300A2-A10					
(93-95) KLX650C1/C2/C3					
(96-01) KLX650D1-D6					
(95-05) KDX200H1-H11					
(97-05) KDX220A4-A12					
PPS-903R 1 X PAD PIN		KAWA	(97-05) KX125K4/K5/L1/L2/L3/L4/M1/M2/M3		
			(97-05) KX250K4/K5/L1/L2/L3/L4/M1/M2/R1		
			(92-95) KX500E4-E8		
		SUZUKI	04-05) KX250F-N1/N2		
			2006) KX450F-D6F		
			(04-06) RM-Z250K4/K5/K6		
PPS-905	2 X PAD PIN 2 X PIN CLIP (4 PCS/SET)	YAMAHA	(88-90) FZR400	(89-93) FZR600	
			(86-87) FZ600S/T	(94-99) FZR600R	
			(86-87) FZ600SC/TC	(86-87) FZX700	
			1988) FZ600UU	(87-88) FZR750RT/RU	
			(88-93) FZR600	1985) FZ750N	
			(94-99) FZR600R	(86-90) FZ750	
			1987) FZ700T/TC	1988) FZX750	
			(86-87) FZX700	(87-95) FZR1000	
			1985) FZ750N	(95-02) YZF600R THUNDER CAT	
			(87-90) FZ750	(96-00) YZF1000R THUNDER ACE	
			1988) FZX750	1993) YZF750R	
			(87-88) FZR750RT/RU	1996) YZF750R	
			(87-90) FZR1000	(94-95) YZF-R7	
			1992) XV750 VIRAGO	1995) YZF-R7SP	
			(84-97) XV1100 VIRAGO	1993) GTS1000/A	
			1988) XV1100SE VIRAGO	(95-01) XJ900S DIVERSION	
			1991) FJ1200A	(91-01) TDM850	
			(86-92) FJ1200	(94-97) TRX850	
			(95-97) XJR1200	(86-01) V-MAX 1200	
			(96-97) TRX850	(86-92) FJ1200	
			(91-01) TDM850	1991) FJ1200A	
			(86-01) V-MAX 1200	(95-97) XJR1200	
			1983) XVZ12TK VENTURE	(99-01) XJR1300SP	
			1983) XVZ12TDK VENTURE	1983) XVZ12TK/TK VENTURE	
			1984) XVZ12L/KC2 VENTURE	1984) XVZ12L/KC2 VENTURE	
			1988) XVZ12D VENTURE	1984) XVZ12DL/DKC2 VENTURE ROYAL	
			1984) XVZ12DL/DKC2 VENTURE ROYAL	1985) XVZ12DN VENTURE ROYAL	
			1985) XVZ12DN VENTURE ROYAL	1988) XVZ12TD	
			(89-90) XVZ13TD	(86-87) XVZ13DS/DSC/DT/DTC VENTURE ROYAL	
			(87-88) XVZ13T/TC/U/UC VENTURE	(88-89) XVZ13DU/DUC/DW/DWC VENTURE ROYAL	
			(86-87) XVZ13DS/DSC/DT/DTC VENTURE ROYAL	(90-91) XVZ13DA/DAC/DB/DBC VENTURE ROYAL	
			(88-89) XVZ13DU/DUC/DW/DWC VENTURE ROYAL	(92-93) XVZ13DD/DDC/DE/DEC VENTURE ROYAL	
			(90-91) XVZ13DA/DAC/DB/DBC VENTURE ROYAL	(87-88) XVZ13T/TC/U/UC VENTURE	
			(92-93) XVZ13DD/DDC/DE/DEC VENTURE ROYAL	(89-90) XVZ13TD	
			(96-97) XVZ1300 ROYAL STAR	(96-00) XVZ1300 ROYAL STAR	
			(98-00) XVZ1300 ROYAL STAR	2000) XVZ13TF ROYAL STAR VENTURE	
				(99-02) XVS1100 BRAG STAR	
				(00-05) XVS1100A DRAG STAR CLASSIC	
				(02-06) BT1100 BULLDOG	
				(99-02) XV1600A WILD STAR	

MC ID	DETAILS		FRONT	REAR	
PPS-906	1 X PAD PIN 1 X PIN CLIP (2 PCS/SET)	SUZUKI	1996) GS500ET		
			(01-03) GS500K1-K3		
			(00-04) GSF600Y-K4 BANDIT		
			(05-06) GSF650K5-K6 BANDIT		
			(98-06) GSX600FW-FK6		
			(98-06) GSX750FW-FK6		
			(98-01) GSX750W-K1		
			(99-06) SV650X-K6		
			(90-91) DR650RSL/RSM		
			(92-03) DR650RN/RP		
			(91-93) DR650RSEM-RSEP		
			(94-95) DR650RER-RES		
			(88-89) DR750J/K		
			(01-06) VL800K1-K6 INTRUDER		
			(02-06) VL1500K2-K6 INTRUDER LC		
			(97-02) VZ800V-K2 MARAUDER		
			(05-06) VZ800K5/K6 INTRUDER		
			(04-06) DL650K4-K6 V-STROM		
			(02-06) DL1000K2-K6 V-STROM		
			(97-01) XF650V-K1 TREE WIND		
			(00-01) TU250XY-K1		
			KAWA	1999) ZR750F1 ZR-7 ZEPHYR	1999) ZR750F1 ZR-7 ZEPHYR
				2001) ZR750F3 ZR-7 ZEPHYR	2001) ZR570F3 ZR-7 ZEPHYR
				2005) ZR750F5 ZR-7 ZEPHYR	2005) ZR750F5 ZR-7 ZEPHYR
				(01-03) ZR750H1-H3 ZR-7S ZEPHYR	(01-03) ZR750H1-H3 ZR-7S ZEPHYR
				(04-05) ZR750J1H/J2H	(04-05) ZR750J1H/J2H
		2005) ZR750K1H Z750S		2005) ZR750K1H Z750S	
		2006) ZR750K6F Z750S		2006) ZR750K6F Z750S	
		(95-04) KL650C1-C10 KLR		(95-97) GPZ1100E1/E2 ZX-10	
		(95-97) GPZ1100E1/E2 ZX-10		2006) ER650A6S ER-6N	
		(01-03) ER500C1-C3 ER-5		(95-97) ZX600F1/F2	
		(04-05) ER500C4P/C5P ER-5		(98-99) ZX600G1/G2	
		(99-00) EJ650A1/A2 W650		(00-01) ZX600J1P/J2P	
		2006) ER650A6S ER-6N		2003) ZX600K1H	
		(01-02) EJ650C3/C4 W650		2004) ZX600M1H	
		2003) EJ650C5 W650		2006) ZX600N1H	
		(04-05) EJ650C6P/C7P W650		(03-04) ZX636B1H/B2H	
		2006) EJ650C6F W650		2005) ZX636C1H	
		(96-03) VN800B1-B8 CLASSIC		2006) ZX636C6F	
		(04-05) VN800B9P/B10P CLASSIC		(94-97) ZX900B1-B4	
		(99-01) VN800C1/C2 DRIFTER		(98-99) ZX900C1/C2	
		(99-00) VN1500J1/J2 DRIFTER		(00-01) ZX900E1P/E2P	
		2000) VN1500L1H CLASSIC TOURER		(02-03) ZX900F1H/F2H	
		(01-03) VN1500L2H-L4H CLASSIC TOURER F1		(02-03) ZX900F1P/F2P	
		(98-99) VN1500G1/G2 CLASSIC TOURER		(04-05) ZX1000C1H/C2H	
		(96-97) VN1500D1/D2 CLASSIC		(93-98) ZZR600E1-E6	
		(98-99) VN1500E1/E2 CLASSIC		(99-03) ZZR600E7-E11	
(00-02) VN1500N1H-N3H CLASSIC F1	(04-05) ZZR600E12H/E13H				
2005) VN1600D1H CLASSIC TOURER	2006) ZZR600E6F				
2006) VN1600D6F CLASSIC TOURER	(03-05) ZR1000A1H/A2H				
(03-05) VN1600A1H-A3H CLASSIC	2006) ZR1000A6F				
	2000) VN1500N1H CLASSIC F1				
	2000) VN1500L1H CLASSIC TOURER				
	(99-00) VN1500J1/J2 DRIFTER				
	(99-01) VN1500C1/C2 DRIFTER				
PPS-908	2 X PAD PIN 2 X PIN CLIP (4 PCS/SET)	SUZUKI	(88-97) GSX600FJ-FV	(89-96) GS500EK-ET	
			(89-97) GSX750FK-FV	(01-03) GS500K1-K3	
			(88-93) GSX1100FJ-FP KATANA	(88-97) GSX600FJ-FV	
			(85-87) GSX-R750F/G/H	(89-97) GSX750FK-FV	
			(86-88) GSX-R1100G/H/J	(88-93) GSX1100FJ-FP KATANA	
			(86-87) RG250G/H	(85-87) GSX-R750F/G/H	
			(95-97) VS600GLS-V INTRUDER	(88-92) GSX-R750J/K/L/M/N	
			(85-91) VS750GLF-M INTRUDER	(92-93) GSX-R750WN/WP	
			(92-97) VS800GLN-V INTRUDER	(86-92) GSX-R1100G-N	
			(87-95) VS1400GLH-S INTRUDER	(99-02) SV650X-K2	
			(96-01) VS1400GLPT-K1 INTRUDER	(90-94) XV800L-R	
			(98-01) VL1500W-K1 INTRUDER LC	(87-95) VS1400GLH-S INTRUDER	
				(96-98) VS1400GLPT-W INTRUDER	
				(98-01) VL1500W-K1 INTRUDER	
			(86-87) RG250G/H		
			(89-90) RGV250K/L		
			(92-93) GSX-R600WN/WP		
		KAWA	1990) ZXR400H2		
			(91-99) ZXR400L1-L9		
			(89-90) ZXR750H1/H2 ZX750		
			(91-92) ZXR750J1/J2 ZX750		
			1991) ZXR750K1 ZX750		
			(93-94) ZXR750M1/M2 ZX750		
			(93-95) ZXR750L1-L3 ZX750		
			(93-99) ZZR1100D1-D7 ZX1100		
			(97-99) ZRX1100D1-D3		
(01-03) ZRX1200R-A1P/A2P/A3P					
(01-03) ZRX1200S-B1P/B2P/B3P					
(01-03) ZRX1200C1P-C2P					
(04-05) ZRX1200R-A4H/A5H					
2004) ZRX1200S-B4H					
2004) ZRX1200C3H					
2006) ZRX1200R-A6F					

MC ID	DETAILS		FRONT	REAR	
PPS-909	1 X PAD PIN 1 X PIN CLIP (2 PCS/SET)	SUZUKI	(97-00) GSX-R600V-Y		
			(94-95) GSX-R750WR/WS		
			(96-99) GSX-R750T-X		
			(93-98) GSX-R1100WP-W		
			(01-05) GSF1200K1-K5 BANDIT		
			(98-00) TL1000RW-Y		
			(97-01) TL1000SV-K1		
			(92-94) RG125FN-P		
			(89-96) RGV250K-T		
			KAWA	1990) ZXR400H2	
				(91-99) ZXR400L1-L9	
				(89-90) ZX750H1/H2 ZXR	
				(91-92) ZX750J1/J2 ZXR	
				(91-92) ZX750K1/K2 ZXR	
				(93-94) ZX750M1/M2 ZXR	
				(93-95) ZX750L1/L2/L3 ZXR	
		(95-97) ZX600F1/F2/F3 ZX-6R			
		(98-99) ZX600G1/G2			
		(00-01) ZX600J1P/J2P			
		2002) ZX636A1P ZX-6R			
		(96-02) ZX750P1-P7 ZX-7R			
		(94-97) ZX900B1-B4 ZX-9R			
		(98-99) ZX900C1/C2			
		(00-01) ZX900E1P/E2P			
		(00-01) ZX1200A1H/A2H ZX-12R			
		(02-05) ZX1200B1H-B4H ZX-12R			
		(90-92) ZZR600D1-D3 ZX600			
		(93-98) ZZR600E1-E6 ZX600			
		(99-03) ZZR600E7-E11 ZX600			
		(90-92) ZZR1100C1-C3 ZX1100			
		(93-99) ZZR1100D1-D7 ZX1100			
		(97-99) ZRX1100D1-D3			
		(01-03) ZRX1200R-A1P/A2P/A3P			
		(01-03) ZRX1200S-B1P/B2P/B3P			
		KAWA		(04-05) ZRX1200R-A4H/A5H	
				2004) ZRX1200S-B4H	
				2004) ZRX1200C3H	
			2006) ZXR1200R-A6F		
			(02-03) VN1500P1H/P2H MAIN STREAK		
			(04-05) VN1600B1H/B2H MAIN STREAK		
			(92-95) ZR1100A-A4 ZEPHYR		
PPS-910	2 X PAD PIN 1 X PIN CLIP (3 PCS/SET)	SUZUKI		(93-96) RF600RP-T	
				1996) RF900RT	
				(95-04) GSF600S-K4 BANDIT	
				(96-00) GSF1200T-Y BANDIT	
				(01-05) GSF1200K1-K5 BANDIT	
				(98-03) GSX600FW-K3 KATANA	
				(98-03) GSX750FW-K3 KATANA	
				(98-01) GSX750W-K1 KATANA	
				(97-00) GSX-R600V-Y	
				(01-03) GSX-R600K1-K3	
				(94-95) GSX-R750WR/WS	
				(96-99) GSX-R750T-X	
				(00-03) GSX-R750Y-K3	
				(93-98) GSX-R1100WP-W	
				(99-01) GSX1200X-K1	
				(99-03) GSX1300RX-K3 HAYABUSA	
			(04-06) GSX1300RK4-K6		
			(97-01) TL1000SV-K1		
			(98-00) TL1000RW-Y		
		KAWA		(02-03) ZZR1200C1H/C2H ZX1200	
	(00-01) ZX1200A1H/A2H ZX-12R				
	(02-03) ZX1200B1H-B4H ZX-12R				
	2006) ZX1200B6F				
		(96-02) ZX750P1-P7 ZX-7			
PPS-911	2 X PAD PIN (2 PCS/SET)	SUZUKI	(04-05) GSX-R600K4/K5		
			(04-06) GSX-R750K4/K5		
			(03-04) GSX-R1000K3/K4		
		KAWA	2003) ZX600K1H		
			2004) ZX600M1H		
			2005) ZX600N1H		
			(03-04) ZX636B1H/B2H		
			2005) ZX636C1H		
			2006) ZX636C6F		
			(04-05) ZX1000C1H/C2H		
(04-05) ZX1200B3H/B4H					
2006) ZX1200B6F					
PPS-912	1 X PAD PIN	SUZUKI	2006) GSR600K6	2006) GSR600K6	
			(02-03) GSX-R750K2/K3	2006) GSX-R600K6	
			(01-02) GSX-R1000K1/K2	(02-03) VL1500 K2/K3 INTRUDER LC	
		KAWA	(02-06) GSX1400K2-K6	(05-06) VL1500K5/K6 INTRUDER LC	
			(03-05) SV1000K3-K5		
			(04-05) ZZR600E12H/E13H ZX600		
	(02-03) ZZR1200C1H/C2H ZX1200				
	(04-05) VN2000				

MC ID	DETAILS		FRONT	REAR	
PPS-913	1 X PAD PIN 1 X PIN PLUG (2 PCS/SET)	HONDA	(92-93) CB250N/P NIGHT HAWK	(92-01) CB750F2N-F21 SEVEN FIFTY	
			(96-04) CB250T-4 TWO FIFTY	(98-99) CB600FW/FX	
			(91-92) CB750M/N NIGHT HAWK	(93-96) CB1000FP-FT	
			(94-96) CB500R-T	(91-98) CBR600FM-FW	
			(98-05) CB600FW-F5 HORNET	(90-92) CBR1000FL-FN	
			(02-05) CB900F2-F5 HORNET	(88-97) VFR750FJ-FV	
			(93-95) CB1000FP-FT	(98-05) VT1100C2	
			(04-05) CBF600N4/N5	(98-02) VT1100C3W-C32	
			(04-05) CBF600S4/S5	1999) VT1100D2X	
			(04-05) CBF600NA4/BA5	(03-05) VTX1300S3/S4/S5	
			(04-05) CBF600SA4/SA5	(96-99) XL600VT-VX TRANSALP	
			(96-98) CBR600FT/FV/FW	(00-05) XL650VY-V5 TRANSALP	
			(92-97) CBR900RRN-RRV	(98-00) XRV750W/X/Y AFRICA TWIN	
			(90-92) CBR1000FL-FN	(01-02) FJS600-1/2 SILVER WING	
			(93-02) VF750CP-C2	(03-05) FJS600A3/A4/A5 SILVER WING	
			(88-97) VFR750FJ-FV	(03-05) FJS600D3/D4/D5 SILVER WING	
			(93-99) VT600CP-CX		
			(94-99) VT600CDR-CDX		
			(97-05) VT750CV-C5		
			(97-01) VT750C2V-C21		
			(94-98) VT1100CR-CW		
			(95-05) VT1100C2		
			1999) VT1100D2		
			(90-02) ST1100L-2		
			(92-95) ST1100AN-AS		
			(97-05) VTR1000FV-F5 FIRE STORM		
			(03-05) VTX1300S3/S4/S5		
			(94-96) VL600VR-VT TRANSALP		
			1988) NTV600J		
			(88-97) NTV650J-V		
			SUZUKI	(95-98) GSF600S-W BANDIT	(03-06) SV650K3-K6
				(93-96) RF600RP-RT	(03-05) SV1000K3-K5
				(03-05) AN650K3-K5 BURGMAN	(05-06) GSF650AK5/AK6 BANDIT
				(02-03) GSX-R600K2/K3	(04-06) DL650K4-K6 V-STROM
				(02-06) DL1000K2-K6 V-STROM	
				(97-01) XF650V-K1 FREEWIND	
				(04-05) GSX-R600K4/K5	
				(04-05) GSX-R750K4/K5	
				(01-06) GSX-R1000K1-K6	
				(02-06) GSX1400K2-K6	
		KAWA	(96-97) ZX750N1/N2	(96-97) ZX750N1/N2	
			(98-99) FZS600 FAZER		
		YAMAHA	(00-01) FZS600S FAZER		
			2005) R46		
(96-99) YZF600R THUNDER CAT					
(00-02) YZF600R THUNDER CAT					
(99-02) YZF-R6					
(03-06) YZF-R6					
(99-00) YZF-R7 OWO2					
(02-05) TDM900					
2005) TDM900A					
2006) FZ1-N FZ1000					
(01-03) FZS1000 FAZER					
(04-05) FZS1000 FAZER					
(96-00) YZF1000R THUNDER ACE					
(98-01) YZF-R1					
(02-06) YZF-R1					
2006) YZF-R1S					
(02-04) BT1100 BULLDOG					
(05-06) BT1100 BULLDOG					
(03-05) FJR1300A					
(01-04) FJR1300					
(99-01) XJR1300SP					
(99-01) XJR1300					
(02-06) XJR1300					
PPS-914	1 X PAD PIN 2 X PIN CLIP (3 PCS/SET)				

CLUTCH REPAIR PARTS

CLUTCH FRICTION DISC SET

CHOOSE QUALITY !!



CF***/B**
Cork type material



CF***/P**
Paper type material



CHECK DETAILS
IN THE CONTENTS LIST

Paper type is more durable than Cork type
Approx. 40-50 %

CLUTCH PLATE SET

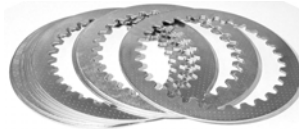

CLUTCH SPRING SET



H.D. SPRING
5-12 % STIFFER THAN STANDARD SPRING



CLUTCH MASTERCYLINDER REPAIR KIT



CLUTCH SLAVE CYLINDER REPAIR KIT

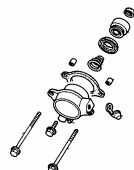

CLUTCH PARTS

remarks:

CLUTCH PLATE SET:

On the item marked (*),

You need to add Clutch plate B additionally. It is not included in set



MODEL	YEAR	FRICITION DISC SET	H.D SPRING SET	CLUTCH PLATE SET	MASTERCYLINDER REPAIR KIT	SLAVE CYLINDER REPAIR KIT
		HONDA				
CRF-50F	04-06	CDF-175				
CRF-70F	04-06	CDF-175				
MTX80RFd	83	CDF-141	HSP-117 4			
MTX80RSd	83	CDF-141	HSP-117 4			
MTX80C	83	CDF-141	HSP-117 4			
MBX80SWd	83	CDF-141	HSP-117 4			
MBX80SWDd	83	CDF-141	HSP-117 4			
MBX80FWd	83	CDF-141	HSP-117 4			
MBX80SW2d	83	CDF-141	HSP-117 4			
CR80R	85-86	CDF-136X	HSP-107 4	CPL-0026		
CR80R	86-96	CDF-136X	HSP-107 4	CPL-0029		
CR80RB	96	CDF-136X	HSP-107 4	CPL-0029		
CR80R	96-00	CDF-136X	HSP-107 4	CPL-0029		
CR80R	01-02	CDF-136X		CPL-0029		
CRF80F	09	CDF-156		CPL-0027		
XL80S	80-85	CDF-156		CPL-0027		
XR80R	85-86	CDF-156		CPL-0027		
XR80R	87-00	CDF-156	HSP-118 4	CPL-0027		
XR80R	01-03	CDF-156		CPL-0027		
CR85R3/RB3	03-04	CDF-136X	HSP-107 4	CPL-0029		
CR85R	05	CDF-179	HSP-107 4	CPL-0029		
CR85R	06-07	CDF-179		CPL-0030		
CRF100F	04-09	CDF-157		CPL-0028		
XR100R	85-86	CDF-141		CPL-0028		
XR100R	87-00	CDF-157		CPL-0028		
XR100R	01-02	CDF-157				
CBR125	04-06			CPL-0035		
CR125R	81	CDF-142		CPL-0036		
CR125R	82	CDF-137X				
CR125R	83-84	CDF-162		CPL-0037		
CR125R	85	CDF-168		CPL-0037		
CR125R	86-99	CDF-137X		CPL-0038		
				CPL-0024		
CR125R	00-03	CDF-138X	HSP-123 5	CPL-0039		
				CPL-0025		
CR125R	04-07	CDF-138X		CPL-0039		
NSR125F J/K/L/M/P	88-93	CDF-127				
NSR125R P/R/S/V	93-97	CDF-127				
XL125S	85	CDF-126		CPL-0029		
XL125V	01-05	CDF-180		CPL-0023		
XR125L	03-04	CDF-136X		CPL-0029		
CRF150R	08-09	CDF-185P	HSP-155	CPL-0154		
XL200R	83-84	CDF-126		CPL-0029		
XR200	80-84	CDF-126		CPL-0029		
XR200R	84-85	CDF-159		CPL-0040		
XR200R	86-02	CDF-126		CPL-0029		
CRF230F	09	CDF-192				
CB250 T1	78	CDF-111	HSP-113 4	CPL-0010 *		
CB250 T2	78	CDF-111	HSP-113 4	CPL-0010 *		
CB250N	79	CDF-111	HSP-113 4	CPL-0010 *		
CB250NA	80	CDF-111	HSP-113 4	CPL-0010 *		
CB250NDc	82	CDF-111	HSP-113 4	CPL-0010 *		
CB250 NIGHTHAWK	91-97	CDF-142				
CB250	00-08	CDF185P		CPL-0143		
CMX250C	09			CPL-0143		
CR250R	81-82	CDF-146		CPL-0034		
CR250R	83	CDF-160		CPL-0011		
CR250R	84-89	CDF-160		CPL-0031		
CR250R	90	CDF-161		CPL-0141		
CR250R	91-93	CDF-139X		CPL-0141		
CR250R	94-07	CDF-139X	HSP-124 6	CPL-0032		

MODEL	YEAR	FRICION DISC SET	H.D SPRING SET	CLUTCH PLATE SET	MASTERCYLINDER REPAIR KIT	SLAVE CYLINDER REPAIR KIT
CRF250R	04-05	CDF-178		CPL-0043		
CRF250R	06-07	CDF-178		CPL-0043		
CRF250R	08-09	CDF-186P	HSP-154 5	CPL-0043		
CRF250R	10	CDF-178	HSP-154 5	CPL-0043		
CMX250C/CD	85-86	CDF-142				
CMX250C	87	CDF-142		CPL-0143		
XL250R	81-83	CDF-163		CPL-0023		
XL250R	84-87	CDF-159		CPL-0040		
XL250S	78-80	CDF-165		CPL-0022		
XR250L	91-95	CDF-162		CPL-0041		
XR250R	84-85	CDF-159		CPL-0040		
XR250R	86-95	CDF-162		CPL-0041		
XR250R	96-04	CDF-162	HSP-148 4	CPL-0041		
CB350F/F1	73-74	CDF-111	HSP-105 4	CPL-0024		
CB350G/K5		CDF-143				
XR350R	83-84	CDF-162		CPL-0041		
XR350R	85	CDF-162		CPL-0041		
CB400 T1	78	CDF-111	HSP-114 4	CPL-0010 *		
CB400 T2	79	CDF-111	HSP-114 4	CPL-0010 *		
CB400N	79	CDF-111	HSP-114 4	CPL-0010 *		
CB400NDc	82	CDF-111	HSP-114 4	CPL-0010 *		
CB400TZ 1		CDF-111	HSP-114 4	CPL-0010 *		
CB400TZ 2		CDF-111	HSP-114 4	CPL-0010 *		
CM400E	80-81	CDF-111	HSP-114 4	CPL-0010 *		
CM400T Z/A/B	79-81	CDF-111	HSP-114 4			
XR400R	96-04	CDF-136P	HSP-112 5	CPL-0042		
CB450 HAWK	82	CDF-111	HSP-114 4	CPL-0010 *		
CB450SC	82-86	CDF-111		CPL-0010 *		
CRF450	02-03	CDF-173P	HSP-124 6	CPL-0033		
CRF450R	04-07	CDF-174		CPL-0033		
CRF450R	08	CDF-173P	HSP-124 6	CPL-0033		
CRF450R	09-10	CDF-173P		CPL-0033		
CB500K/K1/K2		CDF-144				
CB500T/76 TWIN DOHC		CDF-145		CPL-0002		
CB500 T-Y	96-00	CDF-155PM	HSP-112 4			
CB500S W-Y	98-00	CDF-155PM	HSP-112 4			
CBF500	04-06	CDF-155PM				
CR500R	84-89	CDF-160		CPL-0031		
CR500R	90	CDF-161		CPL-0141		
CR500R	91-01	CDF-139X		CPL-0141		
CX500 A/B	80-81	CDF-102	HSP-103 4	CPL-0006 *		
CX500C C	82	CDF-102	HSP-105 6	CPL-0006 *		
CX500CA/CB/DA	80-81	CDF-102	HSP-105 6	CPL-0006 *		
FT500C	82	CDF-116	HSP-115 4			
GL500 SILVERWING	81-82	CDF-102	HSP-104 6	CPL-0006 *		
GL500I INTERSTATE	81-82	CDF-102	HSP-103 4	CPL-0006 *		
VF500C	84-85			CPL-0049	MSC-101	CCK-103
VF500F	84-85			CPL-0049	MSC-101	CCK-103
VT500Ed	83	CDF-127	HSP-113 4			
XL500R	82	CDF-111	HSP-115 4	CPL-0012		
XL500S	79-81	CDF-111	HSP-115 4	CPL-0012		
XR500	79-82	CDF-116	HSP-115 4	CPL-0012		
XR500R	83-84	CDF-117		CPL-0011		
CB550K/K1		CDF-146		CPL-0017		
CB550SC NIGHTHAWK	83			CPL-0016	MSC-101	CCK-101
CB550F	76	CDF-102	HSP-101 4			
CBX550FC	82	CDF-128		CPL-0016	MSC-101	
CBR600F (2020219->	87	CDF-112PP	HSP-116 4			
CB600F W/X/Y	98-00	CDF-110P	HSP-122 4	CPL-0014		
CB600F HORNET	01-06	CDF-110PP	HSP-122 4	CPL-0014		
CB600F	07-10	CDF-135PM		CPL-0048		
CB600F3	09-10	CDF-135PM		CPL-0048		
CB600FA	09-10	CDF-135PM		CPL-0048		
CBF600N/NA	04-06	CDF-110PP	HSP-122 4	CPL-0014		
CBF600N/NA	07-09	CDF-135PM		CPL-0048		
CBF600S	04-06	CDF-110PP	HSP-122 4	CPL-0014		
CBF600S/SA	08-09	CDF-135PM		CPL-0048		
CBR600F(2000856-2020218)	87	CDF-112	HSP-116 4	CPL-0016		
CBR600F(2020219->	87	CDF-112PP	HSP-116 4	CPL-0016		
CBR600F(TO 2109928	88	CDF-112PP	HSP-116 4	CPL-0016		

MODEL	YEAR	FRICITION DISC SET	H.D SPRING SET	CLUTCH PLATE SET	MASTERCYLINDER REPAIR KIT	SLAVE CYLINDER REPAIR KIT
CBR600F(2109929-2113253)	88	CDF-112PP	HSP-116 4	CPL-0016		
CBR600F (2113254->	88-89	CDF-112PP	HSP-116 4	CPL-0016		
CBR600F (M)	91-94	CDF-110P	HSP-122 4	CPL-0014		
CBR600F (S/T)	95-98	CDF-110PP		CPL-0014		
CBR600F	99-06	CDF-136PM		CPL-0013		
CBR600F4	99-00	CDF-136PM		CPL-0013		
CBR600F4	01-04	CDF-135PM		CPL-0048		
CBR600FR	02	CDF-135PM		CPL-0048		
CBR600FS	01-02	CDF-135PM		CPL-0048		
CBR600RR	03	CDF-135PM	HSP-150 5	CPL-0048		
CBR600RR	04-06	CDF-135PM	HSP-150 5	CPL-0048		
CBR600RR	07-10	CDF-135PM		CPL-0048		
CBR600RA	09-10	CDF-135PM		CPL-0048		
VT600C	88	CDF-109	HSP-112 4	CPL-0010		
VT600C	91-02	CDF-109	HSP-112 4	CPL-0010		
VT600C	03-04	CDF-123P	HSP-112 4	CPL-0010		
VT600CD	95-02	CDF-109	HSP-112 4	CPL-0010		
VT600CD	03-04	CDF-123P	HSP-112 4			
XL600Ld/Rd	83	CDF-117		CPL-0011		
XL600R	84-87	CDF-117		CPL-0011		
XL600V	89-90	CDF-109	HSP-112 4	CPL-0010		
XL600V	91-99	CDF-109	HSP-112 6	CPL-0010		
XR600R	93-00	CDF-117		CPL-0011		
XR650R	07	CDF-172P		CPL-0011		
CB650	79-82	CDF-101	HSP-101 4	CPL-0005		
CB650C	80-81	CDF-101	HSP-103 4	CPL-0005		
CB650SC	82	CDF-101	HSP-104 6	CPL-0005		
CB650SC NIGHTHAWK	83-85	CDF-130	HSP-105 5	CPL-0016	MSC-101	CCK-101
CB650SCd	83	CDF-130				
CX650C	83	CDF-101	HSP-102 4	CPL-0007 *		
CX650ED	83	CDF-101	HSP-104 6	CPL-0007 *	MSC-101	CCK-101
CBX650Ed	83	CDF-130	HSP-105 5			
GL650	83	CDF-101	HSP-103 4	CPL-0007 *		
NTV650j	88	CDF-129	HSP-119 4	CPL-0025		
NT650 HAWK GT	88-89	CDF-129		CPL-0025		
NT650 HAWK GT	90-91	CDF-129				
NT650V	98-01	CDF-182		CPL-0045		
NTV650V	02-05	CDF-119		CPL-0045		
XL650V	01-06	CDF-119		CPL-0045		
XR650L	93-09	CDF-140		CPL-0011		
XRV650j	88	CDF-129	HSP-119 4	CPL-0025		
XR650R Y/1	00-04	CDF-172P		CPL-0011		
XR650R	05-06	CDF-172P		CPL-0011		
NX650 J/K/L	88-90	CDF-117		CPL-0011		
NX650	92-94	CDF-117		CPL-0011		
NT700V	06-10			CPL-0025		
CB750K1-K5	71-75	CDF-177		CPL-0002 *		
CB750K	76	CDF-115		CPL-0002		
CB750F	77-78	CDF-115		CPL-0001 *		
CB750L	79	CDF-103	HSP-104 6			
CB750K Z/A/B	79-81	CDF-103	HSP-104 6	CPL-0004 *		
CB750FZ	79	CDF-103	HSP-104 6	CPL-0004 *		
CB750FA/FB/FC	80-82	CDF-103	HSP-104 6	CPL-0004 *		
CB750C	80-82	CDF-103	HSP-104 6	CPL-0004 *		
CB750F2C	82	CDF-103	HSP-104 6	CPL-0004 *		
CB750SC	82-83	CDF-103	HSP-104 6	CPL-0004 *		
CB750 M/N/S	91-95	CDF-149	HSP-116 4	CPL-0016		
CB750F2 N/R/S	92-95	CDF-149		CPL-0016		
CB750F2 V/W/X/Y/1	97-01	CDF-149		CPL-0017		
CBX750Fe	84	CDF-108		CPL-0001	MSC-101	
VF750C C/D	82-83	CDF-108	HSP-105 6	CPL-0001	MSC-101	CCK-101
VF750C E	84	CDF-108	HSP-105 6	CPL-0001	MSC-101	CCK-101
VF750C	88	CDF-108	HSP-105 5	CPL-0001	MSC-101	CCK-101
VF750C	98-00	CDF-118		CPL-0014		
VF750CD/C2	95-97	CDF-118		CPL-0014		
VF750C2	98-00	CDF-118		CPL-0014		
VF750F	83-85	CDF-113	-	CPL-0002	MSC-101	CCK-101
VF750S C/D SABRE	82-83	CDF-108	HSP-105 6	CPL-0001	MSC-101	CCK-101
VFR750F	88-95	CDF-118		CPL-0014	MSC-101	CCK-103

MODEL	YEAR	FRICION DISC SET	H.D SPRING SET	CLUTCH PLATE SET	MASTERCYLINDER REPAIR KIT	SLAVE CYLINDER REPAIR KIT
VFR750F2	86-87				MSC-101	CCK-103
VFR750R	88	CDF-131		CPL-0015	MSC-101	CCK-103
VFR750R RC30	90				MSC-101	CCK-103
VT750C D	83	CDF-108	-	CPL-0001	MSC-101	CCK-101
VT750C E/F	84-85	CDF-108	-	CPL-0001	MSC-101	
VT750C	97-01	CDF-119	HSP-119 4	CPL-0045		
VT750C	05-09	CDF-119		CPL-0045		
VT750CA	09	CDF-119		CPL-0045		
VT750C2	97-01	CDF-119	HSP-119 4	CPL-0045		
VT750C3	01	CDF-119	HSP-119 4			
VT750CD	98-99	CDF-119	HSP-119 4			
VT750CD2	98-99	CDF-119	HSP-119 4			
VT750CD3	01	CDF-119	HSP-119 4			
VT750DC	01-02	CDF-119	HSP-119 4	CPL-0045		
VT750DCA	03	CDF-119	HSP-119 4	CPL-0045		
XRV750 P-Y	93-00	CDF-113		CPL-0044		
PC800	89-90	CDF-113		CPL-0052	MSC-101	CCK-101
VFR800FI	98-99	CDF-118		CPL-0014	MSC-101	CCK-105
VFR800FI	00-01	CDF-137PM		CPL-0048	MSC-103	CCK-105
VFR800	02-06	CDF-135PM		CPL-0048	MSC-103	CCK-104
VFR800	09	CDF-135PM		CPL-0048		
VFR800A	02-06	CDF-135PM		CPL-0048	MSC-103	CCK-104
VFR800A	08-09	CDF-135PM		CPL-0048		
VT800C	88	CDF-108		CPL-0001	MSC-101	CCK-101
CB900FZ/FA/FB/FC	79-82	CDF-103	HSP-105 6	CPL-0004 *		
CB900F2B/F2C	81-82	CDF-103	HSP-105 6	CPL-0004 *		
CB900F HORNET	02-03	CDF-135PM		CPL-0048		
CB900F	07	CDF-135PM		CPL-0048		
CB1000R	09	CDF-183	HSP-149 5	CPL-0148		
CBR900RR N/P	92-95	CDF-110PP	HSP-119 5	CPL-0046		
CBR900RR	98-99	CDF-135PM		CPL-0048	MSC-103	CCK-104
CBR900RR	00-03	CDF-171P		CPL-0046		
CBF1000	06-07	CDF-183	HSP-149 5	CPL-0148	MSC-103	
CBF1000	08-10	CDF-183	HSP-149 5	CPL-0148		
CBF1000A	06-07	CDF-183	HSP-149 5	CPL-0148	MSC-103	
CBF1000A	08-10	CDF-183	HSP-149 5	CPL-0148		
CBF1000S	07-10	CDF-183	HSP-149 5	CPL-0148		
CBF1000T	07-10	CDF-183	HSP-149 5	CPL-0148		
CBR1000F	87-95	CDF-132		CPL-0018	MSC-101	CCK-103
CBR1000RR	04-07	CDF-183	HSP-152 5	CPL-0148	MSC-103	
CBX Z-C	79-82	CDF-133	HSP-105 6			
CB1000F P/R/S	93-95	CDF-132		CPL-0018		
CB1000C	83	CDF-103		CPL-0004 *		
GL1000K3/Z	78-79	CDF-105	HSP-105 6	CPL-0002 *		
RVT1000R	00-01	CDF-139P		CPL-0066		
RVT1000R	02-03	CDF-176P		CPL-0066		
VF1000F	84-86	CDF-114	-	CPL-0003	MSC-101	CCK-102
VF1000F2F/F2G	85-86	CDF-114	-	CPL-0003	MSC-101	CCK-102
VF1000R	85-86	CDF-114	-	CPL-0003	MSC-101	CCK-102
VTR1000F	97-06	CDF-120P	HSP-120 5	CPL-0019	MSC-101	CCK-105
VTR1000SP	00-01	CDF-139P		CPL-0066	MSC-103	CCK-105
VTR1000SP	02-06	CDF-176P		CPL-0066	MSC-103	CCK-105
XL1000V	99-02	CDF-120P	HSP-120 5	CPL-0019		
XL1000V	03-05	CDF-181P		CPL-0021		
XL1000V	06-09	CDF-181P				
CB1100RB/RC	81-82	CDF-103	HSP-105 6	CPL-0004 *		
CB1100SF Y	00	CDF-139P		CPL-0066	MSC-101	CCK-105
CBR1100XX	97-98	CDF-122P	HSP-121 5	CPL-0145	MSC-101	CCK-105
CBR1100XX	99-03	CDF-139P		CPL-0066	MSC-103	CCK-105
CBR1100XX	04-06	CDF-139P		CPL-0066	MSC-103	CCK-105
GL1100A/IA/DA	80	CDF-106	HSP-105 6	CPL-0009		
GL1100B/IB/DB	81	CDF-106	HSP-105 6	CPL-0009		
GL1100C/IC/DC/AC	82	CDF-106	HSP-105 6	CPL-0009		
GL1100D/ID/DD	83	CDF-106	HSP-105 6	CPL-0009		
VT1100C	85-86	CDF-108PP		CPL-0001		
VT1100C	87-91	CDF-108PP		CPL-0001		
VT1100C	92-96	CDF-108PP		CPL-0001		
VT1100C	97-04	CDF-124P		CPL-0018		
VT1100C2	95-97	CDF-124P		CPL-0018		
VT1100C2	98-03	CDF-124P		CPL-0018		
VT1100C2	04-05	CDF-124P		CPL-0018		
VT1100C3	98-00	CDF-124P		CPL-0018		
VT1100D2	99	CDF-124P		CPL-0018		
VT1100T	98-00	CDF-124P		CPL-0018		

MODEL	YEAR	FRICION DISC SET	H.D SPRING SET	CLUTCH PLATE SET	MASTERCYLINDER REPAIR KIT	SLAVE CYLINDER REPAIR KIT
ST1100	92-02	CDF-138		CPL-0019	MSC-101	CCK-103
ST1100	03	CDF-169P		CPL-0050		
ST1100A	95-02	CDF-138		CPL-0019	MSC-101	CCK-103
ST1100A	03	CDF-169P		CPL-0050		
GL1200E/DE/IE/AE	84	CDF-107		CPL-0008	MSC-102	CCK-102
GL1200I/A	84-85	CDF-107		CPL-0008	MSC-102	CCK-102
GL1200L	85	CDF-107		CPL-0008		CCK-102
CB1300F1	03	CDF-181P	HSP-153 6	CPL-0021		
CB1300F	03	CDF-181P	HSP-153 6	CPL-0021		
CB1300	05	CDF-181P	HSP-153 6	CPL-0021		
CB1300	06-09	CDF-181P	HSP-153 6	CPL-0021		
CB1300A	05-09	CDF-181P	HSP-153 6	CPL-0021		
CB1300S	05-09	CDF-181P	HSP-153 6	CPL-0021		
CB1300SA	05-09	CDF-181P	HSP-153 6	CPL-0021		
ST1300	02-06	CDF-169P	HSP-151 6	CPL-0050		CCK-105
ST1300	07-09	CDF-169P	HSP-151 6	CPL-0050		
ST1300A	02-08	CDF-169P	HSP-151 6	CPL-0050		CCK-105
ST1300A	09	CDF-169P	HSP-151 6	CPL-0050		
VTX1300S	03-07	CDF-170P	HSP-149 5	CPL-0050		
VTX1300C	04	CDF-170P		CPL-0050		
VTX1300C	08-09	CDF-170P	HSP-149 6	CPL-0050		
VTX1300R	09	CDF-170P	HSP-149 6	CPL-0050		
GL1500	88-89	CDF-104		CPL-0051 *	MSC-102	CCK-103
GL1500A	90-96	CDF-104PP		CPL-0051 *	MSC-102	CCK-103
GL1500A	97-98	CDF-125P		CPL-0051 *	MSC-102	CCK-103
GL1500A	99-00	CDF-125PP		CPL-0051 *	MSC-102	CCK-103
GL1500C	97-98	CDF-125P		CPL-0051 *	MSC-102	CCK-103
GL1500C	99-03	CDF-125PP		CPL-0051 *	MSC-102	CCK-103
GL1500CD	01-03	CDF-125PP		CPL-0051 *	MSC-102	CCK-103
GL1500CF	99-00	CDF-125PP				CCK-103
GL1500CT	97-98	CDF-125P		CPL-0051 *	MSC-102	CCK-103
GL1500I	91-96	CDF-104PP				CCK-103
GL1500SE	90-96	CDF-104PP		CPL-0051	MSC-102	CCK-103
GL1500SE	97-98	CDF-125P		CPL-0051	MSC-102	CCK-103
GL1500SE	99-00	CDF-125PP		CPL-0051	MSC-102	CCK-103
GL1800A	01-03	CDF-169P		CPL-0067		
GL1800A	04-05	CDF-184P		CPL-0067		
GL1800	01-04	CDF-169P		CPL-0067		
GL1800	06	CDF-184P		CPL-0067		
VTX1800C	02-04	CDF-170P	HSP-149 6	CPL-0067	MSC-103	CCK-103
VTX1800C1	05-06	CDF-170P	HSP-149 6	CPL-0067		
		YAMAHA				
RD50M	80-82	CDF-252				
DT50MX	82	CDF-252				
DT50M	80	CDF-252				
TY50M	80	CDF-252				
RD80MX	82	CDF-253				
DT80MX	82	CDF-253				
DT80MXS	84	CDF-254				
DT80LC	85	CDF-254				
YZ80	84-85	CDF-259				
YZ80	86-92	CDF-240				
YZ80	93-94	CDF-260				
YZ80	95-01	CDF-261				
YZ85	02-10	CDF-281				
YZ85LW	02-07	CDF-281				
TTR90	00-06	CDF-262				
TTR90P	02	CDF-262				
TTR90R	03	CDF-262				
DT125LC	82	CDF-240				
DT125R	95-00	CDF-230				
RD125LC	82	CDF-255				
TDR125	96-99	CDF-230				
TZR125	95-97	CDF-230				
TTR125	01-05	CDF-263				
TTR125E	06-10	CDF-263				
TTR-125LE	06-10	CDF-263				
TTR125L	06	CDF-263				
TW125	99-01	CDF-283				
TW125	02-03	CDF-284				
XV125	97-99	CDF-229	HSP-207 4			
XV125	00	CDF-257	HSP-207 4			
XV125S	97-99	CDF-229	HSP-207 4			

MODEL	YEAR	FRICION DISC SET	H.D SPRING SET	CLUTCH PLATE SET	MASTERCYLIN DER REPAIR KIT	SLAVE CYLINDER REPAIR KIT
XVS125	00	CDF-257	HSP-207 4			
XVS125	01-02	CDF-279	HSP-207 4			
YZ125	86-87	CDF-264				
YZ125	88	CDF-265				
YZ125	89-90	CDF-266				
YZ125	91-92	CDF-267	HSP-205 5			
YZ125	93-97	CDF-241X	HSP-205 5			
YZ125	98	CDF-268	HSP-205 5			
YZ125	00-04	CDF-269	HSP-205 5			
YZ125	05-010	CDF-241X	HSP-205 5			
TW200	06-09	CDF-284				
TTR225	04	CDF-289				
XT225	01-06	CDF-274				
TTR230	09	CDF-289				
RD250LC	82	CDF-237				
TDR250	88	CDF-250	HSP-212 4			
TZR250	88	CDF-250	HSP-212 4			
TTR250	01-06	CDF-267	HSP-205 5			
WR250Z	92-93	CDF-270	HSP-205 6			
WR250Z	94-97	CDF-242X	HSP-205 6			
WR250F	01	CDF-271	HSP-215 5			
WR250F	02-10	CDF-271				
WR250R	09	CDF-267	HSP-205 5			
WR250X	09	CDF-267	HSP-205 5			
WR250FP	02	CDF-271				
XT250	82	CDF-239				
XT250	09-10	CDF-2A6	HSP-205 5			
XV250	95-10	CDF-229	HSP-207 4			
XV250S	95-99	CDF-229	HSP-207 4			
YZ250	83-87	CDF-272				
YZ250	88-90	CDF-225	HSP-205 6			
YZ250	91-92	CDF-270	HSP-205 6			
YZ250	93-98	CDF-242X	HSP-205 6			
YZ250	99	CDF-242X				
YZ250	00-01	CDF-242X				
YZ250	02-10	CDF-242X	HSP-218 6			
YZ250F	01-07	CDF-271	HSP-202 5			
YZ250F	08-10	CDF-294P	HSP-222 5			
RD350LC	82	CDF-237				
RD350	85	CDF-237				
XT350H/N	88	CDF-237	HSP-205 5			
XT350	90-98	CDF-237	HSP-205 5			
XS360 C/D	76-77	CDF-206	HSP-207 4			
WR400F	98-00	CDF-273	HSP-211 5			
WR400F	01-02	CDF-278P	HSP-211 5			
XS400 D/E/F/2F/G	77-80	CDF-206	HSP-207 4			
XS400 G/SG/H/SH	80-81	CDF-206	HSP-207 4			
XS400 J/K MAXIM	82-83	CDF-213	HSP-207 6			
XS400 SE <4G5>	82	CDF-206	HSP-207 4			
XS400 SJ HERITAGE	82	CDF-206	HSP-207 4			
XS400 SPECIAL II	80	CDF-206	HSP-207 4			
XS400RJ/RK SECA	82-83	CDF-213	HSP-207 6			
YZ400F	98-99	CDF-273				
YZ426F	00	CDF-292P	HSP-218 6			
YZ426F	01	CDF-282	HSP-218 6			
WR426F	01-02	CDF-242X				
WR426FP	01-02	CDF-242X				
WR450F	03	CDF-285P				
WR450F	04	CDF-280				
WR450F	05-10	CDF-288	HSP-218 6			
WR450FR	03	CDF-285P				
YZ450F	03-04	CDF-280	HSP-218 6			
YZ450F	05-06	CDF-280	HSP-218 6			
YZF450F	07-10	CDF-288	HSP-210 6			
SR500	82-88	CDF-234	HSP-205 6			
WR500Z	92-93	CDF-272				
XT500 E/F/G/H	78-88	CDF-234	HSP-205 6			
XV500	83	CDF-203	HSP-203 5			
XV535	87-99	CDF-203	HSP-203 5			
XV535	01	CDF-203	HSP-203 5			
XV535SE	88	CDF-203	HSP-203 5			
XV535S	94-97	CDF-203	HSP-203 5			
XZ550	82	CDF-234	HSP-205 5			
XT550	82	CDF-235	HSP-208 5			

MODEL	YEAR	FRICION DISC SET	H.D SPRING SET	CLUTCH PLATE SET	MASTERCYLINDER REPAIR KIT	SLAVE CYLINDER REPAIR KIT
XZ550	82	CDF-234	HSP-205 5			
XJ550	83	CDF-251	HSP-205 5			
SRX600	86	CDF-224	HSP-208 5			
FZR600 W/A/B	89-91	CDF-201	HSP-201 5			
FZR600R	92-98	CDF-201	HSP-201 5			
FZR600R <4JH1/3,4MH/1>	94	CDF-202P	HSP-202 6			
FZR600R <4JH4/6,4MH2>	95	CDF-202P	HSP-202 6			
TT600R	99	CDF-224	HSP-207 5			
YZF600 RH/RJ/RK	96-98	CDF-202P	HSP-202 6			
YZF600R	97-06	CDF-228P				
YZF-R6	99-02	CDF-226P	HSP-209 6			
YZF-R6	03-05	CDF-226P	HSP-218 6			
YZF-R6	06-10	CDF-208P	HSP-219 6			
YZF-R6S	01-02	CDF-226P	HSP-209 6			
YZF-R6S	08-09	CDF-226P	HSP-218 6			
FZS600	98-99	CDF-227				
FZS600	00-03	CDF-256	HSP-215 6			
FZS600	00-02	CDF-256	HSP-215 6			
FZS600R	03	CDF-256	HSP-215 6			
FZS600S	01-02	CDF-256	HSP-215 6			
FZ600S	04-05	CDF-290P				
FZ6	04-07	CDF-290P	HSP-209 6			
FZ6 FAZER	04-07	CDF-290P	HSP-209 6			
FZ6-NS	05-06	CDF-290P	HSP-209 6			
FZ6 S2	07-08	CDF-290P	HSP-209 6			
FZ6 S2 FAZER	07-08	CDF-290P	HSP-209 6			
FZ6 S2 FAZER ABS	08	CDF-290P	HSP-209 6			
FZ6 <RYL>	09	CDF-2A2	HSP-209 6			
FZ6 <RYCB>	09	CDF-2A2	HSP-209 6			
FZS600SN	01	CDF-256	HSP-215 6			
TT600R	00-01	CDF-224	HSP-207 5			
TT600R	02	CDF-224				
TT600RE	04	CDF-224				
XJ600	84	CDF-207	HSP-205 5			
XJ600N	95-02	CDF-207	HSP-205 5			
XJ600S	92-99	CDF-207	HSP-205 5			
XJ6-N	09-10	CDF-2A2	HSP-209 6			
XJ6-D DIVERSION	10	CDF-2A2	HSP-209 6			
XJ6-S DIVERSION	09-10	CDF-2A2	HSP-209 6			
XT600Z	84	CDF-224	HSP-207 5			
XT600Z	86-88	CDF-224	HSP-208 5			
XT600Z	90	CDF-224	HSP-208 6			
XT600 H/N	87	CDF-224	HSP-207 5			
XT600E	90-02	CDF-224	HSP-208 5			
XJ650 G/H MAXIM	80-81	CDF-207	HSP-205 5			
XJ650LH M. SP	81	CDF-207	HSP-205 5			
XJ650 J MAXIM	82	CDF-207	HSP-205 5			
XJ650RJ SECA	82	CDF-207	HSP-205 5			
TURBO	82-83	CDF-207				
XJ650K MAXIM	83	CDF-207	HSP-205 5			
XJ650	83	CDF-207	HSP-205 5			
XS650 <1U3>	80	CDF-214	HSP-208 6			
XS650 G/H/SH/SJ SPECIAL II	80-82	CDF-214	HSP-208 6			
XS650 SK HERITAGE SPEICIAL	83	CDF-214	HSP-208 6			
XVS650	97-06	CDF-225	HSP-203 5			
XVS650A	98-05	CDF-225	HSP-203 5			
XVS65	04-09	CDF-225	HSP-203 5			
XVS65A V-STAR	04-09	CDF-225	HSP-203 5			
XVS65AT V-STAR	04-09	CDF-225	HSP-203 5			
XTZ660 H/N	92		HSP-208 5			
XTZ660 H/N	93	CDF-224	HSP-208 5			
XT660Z TENERE	08-09	CDF-2A9				
XT660X	04-10	CDF-2A9				
XT660R	04-10	CDF-2A9				
MT-03	06-09	CDF-2A9				
SZR660	95-97	CDF-224	HSP-208 5			
XJ750K MAXIM	83	CDF-207	HSP-205 5			
XJ750MK	83	CDF-207	HSP-205 5			
XJ750RH SECA	81	CDF-207	HSP-205 5			
XJ750RJ/RK SECA	82-83	CDF-207	HSP-205 5			

MODEL	YEAR	FRICION DISC SET	H.D SPRING SET	CLUTCH PLATE SET	MASTERCYLINDER REPAIR KIT	SLAVE CYLINDER REPAIR KIT
XS750	77	CDF-206	HSP-208 6			
XS750 E/F/SF/SE/	78-79	CDF-206	HSP-208 6			
XS750 SE <3L3>	80	CDF-206	HSP-208 6			
XV750H/K/K VIRAGO	81-83	CDF-204	HSP-205 6			
XV750SE	82	CDF-204	HSP-205 6			
XV750 MK VIRAGO	83	CDF-204	HSP-205 6			
XV750 VIRAGO	88-92	CDF-204	HSP-205 6			
XV750 VIRAGO	93-96	CDF-204	HSP-205 6			
XV750 J1VIRAGO	97	CDF-204	HSP-205 6			
FZ750	85-86	CDF-207	HSP-209 6		MSC-201	CCK-201
FZ750R	87-88	CDF-251	HSP-209 6		MSC-201	
FZR750R	87-88	CDF-209	HSP-209 6		MSC-201	CCK-201
YZF750 RF/RG	94-95	CDF-208P			MSC-202	CCK-201
YZF750 RH	96	CDF-208P	HSP-209 6		MSC-202	CCK-201
YZF750 RJ	97	CDF-208P	HSP-209 6			
YZF-R7	99	CDF-277P				
XTZ750	90	CDF-207				
TDM850H	91-93	CDF-207	HSP-209 6			
TDM850N	91-93	CDF-207	HSP-209 6			
TDM850	94-95	CDF-207	HSP-209 6			
TDM850	96-97	CDF-222	HSP-209 6			
TDM850	98		HSP-209 6			
TDM-850	99-01	CDF-286	HSP-218 6			
TRX850	96	CDF-222	HSP-209 6			
TDM900	03-10	CDF-286	HSP-210 6			
XJ900	83	CDF-207				
XJ900	85	CDF-207				
XJ900S	95-02	CDF-207				
XJ900SP	02	CDF-207				
XV920J VIRAGO	82	CDF-204	HSP-205 6			
XV920RJ VIRAGO	82	CDF-204	HSP-205 6			
XV920 K VIRAGO	83	CDF-204	HSP-205 6			
XV920 MK VIRAGO	83	CDF-204	HSP-205 6			
XVS950	09-10	CDF-2A5				
FZR1000 T/U	87-88	CDF-209	HSP-209 6		MSC-201	CCK-201
FZR1000	89-92		HSP-210 6		MSC-202	CCK-201
FZR1000 E/F/G	93-95		HSP-210 6		MSC-202	CCK-201
FZS1000	01-05		HSP-210 6			
FZS1000S	03		HSP-210 6			
FZ1	06-09	CDF-291P	HSP-220 6			
FZ1 FAZER	06-10	CDF-291P	HSP-220 6			
FZ1 FAZER ABS	07-08	CDF-291P	HSP-220 6			
YZF1000R	96-01		HSP-210 6		MSC-202	
GTS1000	93-94		HSP-210 6		MSC-202	CCK-201
YZF-R1	98	CDF-217				
YZF-R1	99-03	CDF-221				
YZF-R1	04-05	CDF-291P	HSP-220 6			
YZF-R1	06	CDF-291P	HSP-220 6			
YZF-R1	07-08	CDF-291P	HSP-221 6			
YZF-R1	09	CDF-2A4	HSP-221 6			
YZF-R1	09-10	CDF-2A4				
YZF-R1 SP	06	CDF-291P	HSP-221 6			
XV1000 <19T>	82	CDF-204	HSP-205 6			
XV1000SE	83	CDF-204	HSP-205 6			
XV1000 L/N VIRAGO	84-85	CDF-204	HSP-205 6			
BT1100	03-05	CDF-204				
XV1100 VIRAGO	86-97	CDF-204				
XVS1100	99-06	CDF-204				
XVS1100A	03-04	CDF-204				
XVS11AT	06-09	CDF-204				
XVS11AW	06-09	CDF-204				
XVS11	08-09	CDF-204				
XS1100	80	CDF-232	HSP-208 6			
FJ1100	84-85	CDF-231				CCK-201
FJ1200	86-92	CDF-231			MSC-201	CCK-201
FJ1200A	92-93	CDF-231			MSC-201	CCK-201
VMX12 V-MAX	85-05	CDF-205			MSC-201	CCK-201
VMX12 V-MAX	06	CDF-205				
XJ1200	95	CDF-219			MSC-202	
XJR1200	95-98	CDF-219				
XJR1200SP	96-98	CDF-219				
XVZ12 TD	83	CDF-205	HSP-206 6		MSC-201	CCK-201
XVZ12 D	84-85	CDF-205	HSP-206 6		MSC-201	CCK-201
FJR1300A	03	CDF-287				

MODEL	YEAR	FRICTION DISC SET	H.D SPRING SET	CLUTCH PLATE SET	MASTERCYLINDER REPAIR KIT	SLAVE CYLINDER REPAIR KIT
FJR1300	04-05	CDF-287				
FJR1300A	05	CDF-287				
FJR1300	08-10	CDF-287				
XJR1300	99-01	CDF-219			MSC-202	
XJR1300	02-03	CDF-219				
XJR1300	04-10	CDF-2A8				
XJR1300SP	99	CDF-219			MSC-202	
XJR1300M	01	CDF-219			MSC-202	
XJR1300N	01	CDF-219				
XJR1300R	03	CDF-219				
XVS13A V-STAR	08-09	CDF-287				
XVS13A	09	CDF-287				
XVS13CT	09	CDF-287				
XVZ13CT	06	CDF-205				
XVZ13 CT	08	CDF-218				
XVZ13CTM	06	CDF-205				
XVZ13D	86-93	CDF-205			MSC-201	CCK-201
XVZ13A/AT	96-97	CDF-205			MSC-202	CCK-201
XVZ13LT	97-01	CDF-205			MSC-202	CCK-201
XVZ13TF	00-05	CDF-205			MSC-202	CCK-201
XVZ13TF	06	CDF-205				
XVZ13TFM	05	CDF-205			MSC-202	CCK-201
XVZ13TFM	06	CDF-205				
XV13CT ROYAL STAR TOUR DELUXE	09	CDF-205				
XV13CTS ROYAL STAR TOUR DELUXE	09-10	CDF-205				
XV13TF ROYAL STAR VENTURE	09	CDF-205				
XV13TFS ROYAL STAR VENTURE S	09	CDF-205				
XVZ1300A	00	CDF-205				
XV1600A	99-01	CDF-216				
XV1600A	02	CDF-276				
XV1600AL	00	CDF-216				
XV1600AT	01	CDF-216				
XV1700A/AT	04-5	CDF-216				
XV17 PCM ROADSTAR MIDNIGHT	08-09	CDF-295				
XV17 AW ROADSTAR	09	CDF-295				
XV17 AS ROADSTAR S	09	CDF-295				
XV17 AT ROADSTAR SILVERADO	09	CDF-295				
XV17 PC ROADSTAR WARRIOR	09	CDF-295				
XV1900A	06-07	CDF-2A7				
		KAWASAKI				
KX60A1/A2	83-84	CDF-426				
KX60B1-B14	85-98	CDF-426		CPL-0105		
KX60B15-B18	99-02	CDF-426		CPL-0105		
KX65A1-A6	00-05	CDF-426		CPL-0110		
KX65A6F/A7F	06-07	CDF-426		CPL-0110		
KX65A1-A3	00-02	CDF-426		CPL-0110		
KDX80B2/B3	82-83	CDF-426		CPL-0105		
KDX80A1-A2	80-81	CDF-427		CPL-0108		
KDX80C1-C5	84-88	CDF-426		CPL-0105		
KX80A1/A2	79-80	CDF-427		CPL-0108		
KX80C1-C2	81-82	CDF-426		CPL-0105		
KX80E1	83	CDF-426		CPL-0105		
KX80E2-E3	84-85	CDF-426		CPL-0105		
KX80G1-G2	86-87	CDF-428		CPL-0106		
KX80J2	87	CDF-428		CPL-0106		
KX80L1	88	CDF-430		CPL-0107		
KX80L2/L3	89-90			CPL-0107		
KX80N1	88	CDF-430		CPL-0107		
KX80N2/N3	89-90			CPL-0107		
KX80R1-R7	91-97			CPL-0106		
KX80T1-T4	91-94			CPL-0106		
KX80W1-W3	98-00	CDF-142		CPL-0138		
KD80A1/A2	75-76	CDF-427		CPL-0108		
KD80M1-M8	80-87	CDF-427		CPL-0108		
KD80N1/N3	88-90	CDF-427		CPL-0108		
KX85A1-A2	01-02	CDF-142		CPL-0138		

MODEL	YEAR	FRICTION DISC SET	H.D SPRING SET	CLUTCH PLATE SET	MASTERCYLINDER REPAIR KIT	SLAVE CYLINDER REPAIR KIT
KX85A3	03	CDF-446X		CPL-0138		
KX85	06-10	CDF-446X		CPL-0138		
KX85 B4-B5	04-05	CDF-446X		CPL-0138		
KX100B5-B7	95-97			CPL-0109		
KX100C1-C3	98-00	CDF-142		CPL-0138		
KX100D1/D2	01-02	CDF-142		CPL-0138		
KX100D5	05	CDF-446X		CPL-0138		
KX100	06-08	CDF-446X		CPL-0138		
KLX110A4	05	CDF-426		CPL-0110		
KLX110A6F	06	CDF-426		CPL-0110		
KLX110C	10	CDF-426		CPL-0110		
BN125A	05-09	CDF-464		CPL-0118		
KX125B2	83	CDF-434		CPL-0111		
KX125C1	84	CDF-434				
KX125D1/E1/E2	85-87	CDF-435		CPL-0116		
KX125F1	88	CDF-448		CPL-0142		
KX125G1	89	CDF-448		CPL-0115		
KX125H1/H2	90-91	CDF-436P		CPL-0114		
KX125J1	92	CDF-436P		CPL-0117		
KX125J2	93	CDF-438P		CPL-0121		
KX125K1-K3	94-96	CDF-450	HSP-402 4	CPL-0101		
KX125K4-K5	97-98	CDF-445X		CPL-0101		
KX125L1-L4	99-02	CDF-445X		CPL-0101		
KX125M1/M2	03-04	CDF-440P		CPL-0101		
KX125	05	CDF-440P		CPL-0101		
KLX125A3	05	CDF-375		CPL-0069		
KLX125A6F	06	CDF-375		CPL-0069		
KLX125B6F	06	CDF-375		CPL-0069		
KLX125LB3	05	CDF-375		CPL-0069		
KDX175A1-A3	80-82	CDF-433				
KZ200A1	78	CDF-416		CPL-0101		
KZ200A2	79	CDF-417		CPL-0101		
KDX200A	83-84	CDF-434				
KDX200A3	85	CDF-434				
KDX200C1/C2	86-87	CDF-435		CPL-0112		
KDX200C3	88	CDF-435		CPL-0116		
KDX200E1-E6	89-94	CDF-441P		CPL-0113		
KDX200H1-H2	95-96	CDF-442		CPL-0119		
KDX200H3-H11	97-05	CDF-442		CPL-0119		
KDX200H6F	06	CDF-442		CPL-0119		
KDX220A4-A11	97-04	CDF-442		CPL-0119		
KDX220R A12	05	CDF-442		CPL-0119		
KDX220H6-H8	00-02	CDF-442		CPL-0119		
EL250B2/B3	88-89	CDF-418	HSP-407 4	CPL-0088		
EL250E1-E4	91-94	CDF-418	HSP-407 4	CPL-0088		
EL250F6	03	CDF-418	HSP-407 4	CPL-0088		
EX250E1/E2	86-87	CDF-418	HSP-407 4	CPL-0088		
EX250F2/F3	88-90	CDF-418	HSP-407 4	CPL-0088		
EX250F6-F9	92-95	CDF-418	HSP-407 4	CPL-0088		
EX250F10-F19	96-05	CDF-418	HSP-407 4	CPL-0088		
EX250A6F	06	CDF-418	HSP-407 4	CPL-0088		
EX250H12/H14 ZZR250	01-03	CDF-418	HSP-407 4	CPL-0088		
EX250J	08-10	CDF-470				
KDX250A1/B1	80-81	CDF-425				
KDX250B2-B4	82-84	CDF-419		CPL-0126		
KDX250D1-D4	91-96	CDF-423P		CPL-0132		
KE250B1-B3	77-79	CDF-425		CPL-0147		
KL250A1-A5	81-83	CDF-417		CPL-0101		
KL250C1-C2	83-84	CDF-417		CPL-0101		
KL250D2-D22	85-05	CDF-416		CPL-0123		
KL250G	00-09	CDF-443P		CPL-0120		
KLX250A1/A2	82-83	CDF-417				
KLX250D2-D4	94-96	CDF-443P		CPL-0120		
KLX250H6F	06	CDF-443P		CPL-0120		
KLX250T	10	CDF-452		CPL-0120		
KLX250W	10	CDF-452		CPL-0120		
KX250A4/A5	78-79	CDF-424				
KX250A6-A7	80-81	CDF-425				
KX250B1/C1	82-83	CDF-419		CPL-0126		
KX250C	83-84	CDF-419		CPL-0126		
KX250D1	85			CPL-0127		
KX250D2	86			CPL-0127		
KX250E1	87-91	CDF-423P		CPL-0128		

MODEL	YEAR	FRICION DISC SET	H.D SPRING SET	CLUTCH PLATE SET	MASTERCYLINDER REPAIR KIT	SLAVE CYLINDER REPAIR KIT
KX250F1	88	CDF-423P		CPL-0131		
KX250G1	89	CDF-423P		CPL-0131		
KX250H1	90	CDF-423P		CPL-0131		
KX250H2	91	CDF-423P		CPL-0132		
KX250J1/J2	92-93	CDF-444		CPL-0129		
KX250K1-K5	94-98	CDF-444		CPL-0129		
KX250L1-L4	99-02	CDF-444		CPL-0129		
KX250M1/M2	03-04	CDF-444		CPL-0129		
KX250	05	CDF-444		CPL-0129		
KX250R6F/R7F	06-07	CDF-444		CPL-0129		
KX250F	04-05	CDF-370		CPL-0102		
KX250T6F/T7F K50F	06-09	CDF-367X		CPL-0102		
KX250X KX250F	10	CDF-367X		CPL-0102		
KZ250D1/D2	80-81	CDF-417		CPL-0101		
KZ250L1 CSR	82	CDF-417				
KZ250W1 LTD	83	CDF-417		CPL-0101		
KLX300A2-A10	97-05	CDF-443P		CPL-0120		
KLX300A6F	06	CDF-443P		CPL-0120		
EX305B1	83	CDF-419		CPL-0130		
KZ305A1-A2	81-82	CDF-419		CPL-0130		
KZ305B1 BELT	82	CDF-419		CPL-0130		
KZ305B2/B3	87-88	CDF-419		CPL-0130		
KZ400A1/A2	77-78	CDF-420		CPL-0086		
KZ400B1/B2	78-79	CDF-420		CPL-0086		
KZ400C1	78	CDF-420		CPL-0086		
KZ400D1-D4	74-77	CDF-420		CPL-0086		
KZ400H1 LTD	79	CDF-420		CPL-0086		
KZ400S/S2/S3	75-77	CDF-420				
KDX400A1/A2	79-80	CDF-425				
KZ440A1-A4 LTD	80-83	CDF-420		CPL-0086		
KZ440B1/B2	80-81	CDF-420		CPL-0086		
KZ440D1-D5 LTD	80-83	CDF-420		CPL-0086		
KZ440G1	82	CDF-420		CPL-0086		
EN450 A1-A6 LTD	85-90	CDF-404	HSP-406 5	CPL-0089		
KX450F	08-09	CDF-466		CPL-0065		
KX450F	10	CDF-471		CPL-0065		
H1/H1A/H1B 500	69-71	CDF-417		CPL-0101		
H1C/H1D/H1E/H1F	72-75	CDF-417		CPL-0101		
KX500A1-A2	83-84	CDF-419		CPL-0126		
KH500	76	CDF-417		CPL-0101		
EN500 A1-A7	90-96	CDF-404	HSP-406 5	CPL-0089		
EN500C	96-09	CDF-404	HSP-406 5	CPL-0089		
ER500A1-A3	97-99	CDF-404	HSP-406 5	CPL-0089		
ER500C1-C3	01-03	CDF-404	HSP-406 5	CPL-0089		
ER500D1	01	CDF-404	HSP-406 5	CPL-0089		
EX500 A1-A7	87-93	CDF-404	HSP-406 5	CPL-0089		
EX500B1-B4 GPZ500S	88-91	CDF-404	HSP-406 5	CPL-0089		
EX500D	94-09	CDF-404	HSP-406 5	CPL-0089		
EX500E9	02	CDF-404	HSP-406 5	CPL-0089		
KX500A	83-84	CDF-454		CPL-0126		
KX500B1/B2	85-86			CPL-0127		
KX500C1	87	CDF-423P	HSP-407 6	CPL-0128		
KX500D1	88	CDF-423P	HSP-407 6	CPL-0131		
KX500E1-E14	89-02	CDF-423P	HSP-401 6	CPL-0131		
KX500B13/B14	01-02	CDF-423P	HSP-401 6	CPL-0131		
KZ550 A	80-83	CDF-404	HSP-407 5	CPL-0089		
KZ550 C	80-83	CDF-404	HSP-407 5	CPL-0089		
KZ550 D1 GPZ	81	CDF-404	HSP-407 5	CPL-0089		
KZ550 F1/F2	83-84	CDF-404	HSP-407 5	CPL-0089		
KZ550 H GP	82-83	CDF-404	HSP-407 5	CPL-0089		
KZ550 M1 LTD	83	CDF-404	HSP-407 5	CPL-0089		
ZR550 B1-B4 ZEPHYR	90-93	CDF-404	HSP-407 5	CPL-0086		
ZX550 A GPZ	84-86	CDF-404	HSP-407 5	CPL-0089		
ZX600 A1-A3	85-87	CDF-404	HSP-407 5	CPL-0089		
ZX600 B1	87	CDF-404	HSP-407 5	CPL-0089		
ZX600 C1-C2	84-85	CDF-404	HSP-407 5	CPL-0089		
ZX600 C3-C9	86-96	CDF-404	HSP-407 5	CPL-0090		
ZX600 D1-D4	90-93	CDF-405P	HSP-401 5	CPL-0079		
ZX600 E1-E12	93-04	CDF-405P	HSP-404 5	CPL-0079		
ZX600 F1-F3 ZX-6R	95-97	CDF-407P	HSP-409 5	CPL-0094		
ZX600G1-G2	98-99	CDF-407P	HSP-409 4	CPL-0094		
ZX600J1	00	CDF-407P	HSP-409 4	CPL-0103		
ZX600J4	05	CDF-407P	HSP-409 4	CPL-0103		
ZX600J ZZR600	06-08	CDF-407P	HSP-409 4	CPL-0103		

MODEL	YEAR	FRICITION DISC SET	H.D SPRING SET	CLUTCH PLATE SET	MASTERCYLINDER REPAIR KIT	SLAVE CYLINDER REPAIR KIT
ZX600K1	03	CDF-407P		CPL-0103		
ZX600N1	05	CDF-460P		CPL-0124 *		
ZX600N6F ZX-6RR	06	CDF-460P		CPL-0124 *		
ZX600P ZX-6R	08	CDF-370		CPL-0156		
ZX600R ZX-6R	09-10	CDF-370		CPL-0156		
ZL600A1/A2	86-87	CDF-404		CPL-0079		
ZL600B2/B3	96-97	CDF-404		CPL-0079		
KL600A1/B1/B2	84-86	CDF-404		CPL-0089		
ZX636A1	02	CDF-407P	HSP-409 4	CPL-0103		
ZX636B1	03	CDF-407P		CPL-0125		
ZX636B2	04	CDF-407P		CPL-0103		
ZX636C1	05	CDF-460P		CPL-0096		
ZX636C6F ZX-6R	06	CDF-460P		CPL-0096		
ER650C ER-6N	09-10	CDF-463P	HSP-401 5	CPL-0079		
EX650A	06-08	CDF-463P	HSP-401 5	CPL-0082		
EX650C ER-6F	09-10	CDF-463P	HSP-401 5	CPL-0079		
EX650D	09-10	CDF-463P	HSP-401 5	CPL-0079		
KL650A1-A9	87-95	CDF-404	HSP-406 5	CPL-0092		
KL650A10-A19	96-05	CDF-403	HSP-414 5	CPL-0093		
KL650A6F/A7F	06-07	CDF-403	HSP-414 5	CPL-0093		
KL650B2/B3 TENGAI	90-91	CDF-404	HSP-406 5	CPL-0092		
KL650C9	03	CDF-403	HSP-414 5	CPL-0093		
KL650E	08-10	CDF-403	HSP-414 5	CPL-0093		
KLE650A	08	CDF-463P	HSP-401 5	CPL-0082		
KLX650A1-A3	93-95	CDF-404	HSP-401 5	CPL-0092		
KLX650C1-C4	93-96	CDF-404	HSP-406 5	CPL-0092		
KLX650D1	96	CDF-404				
EJ650A1-A4 W650	99-02	CDF-414P	HSP-406 5	CPL-0083		
EJ650C5	03	CDF-414P	HSP-406 5	CPL-0083		
KZ650 B	77-79	CDF-411	HSP-401 5	CPL-0084		
KZ650 C	77-79	CDF-411	HSP-401 5	CPL-0084		
KZ650 D	78-79	CDF-411	HSP-401 5	CPL-0084		
KZ650 F1/E1	80	CDF-411	HSP-401 5	CPL-0084		
KZ650 H	81-83	CDF-411	HSP-401 5	CPL-0084		
KZ750B1-B4	76-79	CDF-403	HSP-401 5	CPL-0083		
KZ750G1 LTD	80	CDF-403	HSP-401 5	CPL-0083		
KZ750 H LTD	80-83	CDF-411	HSP-401 5	CPL-0084		
KZ750 K LTD	83-84	CDF-403	HSP-407 5	CPL-0083		
KZ750 M1	82	CDF-403	HSP-401 5	CPL-0083		
KZ750 N	82-83	CDF-411	HSP-401 5	CPL-0084		
KZ750 R1 GP	82	CDF-411	HSP-401 5	CPL-0084		
ZR750 C1-C4 ZEPHYR	91-93	CDF-409P	HSP-401 5	CPL-0104		
ZR750F1-F5	99-03	CDF-446P		CPL-0104		
ZR750H1-H3	01-03	CDF-446P		CPL-0104		
ZR750K1	05	CDF-407P		CPL-0103		
ZR750K6F	06	CDF-407P		CPL-0103		
ZR750L	07-10	CDF-407P		CPL-0103		
ZX750A1/A2	83-84	CDF-411	HSP-401 6	CPL-0084		
ZX750E1/E2	84-85	CDF-421	HSP-401 6	CPL-0085		
ZX750 F1-F4	87-90	CDF-403	HSP-402 5		MSC-401	CCK-401
ZX750H1/H2	89-90	CDF-404	HSP-403 6	CPL-0089	MSC-401	CCK-401
ZX750J1/J2	91-92	CDF-403		CPL-0087	MSC-401	CCK-401
ZX750K1/K2	91-92	CDF-406P		CPL-0087	MSC-401	CCK-401
ZX750L1-L3	93-95	CDF-403		CPL-0087	MSC-401	CCK-401
ZX750M1/M2	93-94	CDF-406P		CPL-0087	MSC-401	CCK-401
ZX750N1/N2	96-97	CDF-406P	HSP-405 6	CPL-0087	MSC-401	CCK-401
ZX750P1-P2	96-97	CDF-403		CPL-0081	MSC-401	CCK-401
ZX750P3-P5	98-00	CDF-403		CPL-0081		CCK-401
VN750A2-A9 VULCAN	86-93	CDF-406P	HSP-401 5	CPL-0083		
VN750A10-A21	94-05	CDF-406P	HSP-401 5	CPL-0083		
VN750A6F	06	CDF-406P	HSP-401 5	CPL-0083		
VN800A1-A6	95-00	CDF-403	HSP-406 5			
VN800A10-A11	04-05	CDF-414P		CPL-0083		
VN800B1-B5	96-00	CDF-403	HSP-406 5			
VN800B6	01	CDF-403	HSP-406 5	CPL-0083		
VN800B7-B10	02-05	CDF-414P		CPL-0083		
VN800C1/C2	99-00	CDF-414P		CPL-0083		
VN800E1-E5	01-05	CDF-414P		CPL-0083		
VN800E6F	06	CDF-414P		CPL-0083		
KZ900 A	76-77	CDF-412	HSP-401 5	CPL-0085		
KZ900 B1 LTD	76	CDF-412	HSP-401 5	CPL-0085		
Z1 SERIES	73-75	CDF-412	HSP-401 5	CPL-0085		
ZL900A1-A2	85-86	CDF-402	HSP-403 6	CPL-0080	MSC-401	CCK-402
ZX900A1-A2	84-85	CDF-403	HSP-401 5	CPL-0083	MSC-401	CCK-402

MODEL	YEAR	FRICION DISC SET	H.D SPRING SET	CLUTCH PLATE SET	MASTERCYLINDER REPAIR KIT	SLAVE CYLINDER REPAIR KIT
ZX900A3	86	CDF-403	HSP-401 5	CPL-0083	MSC-401	CCK-402
ZX900 B1-B4 ZX-9R	94-97	CDF-406P	HSP-405 6	CPL-0087	MSC-401	CCK-401
ZX900 C1-C2 ZX-9R	98-99	CDF-408P	HSP-408 5	CPL-0095		
ZX900E1/E2	00-01	CDF-408P	HSP-408 5	CPL-0095		
ZX900F1/F2	02-03	CDF-408P		CPL-0095		
VN900B	07-10	CDF-467	HSP-401 5	CPL-0083		
VN900C	09-10	CDF-467	HSP-401 5	CPL-0083		
VN900D	09	CDF-467	HSP-401 5	CPL-0083		
KZ1000 A SERIES	77-80	CDF-412	HSP-401 5	CPL-0085		
KZ1000 B SERIES	77-80	CDF-412	HSP-401 5	CPL-0085		
KZ1000 D Z1R	78/80	CDF-412	HSP-401 5	CPL-0085		
KZ1000 E SHAFT		CDF-402	HSP-403 6	CPL-0080		
KZ1000J1/J2/J3	81-83	CDF-402	HSP-401 5	CPL-0080		
KZ1000K1/K2	81-82	CDF-402	HSP-401 5	CPL-0080		
KZ1000M1/M2	81-82	CDF-402	HSP-401 5	CPL-0080		
Z1000 R1	82	CDF-402	HSP-401 5	CPL-0080		
Z1000 R2	83	CDF-402	HSP-401 5	CPL-0080		
ZG1000A1-A20	86-05	CDF-402	HSP-403 6	CPL-0080	MSC-401	CCK-401
ZG1000A6F	06	CDF-402	HSP-403 6	CPL-0080		
ZG1000B10-B14	96-00	CDF-402	HSP-403 6	CPL-0080		
ZL1000A1	87	CDF-402	HSP-403 6	CPL-0080	MSC-401	CCK-402
ZR1000A1-A2	03-05	CDF-408P		CPL-0095		
ZR1000A6F	06	CDF-408P		CPL-0095		
ZR1000B	07-09	CDF-408P		CPL-0095		
ZR1000D	10	CDF-371		CPL-0166		
ZX1000 A1-A2	86-87	CDF-402	HSP-403 6	CPL-0080	MSC-401	CCK-402
ZX1000 B1 ZX10	89	CDF-402	HSP-403 6	CPL-0091	MSC-401	CCK-401
ZX1000 B2 ZX10	90	CDF-402	HSP-403 6	CPL-0091	MSC-401	CCK-401
ZX1000 B3	91		HSP-403 6	CPL-0091	MSC-401	CCK-401
ZX1000C1-C2	04-05	CDF-462P		CPL-0122		
ZX1000D7F ZX-10R	07	CDF-465		CPL-0150		
ZX1000E	09	CDF-357		CPL-0150		
ZX1000F ZX-10R	10	CDF-357		CPL-0150		
KZ1100A1-A3	81-83	CDF-402	HSP-403 6	CPL-0080		
KZ1100D1/D2	81-82	CDF-402	HSP-403 6	CPL-0080		
KZ1100L1 LTD	83	CDF-402	HSP-403 6	CPL-0080		
ZN1100B1/B2	84-85	CDF-402	HSP-403 6	CPL-0080		
ZR1100A1/A2/A3	92-94	CDF-422P	HSP-403 6	CPL-0080	MSC-401	CCK-401
ZR1100C1-C2	97-98	CDF-415P	HSP-403 6	CPL-0080	MSC-401	
ZR1100C3-C4	99-00	CDF-415P	HSP-403 6	CPL-0080	MSC-401	CCK-401
ZR1100D1/D2/D3	97-00	CDF-415P	HSP-403 6	CPL-0080		
ZX1100 A1/A2	83-84	CDF-402	HSP-403 6	CPL-0080		
ZX1100 C1-C4 ZX11	90-93	CDF-410P	HSP-411 6	CPL-0097	MSC-401	CCK-401
ZX1100 D1-D6	93-98	CDF-410P	HSP-411 6	CPL-0097	MSC-401	CCK-401
ZX1100 D7-D8	99-00	CDF-410P	HSP-411 6	CPL-0097	MSC-401	CCK-401
ZX1100 E1-E3	95-97	CDF-410P	HSP-411 6	CPL-0097	MSC-401	CCK-401
ZX1100F1 GPZ	96	CDF-410P	HSP-411 6	CPL-0097	MSC-401	CCK-401
ZG1200A1	86	CDF-402		CPL-0091		CCK-402
ZG1200B1-B5	87-91	CDF-402	HSP-403 6	CPL-0091	MSC-401	CCK-402
ZG1200B6-B11	92-97	CDF-402	HSP-403 6	CPL-0080	MSC-401	CCK-402
ZG1200B12-B14	98-00	CDF-402	HSP-403 6	CPL-0080	MSC-401	CCK-402
ZR1200A1-A5	01-05	CDF-458		CPL-0080	MSC-401	CCK-401
ZX1200A1	00	CDF-447P	HSP-418 6	CPL-0135		
ZX1200A2	01	CDF-456P	HSP-408 6	CPL-0135		
ZX1200B1-B4	02-05	CDF-456P	HSP-408 6	CPL-0135		
ZX1200C1-C4	02-05	CDF-461P	HSP-411 6	CPL-0097	MSC-401	CCK-402
Z1300A1-A3	79-81	CDF-413		CPL-0133		
KZ1300B2	80	CDF-413				
ZN1300A VOYAGER	83-86	CDF-401	HSP-401 5	CPL-0134		
ZN1300A VOYAGER	87-88	CDF-401	HSP-401 5	CPL-0134		
ZG1400C	10	CDF-472				
ZX1400D(ZZR1400)	08-10	CDF-473				
ZX1400B(ZZR1400)	06-07	CDF-470				
ZX1400A(ZZR1400)	06-07	CDF-470				
VN1500 A1-A11	87-98	CDF-401		CPL-0098	MSC-401	CCK-402
VN1500 A12	87-98	CDF-401		CPL-0098	MSC-401	CCK-402
VN1500 B1-B4	87-90	CDF-401		CPL-0098	MSC-401	CCK-402
VN1500 C3-C4	96-97	CDF-401		CPL-0098	MSC-401	CCK-402
VN1500 D1/D2	97-98	CDF-401		CPL-0098	MSC-401	CCK-402
VN1500 E1-E3	98-00	CDF-401		CPL-0098	MSC-401	CCK-402
VN1500G1/G1A/G2A	99-00	CDF-401		CPL-0098	MSC-401	CCK-402
VN1500J1/J2	99-00	CDF-401		CPL-0098	MSC-401	CCK-402
VN1500L1-L4	00-03	CDF-401		CPL-0098	MSC-401	CCK-402
VN1500N1-N4	00-05	CDF-401		CPL-0098	MSC-401	CCK-402

MODEL	YEAR	FRICION DISC SET	H.D SPRING SET	CLUTCH PLATE SET	MASTERCYLIN DER REPAIR KIT	SLAVE CYLINDER REPAIR KIT
VN1500N	06-08	CDF-401		CPL-0098		
VN1500P1-P2	02-03	CDF-455P		CPL-0098		
VN1500R1-R5	05-05	CDF-401		CPL-0098	MSC-401	CCK-402
VN1600A1-A3	03-05	CDF-401		CPL-0098	MSC-401	CCK-402
VN1600A6F/A7F	06-07	CDF-401		CPL-0098		
VN1600B2	05	CDF-401		CPL-0098	MSC-401	CCK-402
VN1600B6F	06	CDF-401		CPL-0098		
VN1600F6F	06	CDF-401		CPL-0098		
VN1600D1	05	CDF-401		CPL-0098	MSC-401	CCK-402
VN1600D	06-08	CDF-401		CPL-0098		
VN1700A	09	CDF-468		CPL-0100		
VN1700B	09	CDF-468		CPL-0100		
VN1700E	10	CDF-468		CPL-0100		
VN1700F	10	CDF-468		CPL-0100		
VN1700G	10	CDF-468		CPL-0100		
VN2000A2	05			CPL-0100		
VN2000A6F	06			CPL-0100		
VN2000D6F	06			CPL-0100		
VN2000 J/H/J/G	08-09	CDF-468		CPL-0100		
VN2000H	10	CDF-468		CPL-0100		
		SUZUKI				
RM65	03-04	CDF-426		CPL-0110		
DS80 F-N	85-92	CDF-348	HSP-314 5			
DS80 P/R/S	93-00	CDF-348	HSP-314 5			
RM80 G	86	CDF-349	HSP-309 4			
RM80 H/J	87-88	CDF-349	HSP-317 4			
RM80 K/L	89-90	CDF-325				
RM80 K-K1	91-01	CDF-325				
RM85	02-04	CDF-325				
RM85	07-09	CDF-325				
RM85L	03-05	CDF-325				
DR100 D-L	83-90	CDF-325	HSP-309 5	CPL-0069		
DR125E	84	CDF-325	HSP-309 5	CPL-0069		
DR125 G/H/J	86-88		HSP-309 5	CPL-0069		
DR125SE R/S/T	94-96			CPL-0069		
DR-Z125	09-10	CDF-375		CPL-0069		
DS125 N-X	79-81	CDF-325		CPL-0069		
DR-Z125/L	03-04	CDF-375		CPL-0069		
GN125Z/D	82-83	CDF-325	HSP-309 5	CPL-0069		
GN125EM/EN/EP/ER/ES	91-95	CDF-325	HSP-309 5	CPL-0069		
GN125ET/EV	96-97	CDF-325	HSP-309 5	CPL-0069		
GN125(U/E)V/W/X	97-99	CDF-325	HSP-309 5	CPL-0069		
GS125(S/U/ES/SU)X	99	CDF-325	HSP-309 5	CPL-0069		
GZ125(U)W/X	98-99	CDF-325	HSP-309 5	CPL-0069		
GZ125	08-10	CDF-325	HSP-309 5	CPL-0069		
RM125	81-83	CDF-328		CPL-0071		
RM125	84	CDF-329				
RM125	85	CDF-328		CPL-0071		
RM125	86-87	CDF-326		CPL-0070		
RM125	88-91	CDF-329				
RM125	92-97	CDF-339X		CPL-0072		
RM125	99-00	CDF-367X		CPL-0072		
RM125	01	CDF-339X		CPL-0072		
RM125	02-08	CDF-370		CPL-0072		
RV125	08-10	CDF-375		CPL-0069		
SP125 Z/D	82-83	CDF-325	HSP-309 5	CPL-0069		
SP125 G/H./J	86-88		HSP-309 5	CPL-0069		
TU125XTX	99	CDF-325	HSP-309 5	CPL-0069		
VL125	00	CDF-368P without rubber damper	HSP-305 4			
GT185K/L/M/A/B	73-77	CDF-326				
DR200 G/H/J	86-88			CPL-0070		
DR200SE	01-03	CDF-374				
DR200SE	04	CDF-373				
DR200SE	09	CDF-373				
DR250	82-83	CDF-327	HSP-301 4			
DR250 F	85	CDF-327	HSP-301 4			
DR250 L-P	90-93	CDF-310	HSP-309 6			
DR250E P/R/S	93-95	CDF-310	HSP-309 6	CPL-0054		
DR250S	90-92	CDF-310	HSP-309 6	CPL-0054		

MODEL	YEAR	FRICION DISC SET	H.D SPRING SET	CLUTCH PLATE SET	MASTERCYLIN DER REPAIR KIT	SLAVE CYLINDER REPAIR KIT
DR250SE	93-95		HSP-309 6	CPL-0054		
DR-Z250K1-K4	01-04	CDF-123P				
GN250Z/D	82-83	CDF-327	HSP-305 4			
GN250F	85	CDF-327	HSP-305 4			
GN250J	88	CDF-327	HSP-305 4			
GS250TT/TX	80-81	CDF-328				
GZ250	99-03	CDF-347				
GZ250	04-09	CDF-347				
RGV250 M/N/P/R	91-94	CDF-318				
RM250 T-F	80-85	CDF-350	HSP-305 4			
RM250 G	86	CDF-351	HSP-309 6			
RM250 H	87	CDF-351				
RM250 J-K	88-89	CDF-352		CPL-0055		
RM250 L/M	90-91	CDF-317		CPL-0055		
RM250 P/R/S	93-95	CDF-352		CPL-0055		
RM250 T	96	CDF-353		CPL-0073		
RM250	98-00	CDF-444				
RM250 K1/K2	01-02	CDF-444		CPL-0083		
RM250 K3-K5	03-05	CDF-366X		CPL-0083		
RM250	06-08	CDF-394		CPL-0083		
RM-Z250	07-10	CDF-367X		CPL-0158		
RMX250 K	89	CDF-333		CPL-0055		
RMX250 L	90-91	CDF-317		CPL-0055		
RMX250 N-P	92-93	CDF-354		CPL-0056		
RMX250 R/S/T/V/W	94-98	CDF-333		CPL-0055		
RM-Z250	04-06	CDF-370		CPL-0102		
VL250	05-07	CDF-377P (WITHO				
GS300LZ/LD	82-83	CDF-329				
GS300LE	85	CDF-329				
DR350 L-W	90-98	CDF-310	HSP-309 6	CPL-0054		
DR350S	90-94	CDF-310	HSP-309 6	CPL-0054		
DR350S(V/W)	97-98	CDF-310	HSP-309 6	CPL-0054		
DR350SE R-W	94-98	CDF-310	HSP-309 6	CPL-0054		
GS400B/XB/C/XC	77-78	CDF-314		CPL-0053		
GS400(C/EC/N/EN)	78-79	CDF-314	HSP-306 6	CPL-0053		
GSX400F X/Z	81-82	CDF-330	HSP-306 6			
GSX400E/S (T/X)	80-81	CDF-318				
GN400T/XT/XX/TX/TZ	80-82	CDF-330				
DR-Z400S	00-09	CDF-340		CPL-0065		
DR-Z400/E	00-06	CDF-340		CPL-0065		
DR-Z400 SM	05-08	CDF-340		CPL-0065		
GS425N/FN/LN	79	CDF-313				
GS450ET/EX/EZ/ED	80-83	CDF-318		CPL-0054		
GS450LT/LX/LZ/LD	80-83	CDF-318		CPL-0054		
GS450LF/LG/LH/LJ	85-88	CDF-318		CPL-0054		
GS450ST/SX	80-81	CDF-318		CPL-0054		
GS450TX/TZ/TXZ/TXD	81-83	CDF-318		CPL-0054		
RM-Z450	05-07	CDF-379P		CPL-0074		
RM-Z450	09-10	CDF-395P		CPL-0074		
RMX450E	10			CPL-0074		
DR500 X/Z	81-82	CDF-332	HSP-301 4			
DR500S X	81	CDF-332				
RM500 D/Z	83-84	CDF-317		CPL-0055		
GS500	03-05	CDF-378P		CPL-0054		
GSX550E/ES/EF/EU (F/G)	85-86	CDF-313	HSP-306 6			
GS500E(U)K/L/M/N/P/ R/S	89-95	CDF-318	HSP-313 6	CPL-0054		
GS500E(V/W/X/Y)	97-99	CDF-318	HSP-313 6	CPL-0054		
GS500E(Y-K2)	00-02	CDF-318	HSP-313 6	CPL-0054		
GS500E	03	CDF-318		CPL-0054		
GS500F	09	CDF-318	HSP-313 6	CPL-0054		
GS550B	77	CDF-313	HSP-306 6	CPL-0054		
GS550(C/EC/N/EN)	78-79	CDF-313	HSP-306 6	CPL-0054		
GS550(X/EX)	81	CDF-313	HSP-306 6	CPL-0054		
GS550ED	83	CDF-313				
GS550ES3/EFE/EFF/ES F/ESG	83-86	CDF-313				
GS550L	77-86	CDF-313				
GS550MZ KATANA	92	CDF-313				
GS550TX	81	CDF-313				
GSR600	06-10	CDF-135PM		CPL-0048		
GSF600S BANDIT	95-04	CDF-317	HSP-310 4			
GSX600F (J/K/L/M)	88-91	CDF-317	HSP-312 4			

MODEL	YEAR	FRICION DISC SET	H.D SPRING SET	CLUTCH PLATE SET	MASTERCYLINDER REPAIR KIT	SLAVE CYLINDER REPAIR KIT
GSX600F (N/P/R/S/T)	92-96	CDF-315P	HSP-310 6	CPL-0058		
GSX600F(V) KATANA	97	CDF-315P	HSP-310 6	CPL-0058		
GSX600F	98-03	CDF-322P	HSP-310 4			
GSX600F	04-06	CDF-322P				
GSX-R600WN/WP	92-93	CDF-315P	HSP-310 6	CPL-0060		
GSX-R600 W /X/Y	98-00	CDF-110PP		CPL-0061		
GSX-R600 K1/K3	01-03	CDF-361P W/RUB		CPL-0047		
GSX-R600 K1/K4	01-05	CDF-171P (W/O RUB.)		CPL-0047		
GSX-R600	06	CDF-390P	HSP-325 6	CPL-0076		
GSX-R600	07	CDF-390P	HSP-325 6	CPL-0151		
GSX-R600	08	CDF-392P	HSP-325 6	CPL-0155		
GSX-R600	09-10	CDF-392P	HSP-325 6	CPL-0155		
RF600R(U) P/R/S	93-95	CDF-316P	HSP-310 6	CPL-0059		
RF600R(U) T	96	CDF-316P	HSP-310 6			

DR600S F/G/H	85-87	CDF-332	HSP-301 4			
DR600SU F/G/H	85-87	CDF-332	HSP-301 4			
DL650	04-10	CDF-376	HSP-323 6	CPL-0054		
DR650S	90-93	CDF-355	HSP-301 4			
DR650SE	94-95	CDF-355	HSP-301 4			
DR650SE	09	CDF-323P				
DR650SE(U)T-K4	96-04	CDF-323P	HSP-312 4	CPL-0077 *		
GR650D/XD	83	CDF-331				
GS650 G(X/Z)	81-82	CDF-307	HSP-306 6			
GS650GLX/GLZ/GLD	81-83	CDF-307				
GS650MD KATANA	83	CDF-307				
GS650GT(X/Z)	81-82	CDF-307	HSP-306 5			
GSF650 BANDIT	05-06	CDF-322P				
LS650	09	CDF-332	HSP-312 4			
LS650FG/FH SAVAGE	86-88	CDF-332				
LS650PG/PH SAVAGE	86-88	CDF-332				
LS650P	95	CDF-332				
LS650P(-Y)	96-03	CDF-332	HSP-312 4			
XF650(U)V/W/X	97-99		HSP-312 4	CPL-0077		
SFV650	09-10	CDF-376		CPL-0054		
SV650(U/S/SU)X-K2	99-02	CDF-362P	HSP-319 6	CPL-0054		
		W/O RUBBER DAMPER				
SV650/S	03	CDF-376		CPL-0054		
SV650	04	CDF-376	HSP-323 6	CPL-0054		
SV650	05-10	CDF-376	HSP-323 6	CPL-0054		
SV650S	09	CDF-376	HSP-323 6	CPL-0054		
SV650S ABS	09	CDF-376	HSP-323 6	CPL-0054		
SV650SF	09	CDF-376	HSP-323 6	CPL-0054		
SV650SAF ABS	09	CDF-376	HSP-323 6	CPL-0054		
GS750						
C/DC/EC/N/DN/EN	78-79	CDF-312	HSP-305 6	CPL-0055		
GS750B/C/EC/N/EN	77-79	CDF-312	HSP-305 6	CPL-0055		
GS750SD KATANA	83	CDF-307				
GS750LN	79	CDF-312	HSP-305 6	CPL-0055		
GSX750 (W/X/Y)	98-00	CDF-322P	HSP-310 4			
GSX750(ESD/ESE/EFE/EE)	83-84	CDF-307	HSP-301 4			
GSX750(T/ET/X/EX)	80-81	CDF-307	HSP-305 6			
GSX750EZ	82	CDF-307	HSP-305 6			
GSX750F KATANA	89-94	CDF-315P	HSP-302 4	CPL-0058		
GSX750F(T/V)	96-97	CDF-315P	HSP-302 4	CPL-0058		
GSX750F	98-06	CDF-322P	HSP-310 4			
GSX750L(T/X)	80-81	CDF-307	HSP-305 6			
GSX-R750 F/G	85-86				MSC-301	
GSX-R750RG	86	CDF-334				
GSX-R750	86-87	CDF-317	HSP-301 4			CCK-301
GSX-R750	88-89	CDF-315P	HSP-302 4	CPL-0058		
GSX-R750	90-92	CDF-315P	HSP-310 6	CPL-0058		
GSX-R750	96-97	CDF-306P		CPL-0064		
GSX-R750 Y-K1	00-01	CDF-363P W/O RUB	HSP-322 6	CPL-0063		
GSX-R750 K1	01	CDF-366P W/RUB	HSP-322 6	CPL-0063		
GSX-R750K2-K3	02-03	CDF-372P W/RUB	HSP-322 6	CPL-0063		
GSX-R750K2-K3	02-03	CDF-360 W/O RUB	HSP-322 6	CPL-0063		
GSX-R750K4-K5	04-05	CDF-360 W/O RUB		CPL-0063		
GSX-R750K6	06	CDF-392P	HSP-325 6	CPL-0149		
GSX-R750	07	CDF-392P	HSP-325 6	CPL-0152		
GSX-R750	08-10	CDF-392P	HSP-325 6	CPL-0155		
GSX-R750W(N/P/R)	92-94	CDF-315P	HSP-310 6	CPL-0060		

MODEL	YEAR	FRICITION DISC SET	H.D SPRING SET	CLUTCH PLATE SET	MASTERCYLINDER REPAIR KIT	SLAVE CYLINDER REPAIR KIT
GSX-R750W(S)	95	CDF-315P	HSP-310 6	CPL-0060		
GSX-R750W/X	98-99	CDF-306PM		CPL-0064		
VL800	01-05	CDF-359				
VL800	06-10	CDF-359				
VS800GL	92-09	CDF-319	HSP-301 4			
VX800L/M/N/P	90-93	CDF-319				
VZ800V/W	97-98	CDF-319				
VZ800	99-07	CDF-359				
VZ800	08-10	CDF-359				
GS850G	79-83	CDF-307				
GS850GL	80-83	CDF-307				
RF900R	94	CDF-305P		CPL-0057		CCK-302
RF900R	95-97	CDF-306P	HSP-303 5	CPL-0062		CCK-302
DL1000	02-03	CDF-365P		CPL-0068	MSC-301	
DL1000	04-10	CDF-365P		CPL-0068		
GS1000ST	80	CDF-232				
GS1000 C/HC/EC	78	CDF-232	HSP-305 6			
GS1000 N/HN/EN	78-79	CDF-232	HSP-305 6			
GS1000SN	79	CDF-232	HSP-305 6			
GSX-R1000 K1-K4	01-04	CDF-371				
GSX-R1000	05-06	CDF-391P	HSP-325 6	CPL-0075		
GSX-R1000	07-08	CDF-393P	HSP-325 6	CPL-0153		
GSX-R1000	09-10	CDF-3A1	HSP-327 6	CPL-0167		
TL1000R	98	CDF-321P	HSP-320 6	CPL-0136		
TL1000R	99	CDF-321P	HSP-320 6	CPL-0136	MSC-301	
TL1000R	00	CDF-321P	HSP-320 6	CPL-0136		
TL1000R	01-03	CDF-358	HSP-320 6	CPL-0137		
TL1000S	97-98	CDF-306P	HSP-304 5	CPL-0064		
TL1000S	99-00	CDF-321P	HSP-320 6	CPL-0146		
GSX1100E	84-86	CDF-308P	HSP-305 6			
GSX1100ES	84-86	CDF-308P	HSP-305 6			
GSX1100EF	84-86	CDF-308P	HSP-305 6			
GSX1100	80-81	CDF-308P	HSP-305 6			
GSX1100E	80-81	CDF-308P	HSP-305 6			
GSX1100F	88-92	CDF-303P	HSP-302 4	CPL-0057	MSC-301	CCK-301
GSX1100F	93			CPL-0057		CCK-301
GSX1100G	91-93	CDF-301P		CPL-0057	MSC-301	CCK-302
GSX1100G	94	CDF-301P		CPL-0057	MSC-301	CCK-302
GSX-R1100	86-88	CDF-302	HSP-301 4	CPL-0057	MSC-301	CCK-302
GSX-R1100	89-92	CDF-305P				CCK-302
GSX-R1100W	93-94	CDF-304P		CPL-0057	MSC-301	CCK-302
GSX-R1100W	95-97	CDF-304P		CPL-0057		CCK-302
GSX-R1100W	98	CDF-304P		CPL-0057		
GSF1200	96			CPL-0064	MSC-301	
GSF1200	97	CDF-306P		CPL-0064	MSC-301	CCK-302
GSF1200	98-00	CDF-306P		CPL-0064		CCK-302
GSF1200S	01-02	CDF-360		CPL-0064	MSC-301	CCK-302
GSF1200S	03-05	CDF-360		CPL-0064		
GSF1200S	06	CDF-360		CPL-0064		
GSX1200X	99	CDF-306P		CPL-0064	MSC-301	
GV1200GLF/GLG	85-86	CDF-337				
GV1200GLF2	85	CDF-337				
GSF1250	08-10	CDF-122P		CPL-0145		
GSX1250FA	10	CDF-122P		CPL-0145		
GSX1300R(U1/U2) X	99	CDF-342	HSP-315 6	CPL-0068	MSC-301	CCK-302
GSX1300R	00-01	CDF-342		CPL-0068	MSC-301	CCK-302
GSX1300R	02	CDF-365P		CPL-0068	MSC-301	CCK-302
GSX1300R	03-10	CDF-365P		CPL-0068		
GSX1300B	08	CDF-365P		CPL-0068		
GSX1300BK	09-10	CDF-365P		CPL-0068		
VS1400GL	87-94	CDF-309	HSP-308 4			
VS1400GLP	97	CDF-309			MSC-301	
VS1400GLP	98	CDF-309			MSC-301	
VS1400GLP	99-09	CDF-309				
GV1400GCG/GCH	86-87	CDF-338				
GV1400GDG-GDK	86-89	CDF-338				
GV1400GTG/GTH	86-87	CDF-338				
VL1500	99-00	CDF-346				
VL1500	01-09	CDF-356		CPL-0078		
VZ1500	09	CDF-122P		CPL-0145		
VZ1600	04	CDF-401				

**NOTE: CPL-328/133 ARE NO LONGER AVAILABLE
CDF-275/CDF-210/CDF-211 /CDF-429 ARE NO LONGER AVAILABLE**

CLUTCH SLAVE CYLINDER PISTONS



HONDA

MSP-101	CB550SC	1983	
	CB650SC	83-85	
	CB700SC	84-86	
	PC800A	89-90	
	PC800A	94-98	
	VF750C	1988	
	VF700C	1987	
	VF700F	84-85	
	VF700S	84-85	
	VF700C	82-83	
	VF750F	83-84	
	VF750S	82-83	
	VF1100C	83-86	
	VF1100S	84-85	
	VT700	84-87	
	VT1100C	85-96	
	MSP-102	CB1300	05-07
CB1300A		05-07	
CB1300F		2003	
CB1300F1		2003	
CB1300S		05-06	
CB1300SA		05-07	
CBF1000		06-08	
CBF1000		06-08	
CBF1000S		07-08	
CBF1000T		07-08	
CBR1000RR		04-07	
MSP-103		VFR800	02-08
		VFR800A	02-08
MSP-104	CB1000F	93-96	
	CBR1000F	93-96	
	CBR1100X	97-06	
	GL1500A Goldwing	92-00	
	GL1500C Goldwing	01-03	
	GL1500CD Goldwing	01-03	
	GL1500CT Goldwing Valky	97-00	
	GL1500SE Goldwing SE	93-00	
	GL1800 Goldwing	06-08	
	GL1800 Goldwing	01-05	
	RVF750R	94-05	
	ST1100	92-00	
	ST1100A	92-00	
	ST1100P	93-96	
	ST1300	02-08	
	ST1300A	02-08	
	VF500C	84-85	
	VFR700F	1986	
	VFR700F2	86-87	
	VFR750R	1990	
	VFR750F	93-97	
	VFR800Fi	98-01	
	VTR1000F	97-00	
	VTR1000SP	00-06	
	VTX1800C1	05-08	
	VTX1800C	02-04	
	VTX1800F1	05-08	
	VTX1800F2	05-07	
	VTX1800F3	05-08	
	VTX1800N1	04-08	

KAWASAKI

MSP-401	ZX900A1-A3 Ninja	84-86
	ZX1000A1/A2 Ninja 1000R	86-87
	ZR1100A1-A4 Zephyr	92-95
	ZG1200A1 Voyager II	1986
	ZG1200B1-B17 Voyager II	87-03
	VN1500A1 Vulcan 88	1987
	VN1500B1 Vulcan 88	1987
MSP-402	GPX750R ZX750F1-F4	87-90
	GPZ1100	95-97
	GTR1000A	96-97
	GTR1000A	2003
	ZX750H1/H2 Stinger	89-90
	ZX750J1/J2 ZX-7	91-92
	ZX750L1-L3 ZX-7	93-95
	ZX750K1/K2 ZX-7R	91-92
	ZX750M1/M2 ZX-7	93-94
	ZX750P1-P8 ZX-7	96-03
	ZX750N1/N2 ZX-7RR	96-97
	ZX900B1-B4 ZX-9R	94-97
	ZX1000B1-B3 ZX-10	88-90
	ZX1100C1-C3 ZX-11	90-93
	ZX1100C1H/C2H	02-03
	ZX1100D1-D9 ZX-11	93-01
	ZR1100C3/C4 ZRX1100	99-00
	ZR1200C1P/C2P ZRX1200	01-03
	ZR1200C3H ZRX1200	2004
	ZR1200D1-D3 ZRX1200	97-99
	ZR1200A1P-A3P ZRX-R	01-03
	ZR1200A4H/A5H ZRX-R	04-05
	ZX1200A6F ZRX-R	2006
	ZX1200C1-C4 ZZR	02-05
	ZR1200B1P-B3P ZRX-S	01-03
	ZR1200B4H ZRX-S	2004
	VN1500A1-A13 Vulcan	87-99
	VN1500B1-B4 Vulcan SE	87-90
	VN1500C3/C4 Vulcan	96-97
	VN1500D1/D2 Classic	96-97
	VN1500E1-E7 Classic	98-04
	VN1500N1H-N4H Classic F	00-03
	VN1500N6F-N8F Classic	06-08
	VN1500T6F Classic	2006
	VN1500L-L5 Classic Nomad	00-04
	VN1500G1-G3 Classic Nomad	99-01
	VN1500J1/J2 Drifter	99-00
	VN1500P1H/P2H Main Street	02-03
	VN1500R1-R5 Drifter	01-05
	VN1600A1H/A2H Classic	03-05
	VN1600A6F-A8F Classic	06-08
	VN1600D1H Classic Tourer	2005
	VN1600D6F Classic Nomad	2006
	VN1600B1H/B2H Main Street	04-05
	VN1600B6F-B8F Main Street	06-08
	VN1600E6F Classic	2006
	VN1600F6F Main Street	2006
VN1600G6F Nomad	2006	
VN1700A9FA Voyager	2009	
VN1700B9FA Voyager ABS	2009	
VN1700C9F Nomad	2009	
VN1700E9F Classic	2009	
VN1700G9F Classic LT	2009	
ZG1000A1-A20 Concours	86-05	
ZG1000A6F Concours	2006	
ZL900A1/A2 Eliminator	85-86	
ZL1000A1 Eliminator	1987	

CLUTCH WEIGHT SET

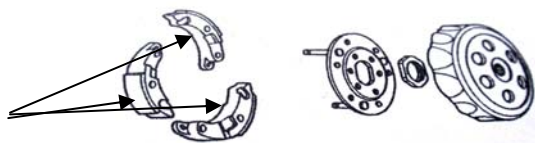

HONDA

CLW-101	NH80MD	93-94
	NH80MS	94-94
	NH90	93-94
	SH50D	93-95
	SH50	93-95
	SH100	01
	SH100	96,98-00
	SJ100	96-99
	SRX90	98-99
CLW-102	NES125	00-02
	NES150	00-02
	SH125	01
	SH150	01
CLW-103	FES125	01-02
	FES125	98-00
	FES150	98-02
CLW-104	CN250	97-99
	FES250	98-02
	FES250	05
	NSS250	01-04
	NSS250A	01,03-04
	NSS250EX	05,07
	NSS250X	05,07

CLW-105	CN250	93-97,99
CLW-106	CH125	92-94,96
CLW-107	PK50	01
	PK50M	95,01
	SFX50	95-98,01
	SFX50MM	98-00
	SFX50S	01
	SGX50	97-00,01
	SH50	96,98-01
	SJ50	93-99
	SRX50	98-99
	SZX50S	98-99,01
	SZX50X	98-99

SUZUKI

CLW-301	UH125	07
CLW-303	AN250	03-06
CLW-304	AN400	03-06

"O" RING DRIVE CHAINS

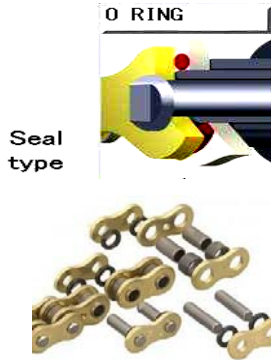

**TOUR
MAX**
IS PERFORMANCE EQUIPMENT

MADE IN JAPAN

****SUPPLIED IN COLOR G/G (GOLD)**

PRODUCED BY O.E.M for Japanese motorcycles

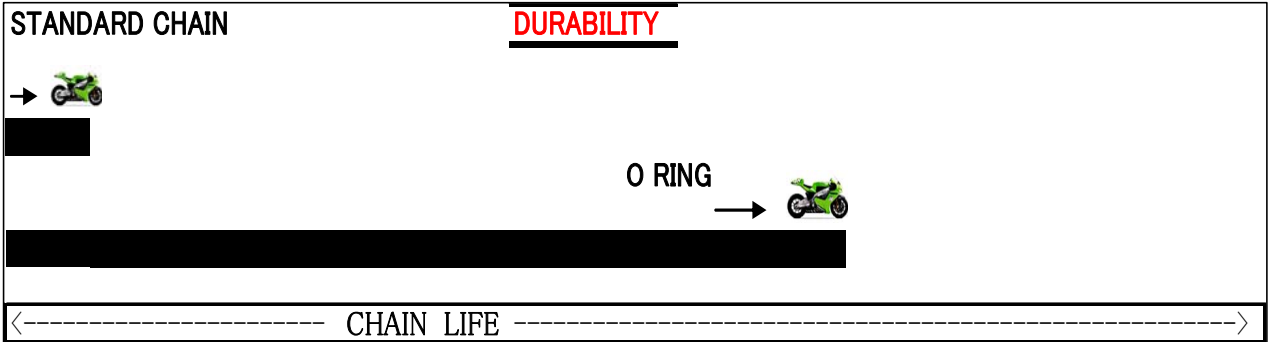

GENERAL MODEL APPLICATION			500	600	650	750	900	1000	1100	1400
	SEAL type	TENSILE STRENGTH (KN)								
TM520ZO	0	35.6								
TM525ZO	0	39.1								
TM530ZO	0	41.8								

cc	MODEL	YEAR	SIZE	LINK	SEAL TYPE	stock no
HONDA						
125cc	CA 125 REBEL	95-96	520	112	ZO	TM520ZO
	CRM125(L-Y)	90-00	520	108	ZO	TM520ZO
	MTX125(L-W)	90-98	520	106	ZO	TM520ZO
	NS125F(F-K)	85-89	520	106	ZO	TM520ZO
	NSR125F(G-H)	86-87	520	108	ZO	TM520ZO
	NSR125F(J-K)	88-89	520	108	ZO	TM520ZO
	NSR125F(L-M-N)	90-92	520	108	ZO	TM520ZO
	NSR125F(N-S)	92-94	520	108	ZO	TM520ZO
	NSR125R(ITALY)	87	520	106	ZO	TM520ZO
	NSR125R(K)	89	520	108	ZO	TM520ZO
200cc	MTX200R	83-96	520	104	ZO	TM520ZO
	TRX200SX		520	82	ZO	TM520ZO
	XL200R	82	520	104	ZO	TM520ZO
	XL200 PARIS DAKAR R,P3	83-88	520	104	ZO	TM520ZO
	XL200 R,P3	83-88	520	104	ZO	TM520ZO
	XLR20	93	520	106	ZO	TM520ZO
223cc	XR200R		520	108	ZO	TM520ZO
	FTR223	01-	520	110	ZO	TM520ZO
230cc	SL230	05	520	100	ZO	TM520ZO
	XR230	05-09	520	100	ZO	TM520ZO
	XL230	02	520	96	ZO	TM520ZO
	CB250F	04-	520	110	ZO	TM520ZO
	CB250T/N	78	530	102	ZO	TM530ZO
	CB250 NIGHTHAWK	91-00	520	108	ZO	TM520ZO
	CB250RS(A-F)	80-85	520	98	ZO	TM520ZO
	CB250T(B-D)	81-83	520	102	ZO	TM520ZO
	CB250 TWO FIFTY(N-W)	92-98	520	104	ZO	TM520ZO
	CBR250FOUR	86-	520	108	ZO	TM520ZO
	CBR250R HURRICANE	87-	520	108	ZO	TM520ZO
	CBX250(D)	83	520	102	ZO	TM520ZO
	CBX250RS(E-G)	84-86	520	100	ZO	TM520ZO
	CD250U	87-	520	98	ZO	TM520ZO
	CM250T	80	520	104	ZO	TM520ZO
	CMX250 REBEL(F-Y)	85-02	520	108	ZO	TM520ZO
	CRE250 MOTOSPA(N)	92	520	112	ZO	TM520ZO

cc	MODEL	YEAR	SIZE	LINK	SEAL	
					TYPE	stock no
250 CC	CRE250 MOTOSPA(N-T)	92-93	520	114	ZO	TM520ZO
	CRE250 MOTOSPA(R-T)	94-96	520	112	ZO	TM520ZO
	FTR250	86-	520	106	ZO	TM520ZO
	GB250 CLUBMAN	83-00	520	102	ZO	TM520ZO
	MX250	83-	520	104	ZO	TM520ZO
	NS250F/R	84-86	520	108	ZO	TM520ZO
	NSR250R	86-	520	108	ZO	TM520ZO
	NSR250R/SP	88-89	520	108	ZO	TM520ZO
	NSR250R/SE/SP	90-93	520	108	ZO	TM520ZO
	NSR250R/SE/SP	94-99	520	110	ZO	TM520ZO
	NX250(J-P)	88-93	520	102	ZO	TM520ZO
	TRX250R	86-89	520	96	ZO	TM520ZO
	TRX250X	87-92	520	86	ZO	TM520ZO
	VT250F/Z	82-87	520	104	ZO	TM520ZO
	VTR250	98-05	520	104	ZO	TM520ZO
	VTZ250	87-	520	104	ZO	TM520ZO
	XL250R(B-C)	81-82	520	102	ZO	TM520ZO
	XL250R(D-F)	83-85	520	100	ZO	TM520ZO
	XL250R(G-J)	86-88	520	100	ZO	TM520ZO
	XL250SZ,S(A-B)	84-87	520	102	ZO	TM520ZO
	XLR250R/F	86-87	520	102	ZO	TM520ZO
	XLX250R	83-	520	102	ZO	TM520ZO
	XR250L(L-T)	90-96	520	104	ZO	TM520ZO
	XR250R(E-F)	84-85	520	108	ZO	TM520ZO
	XR250R(G-H)	86-87	520	108	ZO	TM520ZO
	XR250R(J-K)	88-89	520	108	ZO	TM520ZO
XR250R(L-R)	90-94	520	112	ZO	TM520ZO	
XR250R(S-T)	95-96	520	106	ZO	TM520ZO	
XR250R(V-Y)	97-04	520	106	ZO	TM520ZO	
XR250R	05	520	106	ZO	TM520ZO	
260CC	CRE260 MOTOSPA(V-Y)	97-01	520	114	ZO	TM520ZO
350cc	CB350FOUR	72	530	96	ZO	TM530ZO
	CB350S(S-J)	86-88	525	108	ZO	TM525ZO
	XL350R(E-H)	84-87	520	102	ZO	TM520ZO
	XR350R(D-E)	83-84	520	104	ZO	TM520ZO
400cc	CB400LC	82	530	106	ZO	TM530ZO
	CB400N(B-C)	81-82	520	100	ZO	TM520ZO
	CB400N(D)	83	520	100	ZO	TM520ZO
	CB400N MODIF RAPP	78-80	530	100	ZO	TM530ZO
	CB400S	84	530	106	ZO	TM530ZO
	CB400SF	-95	525	110	ZO	TM525ZO
	CB400SF V-TECH	99-	525	108	ZO	TM525ZO
	CB400SF VERSION S/R	-98	525	112	ZO	TM525ZO
	CB400SF HIPER V-TEC	99-01	525	108	ZO	TM525ZO
	CB400SF HIPER V-ETC II III	03-	525	108	ZO	TM525ZO
	CB400SS	02-	520	104	ZO	TM520ZO
	CB400T	78-80	530	100	ZO	TM530ZO
	CB400FOUR	97-01	525	110	ZO	TM525ZO
	CBR400F/ENDURANCE/F3	83-85	525	106	ZO	TM525ZO
	CBR400R AERO	86-	525	108	ZO	TM525ZO
	CBR400RR	88-89	525	106	ZO	TM525ZO
	CBR400RR	90-	525	102	ZO	TM525ZO
	CBX400F,F2	82-83	530	104	ZO	TM530ZO
	CL400	98-02	520	104	ZO	TM520ZO
	CM400T©	82	520	102	ZO	TM520ZO
	GB400TT	85-	525	108	ZO	TM525ZO
	NS400F/R	85-88	530	108	ZO	TM530ZO
	NT400 BROS	94-	525	114	ZO	TM525ZO
	NT400 BROS	87-	525	112	ZO	TM525ZO
	NV400DC	07-	520	124	ZO	TM520ZO
	RVF400	94-	525	102	ZO	TM525ZO
VF400F	82-85	530	108	ZO	TM530ZO	
VFR400R(NC30)	88	525	104	ZO	TM525ZO	
VFR400R/Z	86-	525	106	ZO	TM525ZO	
VFR400R	87-89	525	106	ZO	TM525ZO	
XL400R(C-D)	82-83	520	98	ZO	TM520ZO	
XR400R(T-Y)	98-00	520	108	ZO	TM520ZO	
450CC	CB450DX(K)	89-90	525	108	ZO	TM525ZO
	CB450SG(PS-27)	86-88	525	108	ZO	TM525ZO
	CB450SG(PS-44)	86-88	525	108	ZO	TM525ZO
	CMX450C(G-H)	86-87	525	112	ZO	TM525ZO
500cc	CB500	04	525	112	ZO	TM525ZO
	CB500	05	525	116	ZO	TM525ZO
	CB500(R-Y)	96-00	525	108	ZO	TM525ZO
	CB500K,F	71-79	530	98	ZO	TM530ZO
	CB500K3	75-77	530	100	ZO	TM530ZO
	CB500T	75-77	530	98	ZO	TM530ZO
	CRE500 MOTOSPA(N)	92	520	112	ZO	TM520ZO
	CRE500 MOTOSPA(PR)	93-94	520	114	ZO	TM520ZO
	CRE500 MOTOSPA(S-T)	95-96	520	114	ZO	TM520ZO
	CRE500 MOTOSPA(V-Y)	97-00	520	114	ZO	TM520ZO
	FT500C, VT500C	82	530	100	ZO	TM530ZO
	GB500TT	85-	525	108	ZO	TM525ZO
	VF500F(D)	83	530	106	ZO	TM530ZO
	VF500F2(E)	84	530	108	ZO	TM530ZO
	VF500F2(F)	85	530	106	ZO	TM530ZO
	XBR500F(27CV)	85-86	525	106	ZO	TM525ZO
	XBR500F(42CV)	85-86	525	106	ZO	TM525ZO

cc	MODEL	YEAR	SIZE	LINK	SEAL	
					TYPE	stock no
	XBR500S(27CV)	87-91	525	106	ZO	TM525ZO
	XBR500S(44CV)	87-91	525	106	ZO	TM525ZO
	XL500R©	82	520	100	ZO	TM520ZO
	XL500S(A-B)	79-81	520	96	ZO	TM520ZO
	XR500R(B-F)	81-85	520	104	ZO	TM520ZO
	XR500SA,SZ	79-80	520	104	ZO	TM520ZO
550cc	CBX550F©	83-86	530	104	ZO	TM530ZO
	CBX550F,F2	81-83	530	104	ZO	TM530ZO
	CBF600	-07	525	116	ZO	TM525ZO
	CBR600F/FS	01-02	525	108	ZO	TM525ZO
	CBR600F/N/R/R2		525	106	ZO	TM525ZO
	CBR600F-1/2	90-93	530	110	ZO	TM530ZO
	CBR600F-3	96-97	525	108	ZO	TM525ZO
	CBR600F-4	99-00	525	108	ZO	TM525ZO
	CBR600F4I	01-	525	108	ZO	TM525ZO
	CBR600RR	03-09	525	112	ZO	TM525ZO
	XLV600 TRANSALP	87-00	525	118	ZO	TM525ZO
	VT600C	88-93	525	120	ZO	TM525ZO
	VT600C SHADOW(J-P)	88-93	525	120	ZO	TM525ZO
	VT600C SHADOW(R-W)	94-02	525	120	ZO	TM525ZO
	XL600L(D-E-F)	83-85	520	104	ZO	TM520ZO
	XL600RM(G)	86	520	106	ZO	TM520ZO
600CC	XL600V TRANSALP	91-99	525	118	ZO	TM525ZO
	XL600V TRANSALP	87-88	525	118	ZO	TM525ZO
	XL600V TRANSALP	89-90	525	118	ZO	TM525ZO
	XR600R(F-H)	85-87	520	110	ZO	TM520ZO
	XR600R(J-K-L)	88-90	520	112	ZO	TM520ZO
	XR600R(M-V)	91-00	520	112	ZO	TM520ZO
	XR600RR(W-Y)	98-01	520	112	ZO	TM520ZO
	CB650B,Z	79	530	100	ZO	TM530ZO
	CB650C CUSTOM(D-F)	83-85	530	106	ZO	TM530ZO
	CB650KZ	80-81	530	100	ZO	TM530ZO
	CB650SC NIGHTHAWK	81-82	530	108	ZO	TM530ZO
	FX650 VIGOR(X-Y)	99-00	520	110	ZO	TM520ZO
	NT650 BROS	87-91	525	112	ZO	TM525ZO
	NX650 DOMINATOR(K-M)	89-91	520	108	ZO	TM520ZO
	NX650 DOMINATOR(N-S)	92	520	110	ZO	TM520ZO
	NX650 DOMINATOR(T-Y)	96-00	520	108	ZO	TM520ZO
	SLR650(V-W-X)	97-98	520	110	ZO	TM520ZO
	XL650V TRANSALP(Y)	99-04	525	118	ZO	TM525ZO
	XR650L	93-99	520	110	ZO	TM520ZO
	XR650R	00-04	520	112	ZO	TM520ZO
	XR650 AFRICA TWIN(J-L)	88-90	525	124	ZO	TM525ZO
	CB750	92-06	525	124	ZO	TM525ZO
	CB750SC(C-D)	82-83	530	108	ZO	TM530ZO
	CB750 NIGHTHAWK	91-	525	108	ZO	TM525ZO
	CB750FA/FB/FC	80-83	530	108	ZO	TM530ZO
	CB750F	05	525	112	ZO	TM525ZO
	CBR750 AERO	87-	530	116	ZO	TM530ZO
	CBX750F,F2	85	530	114	ZO	TM530ZO
	VF750C(T-W)	96-00	530	120	ZO	TM530ZO
	VF750 CUSTOM(P-S)	93-95	530	120	ZO	TM530ZO
	VFR750F	86-	530	110	ZO	TM530ZO
	VFR750F (PROARM)	90-98	525	112	ZO	TM525ZO
	VFR750R(RC30)	87-	525	106	ZO	TM525ZO
	VT750 BLACK WIDOW	04	525	124	ZO	TM525ZO
	VT750 SHADOW	02	525	122	ZO	TM525ZO
	VT750 SHADOW(V-Y)	97-01	525	122	ZO	TM525ZO
	XR750 AFRICA TWIN	88-	525	124	ZO	TM525ZO
	XR750 AFRICA TWIN	93-95	525	122	ZO	TM525ZO
	XR750 AFRICA TWIN	95-02	525	124	ZO	TM525ZO
800cc	VFR800	98-00	530	108	ZO	TM530ZO
	VFR800	01-07	530	110	ZO	TM530ZO
900 cc	CB900F	79-84	530	106	ZO	TM530ZO
	CBR900RR FIREBLADE	92-95	530	108	ZO	TM530ZO
929CC	CBR929RR FIREBLADE	00-01	530	108	ZO	TM530ZO
954CC	CBR954RR	02-	530	108	ZO	TM530ZO
	CBF1000	06-07	530	120	ZO	TM530ZO
	CBR1000F(H-J)	97,99	530	114	ZO	TM530ZO
	CBR1000F(K-S)	89-95	530	114	ZO	TM530ZO
	CBR1000F	87-88	530	114	ZO	TM530ZO
	CBR1000R	95	530	114	ZO	TM530ZO
	CBR1000RR	04-07	530	114	ZO	TM530ZO
	CBR1000RR	08-09	530	116	ZO	TM530ZO
	CBX1000	80	530	102	ZO	TM530ZO
	VF1000F/R	84	530	110	ZO	TM530ZO
	VTR1000F(V-X)	97-04	530	102	ZO	TM530ZO
	VTR1000SP1	00-01	530	104	ZO	TM530ZO
	VTR1000SP2	02-	530	106	ZO	TM530ZO
YAMAHA						
125cc	VIRAGO125 (XV125)	97-	520	114	ZO	TM520ZO
	WR200R	92	520	116	ZO	TM520ZO
200cc	WR200R	93-95	520	116	ZO	TM520ZO
	DT200WR	91-	520	110	ZO	TM520ZO
	RD250DXE	76-77	530	96	ZO	TM530ZO
	RD250LC	80-82	530	102	ZO	TM530ZO
	RZ250R/RR	83-	520	110	ZO	TM520ZO

cc	MODEL	YEAR	SIZE	LINK	SEAL	
					TYPE	stock no
250cc	RZ250R	86-	520	108	ZO	TM520ZO
	SR250SE	80-83	520	102	ZO	TM520ZO
	SR250SE	88-92	520	102	ZO	TM520ZO
	SRX250/F	84-	520	106	ZO	TM520ZO
	TDR250	88-	520	108	ZO	TM520ZO
	TT250	87	520	108	ZO	TM520ZO
	TT250R(4GY1/4PR1,2)	93-	520	106	ZO	TM520ZO
	TTR250	00	520	106	ZO	TM520ZO
	TZ250	96	520	108	ZO	TM520ZO
	TZR250	87-89	520	110	ZO	TM520ZO
	WR250(YZ-WR)	91-92	520	116	ZO	TM520ZO
	WR250V	97	520	112	ZO	TM520ZO
	WR250W	98-99	520	114	ZO	TM520ZO
	WR250Z	91-96	520	116	ZO	TM520ZO
	WR250Z	02	520	114	ZO	TM520ZO
	WR250F	02	520	114	ZO	TM520ZO
	WR250R	07-	520	108	ZO	TM520ZO
	WR250X	07-	520	108	ZO	TM520ZO
XT250	80-83	520	98	ZO	TM520ZO	
XV250 VIRAGO	95-98	520	114	ZO	TM520ZO	
350cc	TT350	86-87	520	108	ZO	TM520ZO
	RZ350R/RR	83-85	520	106	ZO	TM520ZO
400cc	FZ400	87-88	520	104	ZO	TM520ZO
	FZ400	89	520	104	ZO	TM520ZO
	XJ400	82	530	104	ZO	TM530ZO
	XS400 12E,12F	82-85	530	102	ZO	TM530ZO
	XS400 DOHC	82	530	102	ZO	TM530ZO
	XT400	81-82	520	102	ZO	TM520ZO
500cc	XT400	83	520	100	ZO	TM520ZO
	SR500	78-87	530	104	ZO	TM530ZO
	SR500T	88	530	104	ZO	TM530ZO
	XT500	77-83	520	100	ZO	TM520ZO
550cc	XT500E	86	520	102	ZO	TM520ZO
	XT550	82-84	520	98	ZO	TM520ZO
600cc	FZ600	88	530	104	ZO	TM530ZO
	FZ-6S/N	04	530	118	ZO	TM530ZO
	FZS600 FAZER	98-02	530	110	ZO	TM530ZO
	FZR600	89-93	530	106	ZO	TM530ZO
	FZR600R	94-97	530	108	ZO	TM530ZO
	SRX600	82-89	520	104	ZO	TM520ZO
	TT600	80-82	520	112	ZO	TM520ZO
	TT600	83-92	520	112	ZO	TM520ZO
	TT600E	93-95	520	110	ZO	TM520ZO
	TT600R	'96-'00	520	110	ZO	T M520ZO
	TT600 L,N	83-92	520	112	ZO	TM520ZO
	DIVERSION 600	92-	520	110	ZO	TM520ZO
	XJ600	83	530	106	ZO	TM530ZO
	XJ600S/N	-02	520	110	ZO	TM520ZO
	XT600E,EB,EV	89-98	520	106	ZO	TM520ZO
	XT600 TENERE	83-85	520	102	ZO	TM520ZO
	XT600 TENERE	87-94	520	102	ZO	TM520ZO
	XT600Z TENERE	87-90	520	104	ZO	TM520ZO
YZF600R THUNDER CAT	-02	530	108	ZO	TM530ZO	
YZF-R6	06-	525	114	ZO	TM525ZO	
650cc	XJ650	86	530	104	ZO	TM530ZO
	XJ650N	95	520	110	ZO	TM520ZO
	XJ650S	95	520	110	ZO	TM520ZO
	XS650/SE	75-81	530	104	ZO	TM530ZO
660cc	XTZ660 TENERE	91-95	520	110	ZO	TM520ZO
	XTZ660 TENERE	96-98	520	110	ZO	TM520ZO
750cc	FZR750	98-02	530	108	ZO	TM530ZO
	FZ750	85-87	530	110	ZO	TM530ZO
	FZX750	86-89	530	108	ZO	TM530ZO
	FZX750	90-	530	108	ZO	TM530ZO
	YZF-R7	99-	530	118	ZO	TM530ZO
	YZX750		530	108	ZO	TM530ZO
1000cc	FZS1000 FAZER	01-04	530	116	ZO	TM530ZO
	FZ1 FAZER	-08	530	122	ZO	TM530ZO
	YZF1000	98	530	114	ZO	TM530ZO
	YZF-R1	09-03	530	114	ZO	TM530ZO
	YZF-R1	04-05	530	116	ZO	TM530ZO
	YZF-R1	06-08	530	118	ZO	TM530ZO
	YZF-R1	09	530	120	ZO	TM530ZO
SUZUKI						
250cc	DR250(L-M-N-P)	90-93	520	110	ZO	TM520ZO
	DR250R	98-00	520	108	ZO	TM520ZO
	DR250S/SH	82-86	520	106	ZO	TM520ZO
	GF250/S	85	520	108	ZO	TM520ZO
	GSF250 BANDIT	89-	520	116	ZO	TM520ZO
	GSF250 BANDIT /V/VZ	95-99	520	114	ZO	TM520ZO
	GN250	82-96	520	100	ZO	TM520ZO
	GN250E	82-	520	100	ZO	TM520ZO
	GNX250E	82	520	100	ZO	TM520ZO
	GSX250ES(Z)	79-85	520	110	ZO	TM520ZO
	GSX250ET,T	80-81	520	110	ZO	TM520ZO
	GSX250FX	02-	520	114	ZO	TM520ZO
	GSX250S KATANA	91-99	520	116	ZO	TM520ZO

cc	MODEL	YEAR	SIZE	LINK	SEAL	
					TYPE	stock no
	GSX-R250	87-	520	108	ZO	TM520ZO
	GSX-R250R	89-	520	112	ZO	TM520ZO
	GZ250 MARAUDER	99-01	520	110	ZO	TM520ZO
	RG250(G)	83-86	520	110	ZO	TM520ZO
	RGV250(K-L)	89-90	520	114	ZO	TM520ZO
	RGV250(M-S)	91-97	520	114	ZO	TM520ZO
	RMX250S	92-	520	112	ZO	TM520ZO
	RMX250ST/SV	96-99	520	112	ZO	TM520ZO
	RMX250T	96-99	520	114	ZO	TM520ZO
	TU250X VOLTY	97-05	520	100	ZO	TM520ZO
VL250 INTRUDER	00-02	520	114	ZO	TM520ZO	
350cc	DR350S,R	94-95	520	110	ZO	TM520ZO
	DR350S,SE	90-94	520	108	ZO	TM520ZO
	DR350S,SE	95-96	520	110	ZO	TM520ZO
	DR350SE(V-W)	97-01	520	108	ZO	TM520ZO
	DR400ST	80-81	520	108	ZO	TM520ZO
400cc	DR400ST,SX	79-80	520	108	ZO	TM520ZO
	DR-Z400S	00-05	520	110	ZO	TM520ZO
	DR-Z400SM	04-05	520	110	ZO	TM520ZO
	GN400 T/X	80-81	520	102	ZO	TM520ZO
	GS400E/X	77-80	530	104	ZO	TM530ZO
	GSF400(M-N)	91-92	525	114	ZO	TM525ZO
	GSF400(P-R-S)	93-96	525	114	ZO	TM525ZO
	GSF400E(ZD)	82-86	530	110	ZO	TM530ZO
	GSX400 F	81-82	530	104	ZO	TM530ZO
	GSX400FW	83	530	112	ZO	TM530ZO
	GSX400FX,FZ	84-88	530	104	ZO	TM530ZO
	GSX400S KATANA	92-00	525	116	ZO	TM525ZO
	GSX400X KATANA	86-88	530	104	ZO	TM530ZO
	GSX-R	86	525	114	ZO	TM525ZO
	GSX-R	84	525	112	ZO	TM525ZO
	GSX-R400	88	525	110	ZO	TM525ZO
	GSX-R400R	90-98	525	108	ZO	TM525ZO
	GSX-R400R/SP	90-98	525	108	ZO	TM525ZO
	LS400 SAVAGE	92-94	525	108	ZO	TM525ZO
	RF400RV	95-00	525	110	ZO	TM525ZO
450cc	GS425, GS450E	81-83	530	104	ZO	TM530ZO
	GS450L	81-82	530	108	ZO	TM530ZO
500cc	DR500S	82	520	106	ZO	TM520ZO
	DR500SR	82-86	520	108	ZO	TM520ZO
	GS500E(P-R)	93-94	520	110	ZO	TM520ZO
	GS500E(K-L-M-N)	90-92	520	112	ZO	TM520ZO
	GS500E(R-S-T-W-X)	94-04	520	110	ZO	TM520ZO
550cc	GS550E,T	77-80	530	110	ZO	TM530ZO
	GS550 KATANA	83	530	112	ZO	TM530ZO
	GS550M	81-82	530	112	ZO	TM530ZO
	GSX550E,D	83-88	530	112	ZO	TM530ZO
600cc	DR600S,R	85-89	520	108	ZO	TM520ZO
	GSF600		530	110	ZO	TM530ZO
	GSF600/S BANDIT	95-04	530	110	ZO	TM530ZO
	GSX600ES(G-H)	86	530	112	ZO	TM530ZO
	GSX-R600F(J-K)	88-89	530	112	ZO	TM530ZO
	GSX-R600F(L-M)	90-91	530	112	ZO	TM530ZO
	GSX-R600F(N-V)	92-97	530	112	ZO	TM530ZO
	GSX-R600	01-03	525	110	ZO	TM525ZO
	GSX-R600	04-05	525	112	ZO	TM525ZO
	GSX-R600	06-09	525	114	ZO	TM525ZO
	GSX-R600V	97-00	525	108	ZO	TM525ZO
	GSX600F	-95	530	112	ZO	TM530ZO
GSX600F(W-X-Y)	98-04	530	118	ZO	TM530ZO	
GSR600	06-08	525	114	ZO	TM525ZO	
650cc	DR650V STROM	04	525	116	ZO	TM525ZO
	DR650R DJEBEL	90-95	520	114	ZO	TM520ZO
	DR650SE(T-W-X-Y)	96-00	525	110	ZO	TM525ZO
	GR650	83-85	530	104	ZO	TM530ZO
	SV650	99-04	525	110	ZO	TM525ZO
	SV650S	99-04	525	108	ZO	TM525ZO
XF650 FREEWIND	97-01	525	110	ZO	TM525ZO	
750cc	GSX750F	88-	530	118	ZO	TM530ZO
	GSX-R750	87	530	110	ZO	TM530ZO
	GSX-R750	88-	530	106	ZO	TM530ZO
	GSX-R750	90-94	530	108	ZO	TM530ZO
	GSX-R750	98-99	525	108	ZO	TM525ZO
1000cc	GSX-R750	00-05	525	110	ZO	TM525ZO
	GSX-R1000	01-06	530	110	ZO	TM530ZO
	GSX-R1000	07-08	530	112	ZO	TM530ZO
	SV1000S	03-04	530	108	ZO	TM530ZO
	TL1000R	98-02	530	108	ZO	TM530ZO
TL1000S	97-02	530	104	ZO	TM530ZO	
KAWASAKI						
200cc	KDX200(C1-C3)	86-88	520	110	ZO	TM520ZO
	KDX200(E1-E6)	89-94	520	110	ZO	TM520ZO
	Z200-A(A1-A6)	77-83	520	98	ZO	TM520ZO
220cc	KDX220(A4-A7)	97-00	520	112	ZO	TM520ZO
	KDX220(R4-R7)	97-00	520	108	ZO	TM520ZO
	GPX250R	87-88	520	106	ZO	TM520ZO
	EL250-B ELIMINATOR	88-95	520	114	ZO	TM520ZO

cc	MODEL	YEAR	SIZE	LINK	SEAL	
					TYPE	stock no
250cc	GPZ250R	85-	520	104	ZO	TM520ZO
	NINJA 250R	08-09	520	106	ZO	TM520ZO
	KDX250SR	91-94	520	110	ZO	TM520ZO
	KDX250	91-96	520	112	ZO	TM520ZO
	KL250	78-82	520	96	ZO	TM520ZO
	KL250(A1-A5)	78-85	520	96	ZO	TM520ZO
	KL250R	84-	520	104	ZO	TM520ZO
	KLE250	93-02	520	106	ZO	TM520ZO
	KLX250	82	520	108	ZO	TM520ZO
	KLX250(C1-C2)	83-84	520	106	ZO	TM520ZO
	KLX250(C3-C5)	85-95	520	106	ZO	TM520ZO
	KLX250ES	94-97	520	106	ZO	TM520ZO
	KLX250SR	93-97	520	106	ZO	TM520ZO
	KLX250R	93-98	520	110	ZO	TM520ZO
	KR250/S	84-	520	98	ZO	TM520ZO
	Z250A-B-M LTD	80	520	102	ZO	TM520ZO
	Z250C1-C2-G2	80	520	102	ZO	TM520ZO
ZZR250	05	520	106	ZO	TM520ZO	
ZZR250	92-02	520	108	ZO	TM520ZO	
300cc	EX305-A(GPZ)	80-83	530	100	ZO	TM530ZO
400cc	GPZ400	84-87	520	106	ZO	TM520ZO
	Z400B	74-79	530	100	ZO	TM530ZO
	Z400D	74-76	530	100	ZO	TM530ZO
	Z400G	74-79	530	100	ZO	TM530ZO
	Z400J	80-82	530	100	ZO	TM530ZO
	ZZ-R400	90-92	530	112	ZO	TM530ZO
	ZZ-R400	93-03	530	114	ZO	TM530ZO
ZR400F(A1)	83-85	520	104	ZO	TM520ZO	
440cc	Z440A	80-82	530	104	ZO	TM530ZO
	Z440B	80	530	100	ZO	TM530ZO
	Z440H(H1-H2)	82-83	530	102	ZO	TM530ZO
	Z440LTD	82-85	530	104	ZO	TM530ZO
500cc	Z500(B1-B2)	79-80	530	100	ZO	TM530ZO
	Z500(B3-B4)	81-82	530	100	ZO	TM530ZO
	ZZR500	90-91	530	110	ZO	TM530ZO
550cc	GPZ550-A	80-83	530	100	ZO	TM530ZO
	GPZ550-C LTD	80-82	530	100	ZO	TM530ZO
	GPZ550-D1	80-81	530	100	ZO	TM530ZO
	GPZ550-H	82	530	104	ZO	TM530ZO
	Z550B(B1)	81	530	100	ZO	TM530ZO
Z550B(B2-B3)	82-83	530	100	ZO	TM530ZO	
600cc	GPX600R	87-89	530	102	ZO	TM530ZO
	GPZ600A NINJA 600	85-87	530	102	ZO	TM530ZO
	ZZ-R600	90-94	530	110	ZO	TM530ZO
	ZZ-R600	95-03	530	112	ZO	TM530ZO
	ZZ-R600	07	530	108	ZO	TM530ZO
	KLR600 A-B	84-91	520	104	ZO	TM520ZO
	ZX-6R	-02	525	108	ZO	TM525ZO
	ZX-6R	02-03	520	108	ZO	TM520ZO
	ZX-6R	05-06	520	110	ZO	TM520ZO
	ZX-6R	07-09	520	112	ZO	TM520ZO
	ZX-6RR	-04	520	108	ZO	TM520ZO
	ZX-6RR	05-	520	110	ZO	TM520ZO
	ER-6N/F	07-09	520	114	ZO	TM520ZO
650cc	KLR650A	87-00	520	106	ZO	TM520ZO
	KLR650B TENGAI	90-92	520	106	ZO	TM520ZO
	Z650(B1-B3)	77-78	530	102	ZO	TM520ZO
	Z650(C1-C3)	78-79	530	102	ZO	TM520ZO
	Z650(D1-D3)	79-80	530	102	ZO	TM530ZO
	Z650D SR	78-79	530	102	ZO	TM530ZO
	Z650F	80-82	530	102	ZO	TM530ZO
	Z650SR	82	530	104	ZO	TM530ZO
W650	99-97	525	104	ZO	TM525ZO	
750cc	GPX750R	86-87	530	110	ZO	TM530ZO
	GPX750R	84-87	530	112	ZO	TM530ZO
	ZX-7R NINJA	96-02	530	110	ZO	TM530ZO
	ZX-7RR NINJA	96-01	525	108	ZO	TM525ZO
	ZXR750	89-90	530	112	ZO	TM530ZO
	ZXR750	91-95	530	110	ZO	TM530ZO
	ZXR750R	91	530	110	ZO	TM530ZO
	ZXR750R	92-95	530	108	ZO	TM530ZO
900cc	ZX-9R(ZX900B1-B3)	94-96	530	112	ZO	TM530ZO
	ZX-9R(ZX900B4)	97	530	112	ZO	TM530ZO
	ZX-9R (ZX900C1-E2)	98-02	530	112	ZO	TM530ZO
	GPZ900R	84-89	530	112	ZO	TM530ZO
GPZ900R	90-02	530	112	ZO	TM530ZO	
DUCATI						
620cc	MONSTER	2004	520	106	ZO	TM520ZO
	MONSTER I.E.	'03-04	520	106	ZO	TM520ZO
BMW						
650cc	F650	94-95	520	110	ZO	TM520ZO
	F650 GS	99-04	520	112	ZO	TM520ZO
	F650 GS DAKAR	94	520	112	ZO	TM520ZO
	F650 ST (34 CV)	98	520	110	ZO	TM520ZO
	F650 (34 CV)	96-98	520	110	ZO	TM520ZO
CAGIVA						
	ALABLU	83	530	110	ZO	TM530ZO

cc	MODEL	YEAR	SIZE	LINK	SEAL	
					TYPE	stock no
350cc	ALAROSSA	83	530	108	ZO	TM530ZO
	ALAROSSA	86	520	108	ZO	TM520ZO
	ALAVERDE	86	530	110	ZO	TM530ZO
	ALAZZURRA	85	530	108	ZO	TM530ZO
	ELEFANT	86	520	108	ZO	TM520ZO
	T4-E	88	520	110	ZO	TM520ZO
	W12	93	520	110	ZO	TM520ZO
500cc	CANYON	98-00	520	114	ZO	TM520ZO
	PHARAON	88	520	110	ZO	TM520ZO
	T4-E	88	520	110	ZO	TM520ZO
600cc	CANYON	96-98	520	112	ZO	TM520ZO
	RIDER	95-97	520	116	ZO	TM520ZO
	W-16	95-97	520	112	ZO	TM520ZO
650cc	RAPTOR	01-04	525	112	ZO	TM525ZO
1000cc	V-RAPTOR1000	00-04	530	106	ZO	TM530ZO
GILERA						
125cc	TOP RALLY	89	520	114	ZO	TM520ZO
350cc	DAKOTA	85	520	108	ZO	TM520ZO
	ER-DAKOTA	87	520	108	ZO	TM520ZO
	XR-T	88	520	112	ZO	TM520ZO
500cc	DAKOTA	85	520	106	ZO	TM520ZO
	ER-DAKOTA	87	520	106	ZO	TM520ZO
600cc	COBRA	91	520	110	ZO	TM520ZO
	NORD WEST	91-93	520	108	ZO	TM520ZO
	RC	89	520	108	ZO	TM520ZO
	RC	90	520	108	ZO	TM520ZO
	RC	91-93	520	110	ZO	TM520ZO
	RC R	91	520	112	ZO	TM520ZO
	RC R	93	520	112	ZO	TM520ZO
XR-T	88	520	106	ZO	TM520ZO	

BEARINGS



MODEL		STEERING HEAD	SWING ARM	SWING ARM with COLLAR	FRONT WHEEL	REAR WHEEL	CRANKSHAFT
			HONDA				
C50/70/90	ALL	SSH050					
CRF50F	04-06	SSH200			WBK-197		
CRF50F	07-09	SSH200					
MBX50	84-86	SSH200					
MB5S 50	82	SSH200					
MR50/K1	74-75	SSH200					
MT50Z	80-92	SSH200					
Z50A	91-96	SSH200					
CR60R	83	SSH200					
ATC70					WBK-010	WBK-029	
ATC70	78-85				WBK-012	WBK-031	
ATC70K1					WBK-011	WBK-030	
CRF70F	04-06	SSH200			WBK-197	WBK-020	
CRF70F	07-09	SSH200					
CT70H/HK1	70-73	SSH200					
CT70/K1/K4	72-75	SSH200					
CT70	76-81	SSH200					
SL70/K1	71-73	SSH200					
ST70/K1-K3	69-73	SSH200					
XL70	74-75	SSH200					
XL75	77-79	SSH200					
XR75	76-78	SSH200					
XR75/K1/K2	73-75	SSH200					
CR80	83-84				WBK-001R	WBK-020	
CR80	85				WBK-001R	WBK-020	CBK-001
CR80	86				WBK-001R	WBK-021	CBK-001
CR80R	87-89	SSH902			WBK-001R	WBK-021	CBK-001
CR80R	90-91	SSH908			WBK-001R	WBK-021	CBK-001
CR80R	92-95	SSH908			WBK-001R	WBK-287	CBK-001
CRF80F	04-09	SSH200					
CR80R	96-02	SSH908			WBK-001R	WBK-022	CBK-001
CR85R	03-06	SSH908			WBK-001R	WBK-022	CBK-001
CR85R	07	SSH908					
CR85RB	03-05	SSH908			WBK-001R	WBK-022	CBK-001
CR85RB	07	SSH908					
MBX80RF/RS D	83	SSH200					
MTX80 C	82	SSH200					
XR80	79-84	SSH200					
XR80R	85-03	SSH200					
XL80S	80-85	SSH200					
ATC90	75	SSH200					
ATC90	76-78	SSH200			WBK-013		
ATC90	79-85	SSH200					
CT90K1-K6	69-75	SSH200					
CT90	66-68	SSH200					
CT90	76-79	SSH200					
SL90	69	SSH200					
CB100(K1/K2/K3)	76-78	SSH200					
XL100/K1	74-75	SSH200					
XL100	76-78	SSH200					
XL100S	79-80	SSH200					
XL100S	81-82	SSH200					
XL100S	83-85	SSH200					
XR100	81-82	SSH200					
XR100	83-84	SSH200					
XR100R	85-00	SSH200			WBK-001R	WBK-020	
XR100R	01-03	SSH200			WBK-001R	WBK-020	
CFR100F	04-05	SSH200			WBK-001R	WBK-020	CBK-002
CRF100F	06	SSH200			WBK-197	WBK-020	CBK-002
CRF100F	07-08	SSH200					
ATC110	79-81	SSH200			WBK-014	WBK-032	
ATC110	82-83	SSH200			WBK-015	WBK-032	
ATC110	84-85	SSH200			WBK-015	WBK-033	
CT110	80-84	SSH200					

MODEL		STEERING HEAD	SWING ARM	SWING ARM with COLLAR	FRONT WHEEL	REAR WHEEL	CRANKSHAFT
ATC125M	84-85				WBK-015	WBK-033	
ATC125M	86-87				WBK-015	WBK-034	
CB125/S/S1/S2	73-75	SSH200					
CB125T/J	78-81	SSH200					
CB125S	76	SSH200					
CB125S	78-82	SSH200					
CB125	84-85	SSH200					
CG125	77-84	SSH200					
CM125T/TZ	82-85	SSH200					
CR125M/M1	74-75	SSH200					
CR125M	76-78	SSH200					
CR125R	82-83	SSH902					
CR125R	84	SSH902R				WBK-027	
CR125R	85-86	SSH902R			WBK-002	WBK-027	
CR125R	87-88	SSH902R			WBK-002	WBK-023	CBK-003
CR125R	89	SSH902R			WBK-002	WBK-024	CBK-003
CR125R	90-92	SSH904			WBK-002	WBK-025	CBK-003
CR125R	93-94	SSH905			WBK-002	WBK-025	CBK-003
CR125R	95-97	SSH907			WBK-003	WBK-025	CBK-003
CR125R	98-99	SSH905			WBK-003	WBK-025	CBK-003
CR125R	00-06	SSH905			WBK-003	WBK-026	CBK-003
CR125R	07	SSH905					
CT125	77	SSH200					
CT125	87-89	SSH200					
FES125 PANTHEON	98-05	SSH250					
MBX125	84-85	SSH200					
MT125	74-76	SSH200					
NS125RK		SSH200					
NSR125 (ITALY)	97-00	SSH500					
TL125/K1/K2/S	73-76	SSH200					
XL125K/K1	74-75	SSH200					
XL125S	76-85	SSH200					
XR125L	03-06	SSH908					
CRF150F	08-09	SSH908					
CRF150R	08-09	SSH908					
FES150 PANTHEON	98-05	SSH250					
ATC185	80	SSH200			WBK-015	WBK-035	
ATC185S	81-83	SSH200			WBK-015	WBK-035	
CM185T	78-79	SSH200					
XR185	79	SSH200					
XL185S	79-83	SSH200					
ATC200	79-80	SSH200					
ATC200	81-83	SSH200			WBK-015		
ATC200E	82-83	SSH200			WBK-015	WBK-033	
ATC200ES	84				WBK-015		
ATC200M	84-85				WBK-015	WBK-033	
ATC200S	84-86				WBK-015	WBK-033	
ATC200X	83-85				WBK-015	WBK-033	
ATC200X	86-87				WBK-015	WBK-038	
TRX200	84				WBK-004		
TRX200	90-91				WBK-006		
TRX200D	91-94				WBK-006		
TRX200SX	86-88				WBK-005		
XL200R	83	SSH902			WBK-285	WBK-040	
XR200R	81-87	SSH902	SAB-110		WBK-285	WBK-040	
XR200R	88-02	SSH908	SAO-106		WBK-285	WBK-040	
CRF230F	08-09	SSH908					
CB250T1/T2					WBK-102		
CB250N	79				WBK-102		
CB250N A	80	SSH750			WBK-102		
CB250N B	81						
CB250ND C	82	SSH750			WBK-102	WBK-369	
CB250RS	80-84	SSH750					
CB250 NIGHTHAWK	91-93	SSH200			WBK-101	WBK-039	
CB250 TWO FIFTY	96-00	SSH200			WBK-019	WBK-039	
CB250	01-04	SSH200			WBK-019	WBK-039	
CB250	00-08	SSH200					
CBX250RS	84-86	SSH750					
CBX250F	85	SSH200					
CM250T	80-83	SSH200					
CM250C C	82-83	SSH200			WBK-101	WBK-039	
CMX250	85-87	SSH200			WBK-019		

MODEL		STEERING HEAD	SWING ARM	SWING ARM with COLLAR	FRONT WHEEL	REAR WHEEL	CRANKSHAFT
CMX250	88-04	SSH200					
CMX250C	08-09	SSH200					
CR250	83	SSH902				WBK-027	
CR250	84	SSH902R				WBK-027	CBK-004
CR250	85-86	SSH902R			WBK-002	WBK-027	CBK-004
CR250	87-88	SSH902R			WBK-002	WBK-023	CBK-004
CR250	89	SSH902R			WBK-002	WBK-024	CBK-004
CR250R	90-91	SSH904			WBK-002	WBK-025	CBK-004
CR250R	92-94	SSH905			WBK-002	WBK-025	CBK-005
CR250R	95-96	SSH907			WBK-003	WBK-025	CBK-005
CR250R	97-99	SSH905			WBK-003	WBK-025	CBK-005
CR250R	00-06	SSH905			WBK-003	WBK-026	CBK-005
CR250R	07-08	SSH905			WBK-003	WBK-026	
CRF250R	04-06	SSH905			WBK-003	WBK-026	
CRF250R	07-09	SSH905			WBK-003	WBK-026	
CRF250R	10	SSH910					
CRF250X	04-09	SSH905					
FES250 FORESIGHT	98-05	SSH250					
MVX250	83-84	SSH750					
NSR250R/F	89-93	SSH903R					
NX250 J/K/L	88-90	SSH902R					
TRX250	87				WBK-004		
TRX250	88				WBK-007		
TRX250	97				WBK-006		
TRX250	85-86				WBK-004	WBK-028	
TRX250R	87				WBK-004		
TRX250R	88-89				WBK-007		
VTR250	89-91	SSH903					
VT250L	90	SSH902R					
XL250S	79-81	SSH500		SNB-103	WBK-285	WBK-040	
XL250R	82-83	SSH902	SAB-110		WBK-285	WBK-283	
XL250R	84-87	SSH902	SAB-110		WBK-285	WBK-283	
XL250R J/K/L	88-90	SSH902	SAO-106				
XR250	79-80	SSH500			WBK-285	WBK-040	
XR250L	91-96	SSH908			WBK-096		
XR250R	81-82	SSH902			WBK-095	WBK-040	
XR250R	84-85	SSH902	SAB-110		WBK-096	WBK-040	
XR250R	86-87	SSH902	SAB-110		WBK-096	WBK-105	
XR250R	88-95	SSH908	SAO-106		WBK-096	WBK-105	
XR250R	96-04	SSH908			WBK-096	WBK-352	
TRX300	88-92				WBK-008		
TRX300	93-96				WBK-009		
TRX300EX	93-95				WBK-007		
CB350/K2-K4	69-72	SSH750			WBK-101		
CB350K5					WBK-101	WBK-363	
CB350G	73	SSH750			WBK-017	WBK-363	
CB350F/F1	73-74	SSH750		SNB-102	WBK-017	WBK-363	
XL350	76	SSH200			WBK-075		
XL350R	84-85	SSH902	SAB-110		WBK-096	WBK-283	
XR350R	83	SSH902	SAB-110		WBK-095	WBK-040	
XR350R	84	SSH902	SAB-110		WBK-096	WBK-040	
XR350R	85	SSH902	SAB-110		WBK-096	WBK-105	
CB360G	75	SSH750		SNB-102	WBK-017	WBK-363	
CJ360T	76	SSH750		SNB-102	WBK-101	WBK-363	
CB400 SUPER F.	92-97				WBK-099		
CB400F	75-77	SSH750			WBK-017	WBK-363	
CB400A	78	SSH750			WBK-102		
CB400TI	78	SSH750					
CB400TII	79	SSH750			WBK-102		
CB400T	80-81	SSH750			WBK-102	WBK-115	
CB400TZ1					WBK-101		
CB400N	79-80	SSH750			WBK-102		
CB400N C	82	SSH750			WBK-102	WBK-369	
CB1 CB400F	89-91	SSH903R			WBK-006		
CM400A	79	SSH750			WBK-102		
CM400A	80-81	SSH750			WBK-102	WBK-365	
CM400C	81	SSH750			WBK-102	WBK-365	
CM400E	80-81	SSH750			WBK-101		
CM400T	79	SSH750			WBK-102		
CM400T	80-81	SSH750			WBK-102	WBK-365	
CBR400R	87	SSH903					
CBR400RR	88-89	SSH903R					

MODEL		STEERING HEAD	SWING ARM	SWING ARM with COLLAR	FRONT WHEEL	REAR WHEEL	CRANKSHAFT
NS400R F/G	85-86	SSH903R					
VFR400ZG/PG	90-92	SSH903R					
XR400R	96-04	SSH902R					
CB450K1	68	SSH750		SNB-102	WBK-103	WBK-042	
CB450K3-K7	70-74	SSH750		SNB-102	WBK-313	WBK-042	
CB450	77				WBK-075	WBK-042	
CB450T	82	SSH750			WBK-102	WBK-365	
CB450SC	82-86	SSH750			WBK-102	WBK-111	
CM450A	82	SSH750			WBK-102	WBK-365	
CM450A	83	SSH750			WBK-102		
CM450C	82	SSH750			WBK-102	WBK-365	
CM450E	82-83	SSH750			WBK-101		
CMX450	86-87	SSH903			WBK-019	WBK-158	
CRF450X	09	SSH905					
CRF450R	02-05	SSH905			WBK-003	WBK-026	
CRF450R	06-08	SSH905			WBK-003	WBK-026	
CRF450R	09-10	SSH910					
CB500	70-74	SSH750			WBK-017	WBK-042	
CB500T	75-76	SSH750		SNB-102	WBK-017	WBK-042	
CB500	94-96	SSH903R			WBK-019	WBK-111	
CB500	97	SSH903R	SAO-102	SWS-103	WBK-019	WBK-288	
CB500	98-00	SSH903R	SAO-102	SWS-103	WBK-019	WBK-289	
CB500	02	SSH903R	SAO-102	SWS-103	WBK-019	WBK-290	
CB500S	98-00	SSH903R	SAO-102	SWS-103	WBK-019	WBK-289	
CB500S	02	SSH903R	SAO-102	SWS-103	WBK-019	WBK-290	
CR500	85-86	SSH902RR			WBK-002	WBK-027	CBK-004
CR500	87	SSH902RR			WBK-002	WBK-023	CBK-004
CR500	88	SSH902RR			WBK-002	WBK-024	CBK-004
CR500	89	SSH902RR			WBK-002		CBK-004
CR500R	90-94	SSH904			WBK-002	WBK-025	CBK-004
CR500R	95-00	SSH904			WBK-003	WBK-025	CBK-004
CR500R	01	SSH904					
CX500	78-79	SSH750			WBK-102	WBK-075	
CX500C A/B/C	80-82	SSH750			WBK-102	WBK-075	
CX500D A	80	SSH750			WBK-102	WBK-075	
CX500TC C	82	SSH903					
FT500C	82	SSH750	SAO-106		WBK-102	WBK-155	
FT500	83	SSH750			WBK-102	WBK-155	
GB500	89-90	SSH750			WBK-102	WBK-117	
GL500/I	81-82	SSH750			WBK-018	WBK-075	
GL500D C	82	SSH750					
VF500C	84-85	SSH903R			WBK-019	WBK-111	
VF500F E/F	84-85	SSH903R			WBK-019	WBK-155	
VF500FII E	84	SSH903R			WBK-019		
VT500C D	83	SSH750			WBK-019	WBK-239	
VT500C	85-86	SSH903R			WBK-019	WBK-239	
VT500E	83	SSH750			WBK-102	WBK-239	
VT500E	84-85	SSH750					
VT500FT	84	SSH750					
XL500S	79	SSH500		SNB-103	WBK-285	WBK-040	
XL500S	80-81	SSH500			WBK-285	WBK-040	
XL500R C	82	SSH902			WBK-095	WBK-283	
XR500	79-80	SSH500			WBK-285	WBK-040	
XR500R	81-82	SSH902			WBK-095	WBK-040	
XR500R	83-84	SSH902			WBK-096	WBK-040	
CB550SC	83	SSH750			WBK-019	WBK-075	
CB550F	75-77	SSH750			WBK-017	WBK-042	
CB550/K1	74-76	SSH750			WBK-017	WBK-042	
CB550K	77-78	SSH750			WBK-017	WBK-042	
CBX550F	82	SSH750					
CB600F HORNET	98-01	SSH903R			WBK-250	WBK-362	
CB600F HORNET	02-04	SSH903R			WBK-217	WBK-362	
CB600F HORNET	05-06	SSH903R			WBK-217	WBK-362	
CB600F	07-08	SSH903R			WBK-217	WBK-223	
CB600F	09	SSH903R					
CB600FA	07-09	SSH903R					
CB600F2 HORNET S	01	SSH903R			WBK-250	WBK-362	
CB600F2 HORNET S	02	SSH903R					
CBF600N/NA	04-06	SSH903R			WBK-217	WBK-223	
CBF600N/NA	07-09	SSH903R					
CBF600S/SA	04-06	SSH903R			WBK-217	WBK-223	
CBF600S/SA	07-09	SSH903R					

MODEL		STEERING HEAD	SWING ARM	SWING ARM with COLLAR	FRONT WHEEL	REAR WHEEL	CRANKSHAFT
CBR600F	87-90	SSH903R	SAO-102	SWS-103	WBK-099	WBK-155	
CBR600F	91-94	SSH903R	SAO-102	SWS-103	WBK-099	WBK-220	
CBR600F	95-96	SSH903R	SAO-115	SWS-104	WBK-006	WBK-221	
CBR600F	97-98	SSH903R	SAO-115	SWS-104	WBK-250	WBK-223	
CBR600F	99-00	SSH903R	SAO-118		WBK-213	WBK-223	
CBR600F	01-06	SSH903R			WBK-217	WBK-247	
CBR600F2	91-94				WBK-099	WBK-220	
CBR600F3	95-96				WBK-006	WBK-221	
CBR600F3	97-98				WBK-250	WBK-223	
CBR600F4	99-00	SSH903R	SAO-118		WBK-213	WBK-223	
CBR600F4	01-03	SSH903R			WBK-217	WBK-247	
CBR600FR	02	SSH903R			WBK-217	WBK-247	
CBR600FS	01-02	SSH903R			WBK-217	WBK-247	
CBR600SE	98				WBK-250	WBK-223	
CBR600SJR	96				WBK-006	WBK-221	
CBR600RR	03-04	SSH903R			WBK-273	WBK-390	
CBR600RR	07-09	SSH903R			WBK-393	WBK-390	
CBR600RR	10	SSH903R					
CBR600RA ABS	09-10	SSH903R					
VT600C	88-99	SSH903R	SAO-116		WBK-099	WBK-111	
VT600C	00-04	SSH903R					
VT600CD	95-98	SSH903R	SAO-116		WBK-099	WBK-111	
VT600CD	99-04	SSH903R					
VT600CD2	99-00	SSH903R					
XL600L D	84	SSH902R	SAB-110				
XL600R	83-87	SSH902R	SAB-110		WBK-096		
XL600V TRANSALP	87	SSH902R	SAO-108		WBK-096	WBK-283	
XL600V TRANSALP	88-90	SSH902R	SAO-108		WBK-096	WBK-283	
XL600V TRANSALP	91-96	SSH902R	SAO-108		WBK-096	WBK-284	
XL600V TRANSALP	97-99	SSH902R	SAO-108		WBK-281	WBK-282	
XR600R	85-87	SSH902R	SAB-110		WBK-096	WBK-157	
XR600R	88-91	SSH902R	SAO-106		WBK-096	WBK-157	
XR600R	92	SSH902R	SAO-106		WBK-096	WBK-105	
XR600R	93-00	SSH902R	SAO-106		WBK-097	WBK-105	
CB650	79-81	SSH750			WBK-018	WBK-156	
CB650C	80-81	SSH750			WBK-018	WBK-156	
CB650C	82				WBK-018	WBK-156	
CB650SC	82	SSH750					
CB650SC	83	SSH750			WBK-019	WBK-119	
CB650SC	84-85				WBK-019	WBK-119	
CBX650SC	83	SSH750					
CBX650E	83	SSH750					
CX650T	83	SSH903			WBK-019	WBK-118R	
CX650E	83	SSH750					
CX650C	83	SSH750			WBK-019	WBK-119	
GL650/1	83	SSH750			WBK-019	WBK-119	
GL650D	83	SSH750					
NTV650	88	SSH903					
NT650	88-89	SSH903R	SAO-103		WBK-099		
NT650	90	SSH903R			WBK-099		
NT650	91				WBK-099		
NT650	98-00	SSH903					
NT650V	01-05	SSH903R			WBK-378	WBK-112	
NX650	88-89	SSH902R	SAO-106		WBK-096	WBK-284	
NX650	90-94	SSH902R	SAO-106		WBK-096	WBK-284	
NX650 DOMINATOR	95-99	SSH902R			WBK-096	WBK-284	
SLR650	97	SSH902R					
XR650	88	SSH902R	SAO-108		WBK-096	WBK-284	
XR650	89	SSH902R	SAO-108				
XR650L	93-96	SSH902RR	SAO-106		WBK-097	WBK-040	
XR650L	97-05	SSH902RR			WBK-097	WBK-040	
XR650L	09	SSH908					
XR650R	00-06	SSH904			WBK-097	WBK-286	
XR650R	07	SSH904					
XL650V TRANSALP	00-04	SSH902R	SAO-120		WBK-281	WBK-282	
XL650V TRANSALP	06	SSH902R	SAO-120		WBK-281	WBK-374	
CB700SC	84-86	SSH903			WBK-019	WBK-152	
NSA700A	09	SSH903R					
NT700V	06-10	SSH903R					
NT700VA ABS	06-10	SSH903R					
VR700F	84-85				WBK-019	WBK-114	
VF700S	84-85	SSH903R			WBK-019	WBK-119	
VF700C	84-85	SSH903					
VF700C	86-87	SSH903					

MODEL		STEERING HEAD	SWING ARM	SWING ARM with COLLAR	FRONT WHEEL	REAR WHEEL	CRANKSHAFT
VFR700F/F2	86-87	SSH903R			WBK-099	WBK-121	
VT700C	84-85	SSH750					
VT700C	86-87	SSH903			WBK-019	WBK-152	
XL700V	08-09	SSH902R					
XL700VA	08-09	SSH902R					
CB750K1-K6	69-76	SSH750		SNB-104	WBK-017	WBK-156	
CB750K7	77	SSH750			WBK-017	WBK-041	
CB750F1/F2	77-78	SSH750		SNB-104	WBK-018	WBK-041	
CB750A	76-78	SSH750			WBK-018	WBK-156	
CB750K Z	79	SSH901		SNB-105	WBK-018	WBK-156	
CB750K A/B	80-81	SSH903			WBK-018	WBK-156	
CB750FZ	79	SSH901		SNB-105	WBK-018	WBK-041	
CB750F A/B/C	80-82	SSH903	SAB-101	SWS-101	WBK-018	WBK-041	
CB750FII C	82	SSH903	SAB-101	SWS-101	WBK-018	WBK-041	
CB750C	80-82	SSH903			WBK-018	WBK-156	
CB750SC	82-83				WBK-019	WBK-156	
CB750SC	84-85	SSH903R			WBK-019	WBK-152	
CB750 NIGHTHAWK	91-96				WBK-099	WBK-108R	
CB750FII SEVEN FIFTY	92-96	SSH903R	SAO-114		WBK-099	WBK-270	
CB750FII SEVEN FIFTY	97-99	SSH903R	SAO-114	SWS-102	WBK-099	WBK-270	
CB750FII SEVEN FIFTY	00-01	SSH903R	SAO-114	SWS-102			
CBX750F(2F)	85	SSH903R					
CBX750F E	84	SSH903R					
VF750C	82-83	SSH903			WBK-019	WBK-119	
VF750C	84	SSH903					
VF750C	88	SSH903			WBK-019	WBK-152	
VF750C	93	SSH903R					
VF750C	94-96	SSH903R	SAO-114	SWS-102	WBK-006	WBK-230	
VF750C	97	SSH903R	SAO-114		WBK-099	WBK-230	
VF750C	98-00	SSH903R	SAO-114		WBK-212	WBK-230	
VF750C	01-02	SSH903R			WBK-212	WBK-230	
VF750C2	98-00	SSH903R			WBK-212	WBK-230	
VF750C2	01-02	SSH903R			WBK-212	WBK-230	
VF750CD	95-96	SSH903R	SAO-114	SWS-102	WBK-006	WBK-230	
VF750F	83-84	SSH903			WBK-019	WBK-114	
VF750F	85	SSH903					
VF750S	82-83	SSH903			WBK-019	WBK-119	
VFR750F	86-89	SSH903R	SAO-103		WBK-099	WBK-121	
VFR750F	90-95	SSH903R	SAO-112		WBK-006		
VFR750F	96-97	SSH903R	SAO-112		WBK-006		
VT750	97-99	SSH903R					
VT750C	83	SSH750			WBK-019		
VT750C	84-85	SSH750			WBK-019		
VT750C	97-01	SSH903R	SAO-113		WBK-212	WBK-231	
VT750C	05-09	SSH903R			WBK-213	WBK-376	
VT750C2	97	SSH903R	SAO-113				
VT750C2	98-01	SSH903R	SAO-113		WBK-212	WBK-231	
VT750C2F	07-09	SSH903R					
VT750C3	01	SSH903R	SAO-113		WBK-212	WBK-231	
VT750CA	06	SSH903R			WBK-213	WBK-376	
VT750CA	07-09	SSH903R			WBK-213	WBK-376	
VT750CD	98-99	SSH903R			WBK-212	WBK-231	
VT750CD2	98-99	SSH903R			WBK-212	WBK-231	
VT750CD3	01	SSH903R			WBK-212	WBK-231	
VT750DC	01-02	SSH903R	SAO-113		WBK-212	WBK-231	
VT750DCB/A	03	SSH903R	SAO-113		WBK-212	WBK-231	
VT750DCA	05-07	SSH903R					
VT750DCB	05-07	SSH903R					
XRV750 africa twin	90-92	SSH902R			WBK-306	WBK-356	
XRV750 africa twin	93-00	SSH902R	SAO-117		WBK-306	WBK-356	
XLV750R	85	SSH902R					
PC800C	89-98	SSH903					
VFR800	02-06	SSH903R	SAO-111		WBK-213		
VFR800	07-09	SSH903R					
VFR800FI	98-02	SSH903R	SAO-111		WBK-213		
VFR800A ABS	02	SSH903R	SAO-111		WBK-213		
VFR800A ABS	03-05	SSH903R	SAO-111		WBK-213		
VFR800A ABS	06	SSH903R	SAO-111		WBK-213		
VFR800A ABS	07-09	SSH903R			WBK-213		
VT800C	88	SSH903R			WBK-019	WBK-152	
VT800C	89	SSH903R					
CB900C	80-82	SSH903			WBK-018	WBK-043	
CB900F Z	79	SSH901		SNB-105	WBK-018	WBK-041	

MODEL		STEERING HEAD	SWING ARM	SWING ARM with COLLAR	FRONT WHEEL	REAR WHEEL	CRANKSHAFT
CB900F A/B	80-81	SSH903	SAB-101	SWS-101	WBK-018	WBK-041	
CB900F C	82	SSH903	SAB-101	SWS-101	WBK-019	WBK-041	
CB900FII B	81	SSH903	SAB-101	SWS-101			
CB900FII C	82	SSH903	SAB-101	SWS-101	WBK-018	WBK-041	
CB900F HORNET	02-03	SSH903R	SAO-119		WBK-217	WBK-223	
CB900F	04-07	SSH903R	SAO-119		WBK-217	WBK-223	
CBR900RR FIREBLADE	92	SSH903R	SAO-112		WBK-099	WBK-222	
CBR900RR FIREBLADE	93-94	SSH903R	SAO-112		WBK-099	WBK-222	
CBR900RR FIREBLADE	95	SSH903R	SAO-112		WBK-006	WBK-221	
CBR900RR FIREBLADE	96-97	SSH903R	SAO-112		WBK-006	WBK-223	
CBR900RR FIREBLADE	98-99	SSH903R	SAO-112		WBK-213	WBK-223	
CBR900RR FIREBLADE	00-03	SSH903R			WBK-211	WBK-225	
CBR900RE	01	SSH903R			WBK-211	WBK-225	
CB1000F	93-95	SSH903R			WBK-006	WBK-114	
CB1000R	09	SSH903R					
CBF1000F	06-07	SSH903R					
CBF1000F	08-09	SSH903R					
CBF1000F ABS	06-07	SSH903R					
CBF1000A ABS	06-09	SSH903R					
CBF1000S	07-09	SSH903R					
CBR1000F	87-88	SSH903R	SAO-102	SWS-103	WBK-099	WBK-121	
CBR1000F	89	SSH903R	SAO-102	SWS-103			
CBR1000F	90-95	SSH903R	SAO-102	SWS-103	WBK-006	WBK-114	
CBR1000F	96	SSH903R			WBK-006	WBK-114	
CBR1000RR	04-07	SSH903R			WBK-211	WBK-390	
CBX1000	79	SSH901		SNB-105	WBK-018	WBK-041	
CBX1000	80	SSH903			WBK-018	WBK-041	
CBX1000	81-82	SSH903			WBK-018	WBK-041	
CBX1000C	83	SSH903					
GL1000	75-76	SSH750					
GL1000/K	76-77				WBK-017	WBK-043	
GL1000K	78-79				WBK-018	WBK-043	
GL1000L	76	SSH750			WBK-017	WBK-043	
VF1000F E/F/G	84-86	SSH903R			WBK-019	WBK-121	
VF1000F2	85-86				WBK-019	WBK-121	
VF1000R	85-86	SSH903R			WBK-019	WBK-123	
VTR1000F FIRE STORM	97	SSH903R	SAO-111				
VTR1000F FIRE STORM	98-03	SSH903R	SAO-111		WBK-250	WBK-223	
VTR1000F FIRE STORM	04-06	SSH903R	SAO-111		WBK-250	WBK-223	
VTR1000SP	00-01				WBK-273	WBK-225	
VTR1000SP	02-06				WBK-273	WBK-225	
XL1000V VARADERO	99-01	SSH903R	SAO-111				
XL1000V VARADERO	02-03	SSH903R	SAO-111				
XL1000V	07-09	SSH903R					
XL1000VA	04-09	SSH903R					
CB1100RII	81-83	SSH903					
CB1100F	83	SSH903			WBK-019	WBK-114	
CB1100SF	97-00	SSH903					
CBR1000F H/J	87-88	SSH903R	SAO-102				
CBR1100XX SUPER BLA	97-98	SSH903R	SAO-112		WBK-250	WBK-114	
CBR1100XX SUPER BLA	99-06	SSH903R	SAO-112		WBK-213	WBK-114	
GL1100	80-82	SSH903			WBK-018	WBK-043	
GL1100	83	SSH903			WBK-019	WBK-044	
GL1100A	82	SSH903			WBK-018	WBK-043	
GL1100A	83	SSH903			WBK-019	WBK-044	
GL1100I	80-82	SSH903			WBK-018	WBK-043	
GL1100I	83	SSH903			WBK-019	WBK-044	
GL1100D	80-81	SSH903					
ST1100	90-96	SSH903R			WBK-099	WBK-112	
ST1100	97-02	SSH903R			WBK-212	WBK-112	
ST1100A	92-94	SSH903R					
ST1100A	95-96	SSH903R			WBK-099	WBK-112	
ST1100A	97-02	SSH903R			WBK-212	WBK-112	
VF1100S	84-85	SSH903R			WBK-019	WBK-044	
VF1100C	83-86	SSH903R			WBK-019	WBK-044	
VT1100	98-00	SSH903R					
VT1100C	85-86	SSH903R			WBK-019	WBK-152	
VT1100C	87-97	SSH903R			WBK-099	WBK-152	
VT1100C	98-00	SSH903R			WBK-212	WBK-152	
VT1100C	01-04	SSH903R			WBK-212	WBK-152	
VT1100CII	95-97	SSH903R			WBK-099	WBK-112	
VT1100CII	98-03	SSH903R			WBK-212	WBK-112	
VT1100CII	04-05	SSH903R			WBK-212	WBK-112	
VT1100CII-2	99				WBK-212	WBK-112	

MODEL		STEERING HEAD	SWING ARM	SWING ARM with COLLAR	FRONT WHEEL	REAR WHEEL	CRANKSHAFT
KX125C1	84	SSK906RR					
KX125D1	85	SSK906RR			WBK-164		CBK-007
KX125E1/E2	86-87	SSK906RR			WBK-164	WBK-173	CBK-007
KX125F1	88	SSK906RR			WBK-164	WBK-173	CBK-008
KX125G1	89	SSK906RR			WBK-164	WBK-173	CBK-008
KX125H1/H2	90-91	SSK906RR			WBK-164	WBK-173	CBK-008
KX125	92	SSK905			WBK-164	WBK-173	CBK-008
KX125	93	SSK905			WBK-162	WBK-173	CBK-008
KX125	94	SSK905			WBK-162	WBK-173	CBK-008
KX125	95-96	SSK905			WBK-162	WBK-173	CBK-008
KX125	97	SSK905			WBK-162	WBK-174	CBK-008
KX125	98-02	SSK905			WBK-162	WBK-174	CBK-008
KX125M1-M3	03-05	SSK905			WBK-162		CBK-008
KDX175A1-A3	80-82	SSK904R					
KE175B1-B4	76-78	SSK200					
KE175D1-D5	79-83	SSK200					
KMX200	88-92	SSK200					
KMX200A1-A3	87-89		SAO-404				
KDX200A1-A2	83-84	SSK906RR			WBK-295		
KDX200A3	85	SSK906RR	SAB-412		WBK-295		
KDX200C1-C3	86-88	SSK906RR	SAB-412		WBK-292		
KDX200E1-E3	89-91	SSK906RR	SAB-412		WBK-293	WBK-173	
KDX200E4-E6	92-94	SSK906RR	SAB-412		WBK-293	WBK-173	
KDX200H1-H10	95-05	SSK906R			WBK-293	WBK-173	
KDX200H6F	06	SSK906R			WBK-293	WBK-173	
STA/B/C	73-75	SSK100					
Z200A1-A6	77-83	SSK200					
KDX220A4-A11	97-04	SSK906R			WBK-292	WBK-173	
KDX220	05	SSK906R			WBK-292	WBK-173	
KDX220H6-H8	00-02	SSK906R			WBK-292	WBK-173	
Z250C1-C2	81-83	SSK200					
Z250G1-G2	80-84	SSK200					
EL250B1-B3	87-89	SSK400					
EL250D4-D5	93-94	SSK400			WBK-163	WBK-207	
EL250E1-E2	91-93	SSK400			WBK-193	WBK-207	
EL250F6 EL252	03	SSK400					
EX250C1/C2			SAO-402				
EX250E1-E2	86-87	SSK400	SAO-409				
EX250F2-F5	88-91	SSK400	SAB-307	SWS-401			
EX250F6-F14	92-00	SSK400	SAB-307	SWS-401	WBK-193	WBK-175	
EX250F15-F18	01-04	SSK400			WBK-193	WBK-175	
EX250F	05-07	SSK400			WBK-193	WBK-175	
EX250H1-H14	90-03	SSK400			WBK-194	WBK-175	
EX250J	08-10	SSK400				WBK-175	
EX250KAF	10	SSK400					
KL250A1-A5	78-82	SSK904R					
KL250	83-84	SSK904R					
KL250D2-D20	85-96	SSK902	SAO-404	SWS-406	WBK-296	WBK-335	
KL250D21-D22	04-05	SSK902			WBK-296	WBK-335	
KL250G4-G6	00-02	SSK902			WBK-295	WBK-370	
KL250G	09	SSK902					
KH250	76	SSK100					
KDX250A1		SSK904					
KDX250B1-B2	81-82	SSK906RR					
KDX250B3-B4	83-84	SSK906RR					
KDX250D1	91	SSK906R			WBK-293	WBK-173	
KDX250D2-D4	92-94	SSK906R			WBK-327	WBK-173	
KDX250F3	93	SSK906R					
KLX250E1-E3	93-95	SSK906R	SAB-412				
KLX250D1-D4	93-96	SSK906R	SAB-412				
KLX250H6F	06	SSK906R	SAB-412		WBK-327	WBK-173	
KLX250T	09-10	SSK906R					
KLX250W	09-10	SSK906R					
KX250B1	82	SSK906RR					
KX250C1	83	SSK906RR					
KX250C2	84	SSK906RR					
KX250D1	85	SSK906RR			WBK-164		
KX250D2	86	SSK906RR			WBK-164	WBK-173	
KX250E1	87	SSK906RR			WBK-164	WBK-173	CBK-009
KX250F1	88	SSK906RR			WBK-164	WBK-173	CBK-009
KX250G1	89	SSK906RR			WBK-164	WBK-173	CBK-009
KX250H1/H2	90-91	SSK906RR			WBK-164	WBK-173	CBK-009

MODEL		STEERING HEAD	SWING ARM	SWING ARM with COLLAR	FRONT WHEEL	REAR WHEEL	CRANKSHAFT
KX250	92	SSK905			WBK-164	WBK-173	CBK-009
KX250	93-96	SSK905			WBK-162	WBK-173	CBK-009
KX250	97-01	SSK905			WBK-162	WBK-174	CBK-009
KX250	02	SSK905			WBK-162	WBK-174	
KX250	03-05	SSK905			WBK-162		
KX250R6F KX50	06	SSK905			WBK-162		
KX250R7F KX50	07	SSK905			WBK-162		
KX250T6F KX50F	06	SSK905			WBK-162		
KX250F	04-09	SSK905			WBK-162		
KX250F	10-11	SSK905					
S1 250					WBK-143	WBK-089	
KLX300A2-A9	97-04	SSK906R	SAB-412		WBK-292	WBK-173	
KLX300	05	SSK906R	SAB-412		WBK-292	WBK-173	
KLX300A6F	06	SSK906R	SAB-412		WBK-327	WBK-173	
KLX300A7F	07	SSK906R					
KLF300A1/A2	86-87					WBK-085	
KLF300B1-B9	88-96					WBK-085	
KLF300C1-C8	89-96					WBK-086	
EX305B1	83	SSK100					
KZ305A1-A2		SSK100					
KZ305B2-B3	87-88	SSK100					
S2 350	72-73				WBK-143	WBK-090	
S3 400	74-75	SSK100			WBK-143	WBK-089	
KH400A3-A5	76-78	SSK100			WBK-083	WBK-092	
KZ400A1-A2	77-78	SSK100				WBK-092	
KZ400B1-B2	78-79	SSK100	SAB-401	SWS-402		WBK-092	
KZ400C1	78	SSK100	SAB-401	SWS-402		WBK-092	
KZ400D1-D4	74-77	SSK100				WBK-092	
KZ400H1	79	SSK100	SAB-401	SWS-402			
Z400J2	81	SSK400	SAO-402				
KZ400S2-S3	76-77	SSK100				WBK-092	
ZX400 D3	87				WBK-163	WBK-177	
ZX400 H1/H2	89-90				WBK-166	WBK-177	
ZX400 J1	89				WBK-166	WBK-177	
ZX400 J2	90				WBK-166	WBK-178	
ZX400L1-L5	91-95	SSK907			WBK-166	WBK-178	
ZX400L6-L9	96-99	SSK907					
KDX420B1	81	SSK906RR					
KX420A1/A2	80-81	SSK906RR					
KZ440A1-A2	80-81	SSK100	SAB-401	SWS-402		WBK-092	
KZ440A3	82	SSK100	SAO-402	SWS-402		WBK-092	
KZ440A4	83	SSK100	SAO-402	SWS-402		WBK-092	
KZ440B1-B2	80-81	SSK100	SAB-401	SWS-402		WBK-092	
KZ440D2-D3	80-81	SSK100	SAB-401	SWS-402	WBK-163	WBK-092	
KZ440D4-D5	82-83	SSK100	SAO-402	SWS-402	WBK-163	WBK-092	
KZ440D6	84				WBK-163	WBK-092	
KZ440G1	82	SSK100			WBK-163	WBK-092	
EN450A1-A6	85-90	SSK902R	SAO-402	SWS-403	WBK-163	WBK-092	
KDX450A1	82	SSK906RR					
KX450D6F	06	SSK905			WBK-162		
KLX450A	09	SSK905					
KX450F	07-09	SSK905			WBK-162		
KX450F	10-11	SSK905					
EN500A1-A7	90-96	SSK902R	SAO-402	SWS-403	WBK-163	WBK-092	
EN500C1-C5	96-00	SSK902R	SAB-413		WBK-163	WBK-092	
EN500C6-C8	01-03	SSK902R			WBK-163	WBK-092	
EN500C9	04	SSK902R			WBK-163	WBK-092	
EN500C10/C6F	05-06	SSK902R			WBK-163	WBK-092	
EN500C	07-09	SSK902R			WBK-163	WBK-092	
ER500A1-A3	97-99	SSK400	SAO-409K		WBK-193	WBK-207	
ER500C1-C5 ER-5	01-05	SSK400			WBK-193	WBK-207	
ER500D1	01	SSK400	SAO-409K	SWS-404	WBK-193	WBK-207	
EX500A1-A3	87-89	SSK400	SAO-409	SWS-404	WBK-193	WBK-092	
EX500A4-A7	90-93	SSK400	SAO-409K	SWS-404	WBK-193	WBK-092	
EX500B1-B4	88-91	SSK400	SAO-409	SWS-404	WBK-193	WBK-092	
EX500D1-D12	94-05	SSK400	SAO-409K	SWS-404	WBK-194	WBK-175	
EX500D6F	06	SSK400	SAO-409K	SWS-404	WBK-194	WBK-175	
EX500D	07-09	SSK400			WBK-194	WBK-175	

MODEL		STEERING HEAD	SWING ARM	SWING ARM with COLLAR	FRONT WHEEL	REAR WHEEL	CRANKSHAFT
EX500E1-E8	94-01	SSK400	SAO-409K	SWS-404			
EX500E9	02	SSK400	SAO-409K	SWS-404	WBK-194	WBK-175	
KX500A1	83	SSK906RR					
KX500B1	85	SSK906RR					
KX500B2	86	SSK906RR			WBK-164	WBK-173	
KX500C1	87	SSK906RR			WBK-164	WBK-173	
KX500D1	88	SSK906RR			WBK-164	WBK-173	
KX500E1-E3	89-91	SSK906RR			WBK-164	WBK-173	
KX500E4-E5	92-93	SSK906RR			WBK-164	WBK-173	
KX500E6-E8	94-96	SSK906RR			WBK-162		
KX500E9	97	SSK906RR			WBK-162	WBK-174	
KX500	98-02	SSK906RR			WBK-162	WBK-174	
KX500	03-04	SSK906RR			WBK-162	WBK-174	
KH500A8	76	SSK100			WBK-083	WBK-091	
KLE500	92-93	SSK902R					
H1/A/C 500	69-72	SSK100			WBK-142		
H1B 500	69-72	SSK100			WBK-141	WBK-091	
H1 D 500	73-75	SSK100			WBK-141	WBK-091	
Z500B4	82		SAO-402				
KZ550A1	80	SSK400	SAO-402	SWS-403			
KZ550A2-A4	81-83	SSK400	SAO-402	SWS-403	WBK-163	WBK-146	
KZ550C1-C2	80-83	SSK400	SAO-402	SWS-403			
KZ550D1	81	SSK400	SAO-402	SWS-403	WBK-163	WBK-176	
KZ550F1/F2	83-84	SSK902			WBK-163	WBK-119	
KZ550H1-H2	82-83	SSK902	SAO-413		WBK-163	WBK-177	
KZ550M1	83	SSK902R			WBK-163	WBK-119	
ZR550B1	90	SSK902	SAO-401	SWS-405	WBK-163	WBK-177	
ZR550B2-B5	91-94				WBK-163	WBK-177	
ZX550A1-A3	84-86	SSK902R	SAO-416		WBK-163	WBK-177	
ZL600A1-A2	86-87	SSK902			WBK-163	WBK-119	
ZL600B1	95	SSK902					
ZL600B2	96	SSK902			WBK-194	WBK-119	
ZL600B3	97				WBK-194	WBK-119	
KL600A1	84	SSK902	SAO-404	SWS-406	WBK-296	WBK-335	
KL600B1-B2	85-86	SSK902	SAO-404	SWS-406	WBK-296	WBK-335	
ZX600A1-A3	85-87	SSK902	SAO-418	SWS-407	WBK-163	WBK-177	
ZX600B1 NINJA	87		SAO-418	SWS-407	WBK-163	WBK-177	
ZX600C1-C2	88-89	SSK902	SAO-401	SWS-405	WBK-163	WBK-177	
ZX600C3-C9	90-96	SSK902	SAO-401	SWS-405	WBK-163	WBK-177	
ZX600C10	97	SSK902			WBK-163	WBK-177	
ZX600D1-D4	90-93	SSK902	SAO-406	SWS-408	WBK-165	WBK-177	
ZX600E1-E3	93-95	SSK902	SAO-405		WBK-166	WBK-178	
ZX600E4-E13 ZZR600	96-05	SSK902			WBK-166	WBK-178	
ZX600F1-F2	95-97	SSK902	SAO-405		WBK-166	WBK-178	
ZX600F3	98				WBK-166	WBK-178	
ZX600G1/G2	98-99	SSK908	SAO-405		WBK-195	WBK-180	
ZX600J ZZR600	00-06	SSK908	SAO-405		WBK-195	WBK-180	
ZX600J	07-08	SSK908			WBK-195	WBK-180	
ZX600K1	03	SSK907	SAO-421		WBK-195	WBK-180	
ZX600R ZX-6R	09	SSK907			WBK-195	WBK-180	
ZX600R ZX-6R	10	SSK907					
ZX600N1-N6F ZX-6RR	05-06	SSK907			WBK-195	WBK-180	
ZX600P ZX-6RR	07-08	SSK907				WBK-180	
ZX636A1P	02	SSK908	SAO-405		WBK-195	WBK-180	
ZX636B1/B2	03-04	SSK907	SAO-421		WBK-195	WBK-180	
ZX636C1-C6F ZX-6R	05-06	SSK907			WBK-195	WBK-180	
ZX636D6F ZX-6R	06	SSK907			WBK-195	WBK-180	
EJ650A1	99	SSK902	SAO-410		WBK-294	WBK-092	
EJ650A3/A4	01-02	SSK902	SAO-410		WBK-307	WBK-092	
EJ650C5	03	SSK902	SAO-410		WBK-307	WBK-092	
EJ650C6-C7	04-05	SSK902					
ER650C	09-10	SSK907					
EX650A6F	06	SSK907			WBK-166	WBK-178	
EX650A	07-08	SSK907			WBK-166	WBK-178	
EX650C	09-10	SSK907					
KL650A1-A14	87-00	SSK902	SAO-404	SWS-409	WBK-296	WBK-336	
KL650A15-A19	01-05	SSK902	SAO-404	SWS-409	WBK-296	WBK-336	
KL650A7F	07	SSK902					
KL650A6F	06	SSK902	SAO-404		WBK-296	WBK-336	
KL650A7F	07	SSK902					
KL650B1	89	SSK902	SAO-404	SWS-409			
KL650B2-B3	90-91	SSK902	SAO-404	SWS-409	WBK-296	WBK-336	

MODEL		STEERING HEAD	SWING ARM	SWING ARM with COLLAR	FRONT WHEEL	REAR WHEEL	CRANKSHAFT
KL650C1/C2	95-03	SSK902	SAO-404		WBK-296	WBK-336	
KLR650E	08	SSK902					
KL650E	09-10	SSK902					
KLE650A	08	SSK907			WBK-166	WBK-178	
KLX650A1-A3	93-95	SSK906					
KLX650C1-C2	93-94	SSK906R					
KLX650D1/D4	96-99	SSK906R					
KZ650B1-B2	77-79	SSK400			WBK-083	WBK-146	
KZ650B3	77-79	SSK400					
KZ650C1	77	SSK400			WBK-083	WBK-208	
KZ650C2-C3	78-79	SSK400	SAB-402/SA	SWS-410	WBK-083	WBK-208	
KZ650C4	80				WBK-083	WBK-208	
KZ650D1-D2	78-79	SSK400	SAB-402/SA	SWS-410	WBK-083		
KZ650E1	80	SSK400	SAB-402/SA	SWS-410	WBK-083	WBK-147	
KZ650F1	80	SSK400	SAB-402/SA	SWS-410	WBK-083	WBK-146	
KZ650F2-F3	81-82				WBK-163	WBK-147	
KZ650H1	81	SSK400	SAB-402/SA	SWS-410	WBK-163	WBK-147	
KZ650H2	82	SSK400	SAO-402	SWS-411	WBK-163	WBK-147	
KZ650H3	83	SSK400	SAO-402	SWS-411	WBK-163	WBK-147	
KZ700A1	84				WBK-163	WBK-176	
VN700A1	85				WBK-163	WBK-119	
ZN700A1-A2	84-85				WBK-163	WBK-206	
H2/A/B/C	72-75	SSK100			WBK-141	WBK-087	
KZ750B1-B4	76-79	SSK400					
KZ750E1	80	SSK400	SAB-402/SA	SWS-410			
KZ750E2	81	SSK400	SAB-402/SA	SWS-410	WBK-163	WBK-176	
KZ750E3	82	SSK400	SAO-402	SWS-411	WBK-163	WBK-176	
KZ750F1	83	SSK902			WBK-163	WBK-206	
KZ750G1 LTD	80	SSK400	SAO-403		WBK-083	WBK-093	
KZ750H1	80	SSK400	SAB-402/SA	SWS-410	WBK-163	WBK-176	
KZ750H2-H4	81-83	SSK400	SAO-402		WBK-163	WBK-176	
KZ750K1-K2	83-84	SSK400	SAO-413	SWS-416	WBK-163	WBK-147	
KZ750L1-L2	81-82	SSK400			WBK-163	WBK-176	
KZ750L3	83	SSK902	SAO-402	SWS-411	WBK-163	WBK-176	
KZ750M1	82	SSK400	SAO-413	SWS-416	WBK-163	WBK-147	
KZ750N1-N2	82-83	SSK902			WBK-163	WBK-206	
KZ750R1	82	SSK902	SAO-402	SWS-411	WBK-163	WBK-176	
KZ750S1	82	SSK400			WBK-163	WBK-147	
VN750A2-A16	86-00	SSK902R			WBK-163	WBK-119	
VN750A17-A21	01-05	SSK902R			WBK-163	WBK-119	
VN750A6F	06	SSK902R			WBK-163	WBK-119	
ZR750C1-C3	91-94	SSK902	SAO-419	SWS-423	WBK-165	WBK-177	
ZR750C4	95	SSK902	SAO-419	SWS-423	WBK-165	WBK-177	
ZR750F1	99	SSK902	SAO-422	SWS-420	WBK-165	WBK-178	
ZR750F2-F5	00-03	SSK902	SAO-422	SWS-420	WBK-165	WBK-178	
ZR750H1-H3	01-03	SSK902			WBK-165	WBK-178	
ZR750K1	05	SSK907			WBK-301	WBK-178	
ZR750K6F Z750S	06	SSK907					
ZX750A1-A2	83-84	SSK902	SAO-420	SWS-412	WBK-163	WBK-176	
ZX750A3	85	SSK902R			WBK-163	WBK-176	
ZX750B1-B4	94-97					WBK-180	
ZX750E1-E2	84-85	SSK902	SAO-420	SWS-412	WBK-163	WBK-176	
ZX750F1-F3	87-90	SSK902	SAO-401	SWS-413	WBK-163		
ZX750F4	91	SSK902			WBK-163		
ZX750G1-G2	84-85	SSK902	SAO-415	SWS-414	WBK-163	WBK-176	
ZX750G3	86				WBK-163	WBK-176	
ZX750H1-H2	89-90	SSK902			WBK-309	WBK-379	
ZX750J1-J2	91-92	SSK907	SAO-414		WBK-167	WBK-180	
ZX750K1-K2	91-92	SSK907	SAO-414		WBK-167	WBK-180	
ZX750L1-L3	93-95	SSK907	SAO-414		WBK-167	WBK-180	
ZX750M1-M2	93-94	SSK907	SAO-414		WBK-167	WBK-180	
ZX750N1-N2	96-97	SSK907	SAO-411		WBK-167	WBK-180	
ZX750P1-P3	96-98	SSK907	SAO-411		WBK-167	WBK-180	
ZX750P4	99	SSK907			WBK-167	WBK-180	
ZX750P5	00				WBK-167	WBK-180	
VN800A1-A6	95-00	SSK902R			WBK-168	WBK-181	
VN800A7-A11	01-05	SSK902R			WBK-168	WBK-181	
VN800B1-B8	96-03	SSK902R			WBK-166	WBK-181	
VN800B9-B10	04-05	SSK902R			WBK-166	WBK-181	
VN800C1/C2	99-00	SSK902R			WBK-166	WBK-177	
VN800E1/E2	01-02	SSK902R			WBK-166	WBK-177	
VN800E6F	06	SSK902R			WBK-166	WBK-177	

MODEL		STEERING HEAD	SWING ARM	SWING ARM with COLLAR	FRONT WHEEL	REAR WHEEL	CRANKSHAFT
Z1 900	73	SSK400		SNB-406	WBK-141	WBK-087	
Z1A 900	74	SSK400		SNB-406	WBK-141	WBK-087	
Z1B 900	75	SSK400		SNB-406	WBK-141	WBK-087	
Z900A4-A5	76-77	SSK400		SNB-406	WBK-083	WBK-087	
KZ900 B1	76	SSK400			WBK-084	WBK-093	
VN900B	07-08	SSK902R				WBK-178	
VN900B	09-10	SSK902R					
VN900C	07-10	SSK902R					
VN900D	09-10	SSK902R					
ZX900A1-A8	84-91	SSK902	SAO-415	SWS-414	WBK-163	WBK-176	
ZX900B1-B4	94-97	SSK907	SAO-411		WBK-167	WBK-180	
ZX900C1-C2	98-99	SSK907	SAO-407		WBK-166	WBK-178	
ZX900E1-E2	00-01	SSK908			WBK-195	WBK-180	
ZX900F1/F2	02-03	SSK908			WBK-195	WBK-180	
KZ1000A1	77	SSK400			WBK-083	WBK-094	
KZ1000A2-A4	78-80	SSK400	SAB-402/SA	SWS-415	WBK-083	WBK-094	
KZ1000B1-B4	77-80	SSK400	SAB-402/SA	SWS-415	WBK-083	WBK-094	
KZ1000D Z1-R	78-80	SSK400	SAB-402/SA	SWS-415	WBK-083	WBK-094	
KZ1000E1/E2	79-80	SSK901			WBK-084		
KZ1000G1	80	SSK400	SAB-402/SA	SWS-415	WBK-084	WBK-094	
KZ1000H1	80				WBK-083	WBK-094	
KZ1000J1-J2	81-82	SSK902	SAO-417	SWS-416	WBK-188	WBK-202	
KZ1000J3	83	SSK902			WBK-163	WBK-202	
KZ1000K1-K2	81-82	SSK902	SAO-417	SWS-416	WBK-188	WBK-202	
KZ1000M1-M2	81-82	SSK902	SAO-417	SWS-416	WBK-163	WBK-202	
KZ1000R1	82	SSK902	SAO-417	SWS-416	WBK-188	WBK-202	
KZ1000R2	83	SSK902	SAO-417	SWS-416	WBK-163	WBK-202	
ZL1000A1	87	SSK902					
ZG1000A1-A8	86-93	SSK902			WBK-163	WBK-205	
ZG1000A9-A20	94-05	SSK902			WBK-165	WBK-205	
ZG1000A6F	06	SSK902			WBK-165	WBK-205	
ZR1000A1 Z1000	03-05	SSK907			WBK-195	WBK-180	
ZR1000A6F	06	SSK907			WBK-195	WBK-180	
ZR1000B	07-08	SSK907				WBK-180	
ZR1000D Z1000	10	SSK907					
ZX1000A1/A2	86-87	SSK902	SAO-401	SWS-417	WBK-163	WBK-202	
ZX1000B1-B3	88-90	SSK902	SAO-405	SWS-418	WBK-170	WBK-202	
ZX1000C1-C2	04-05	SSK907			WBK-166	WBK-178	
ZX1000D6F	06	SSK902			WBK-195	WBK-178	
ZX1000D7F ZX-10R	07	SSK907			WBK-195	WBK-178	
ZX1000E ZX-10R	08-09	SSK907			WBK-195		
ZX1000F NINJA ZX10R	10	SSK907					
KZ1100A1-A2	81-82	SSK902			WBK-188	WBK-205	
KZ1100A3	83	SSK902			WBK-163	WBK-205	
KZ1100B1	81	SSK902	SAO-417	SWS-416	WBK-188	WBK-202	
KZ1100B2	82	SSK902	SAO-417	SWS-416	WBK-163	WBK-205	
KZ1100D1	82	SSK902			WBK-188	WBK-205	
KZ1100D2	83	SSK902			WBK-163	WBK-205	
KZ1100L1	83	SSK902			WBK-163	WBK-205	
ZN1100B1-B2	84-85	SSK902			WBK-163	WBK-205	
ZR1100A1-A2	92-93	SSK902	SAO-406	SWS-408	WBK-165	WBK-202	
ZR1100A3	94				WBK-165	WBK-202	
ZR1100C1-C3	97-99	SSK902	SAO-408	SWS-421	WBK-167	WBK-202	
ZR1100C4	00				WBK-167	WBK-202	
ZR1100D1-D4	97-00	SSK902	SAO-408				
ZX1100A1-A2	83-84	SSK902			WBK-163	WBK-202	
ZX1100B1-B3	88-90					WBK-202	
ZX1100C1-C4	90-93	SSK901R	SAO-405	SWS-419	WBK-309	WBK-202	
ZX1100D1-D8	93-00	SSK907	SAO-405	SWS-419	WBK-167	WBK-202	
ZX1100E1-E3	95-97	SSK901R		SWS-418	WBK-165	WBK-202	
ZG1200A1	86	SSH901			WBK-163	WBK-205	
ZG1200B1-B12	87-98	SSH901			WBK-163	WBK-205	
ZR1200A1P-A3P	01-03	SSK902			WBK-167	WBK-204B	
ZR1200A5	05	SSK902			WBK-167	WBK-204B	
ZR1200B1P-B3P	01-03	SSK902			WBK-167	WBK-204B	
ZR1200C1P/C2P	01-03	SSK902			WBK-167	WBK-204B	
ZX1200A1-A2H	00-01	SSK908			WBK-195	WBK-203	
ZX1200B1-B4	02-05	SSK907			WBK-195	WBK-203	
ZX1200C1-C2 ZZR1200	02-03	SSK907			WBK-167	WBK-204B	
ZX1200C3-C4 ZZR1200	04-05	SSK907			WBK-167	WBK-204B	
ZG1300A1	84	SSK901					
ZN1300A1-A4	83-86	SSK901			WBK-172		

MODEL		STEERING HEAD	SWING ARM	SWING ARM with COLLAR	FRONT WHEEL	REAR WHEEL	CRANKSHAFT
ZN1300A5-A6	87-88	SSK901					
KZ1300A1-A3	79-81	SSK901			WBK-145		
KZ1300A4	82	SSK901			WBK-171		
ZX1400A7F	07	SSK907					
ZX1400C	08	SSK907				WBK-203	
ZX1400C	09-10	SSK907					
ZX1400D	10	SSK907					
VN1500A1-A12	87-98	SSK902R			WBK-196	WBK-205	
VN1500B1-B5	87-91	SSK902R			WBK-196	WBK-205	
VN1500B6	92				WBK-196	WBK-205	
VN1500C1-C4	94-97	SSK902R			WBK-163	WBK-205	
VN1500D1-D2	97-98	SSK902R			WBK-166	WBK-205	
VN1500E1-E3	98-00	SSK902R			WBK-166	WBK-205	
VN1500E4-E7	01-04	SSK902R			WBK-166	WBK-205	
VN1500G1/G2	98-99	SSK907			WBK-166	WBK-205	
VN1500J1-J2	99-00	SSK907			WBK-166	WBK-205	
VN1500L1-L4	00-03	SSK907			WBK-166	WBK-205	
VN1500L5	04	SSK907			WBK-166	WBK-205	
VN1500N1H/N2H/N3H	00-02	SSK907			WBK-166	WBK-205	
VN1500N6F	06	SSK907			WBK-166	WBK-205	
VN1500 N7F	07	SSK907			WBK-166	WBK-205	
VN1500P1H/P2H	02-03	SSK907			WBK-195	WBK-205	
VN1500R1H/R2H	01-02	SSK907			WBK-166	WBK-205	
VN1500T6F	06	SSK907			WBK-166	WBK-205	
VN1600A1-A3	03-05	SSK907			WBK-195	WBK-205	
VN1600A6F	06	SSK907				WBK-205	
VN1600A7F	07	SSK907					
VN1600B1-B2	04-05	SSK907				WBK-205	
VN1600B6F	06	SSK907				WBK-205	
VN1600 B7F	07	SSK907					
VN1600F6F	06	SSK907				WBK-205	
VN1600D1/D6F	05-06	SSK907				WBK-205	
VN1600 D	07-08	SSK907				WBK-205	
VN1700E	09-10	SSK907					
VN1700G	10	SSK907					
VN1600E6F	06	SSK907				WBK-205	
VN1600G6F	06	SSK907				WBK-205	
VN2000A1-A2	04-05	SSK907			WBK-195	WBK-204B	
VN2000A6F	06	SSK907			WBK-195		
VN2000 A7F	07	SSK907					
VN2000D1	05	SSK907			WBK-195	WBK-204B	
VN2000D6F	06	SSK907					
VN2000D7F	07	SSK907					
VN2000F7F	07	SSK907					
VN2000J	08-09	SSK907					
VN2000H	08	SSK907					
VN2000G	08	SSK907					
			SUZUKI				
A50	71-78	SSS100					
AP50	75-78	SSS100					
GT50KEN	79-80	SSS100					
GT50KB	77-78	SSS100					
OR50ET	80	SSS100					
RB50H	87	SSS100					
RM50	78-82	SSS100					
TS50ER	80-83	SSS100					
ZR50LKX	82-84	SSS100					
ZR50SKX/SKE/SKH	83-90	SSS100					
ZR50KEN/KEX X1	79-83	SSS100					
RM60 N-D	79-83	SSS100					
RM65	03-05	SSK904					
DS80N	92-93	SSS100					
DS80 T-W	96-98	SSS100					
RM80	77-81	SSS100					
RM80	82-85	SSS100					
RM80	90-01	SSS901			WBK-323	WBK-333	CBS-011
RM85K2/K3	02-03	SSS901			WBK-323	WBK-333	CBS-011
RM85L	02-05	SSS901			WBK-323	WBK-333	CBS-011
RM85L	06				WBK-323	WBK-333	
TS90	71-73	SSS100					

MODEL		STEERING HEAD	SWING ARM	SWING ARM with COLLAR	FRONT WHEEL	REAR WHEEL	CRANKSHAFT
A100 K-B	73-77	SSS100					
GP100	78-84	SSS100					
GP100U	79-93	SSS100					
TS100ER	76-89	SSS100					
TS100 K-C	73-78	SSS100					
B120D	71-77	SSS100					
ALT125	83-86				WBK-077	WBK-134	
DR125S Z/D/E	82-86	SSS100					
DR125	86-88				WBK-323	WBK-347	
DR125S	94-96	SSH901					
DR125SM	09	SSH901					
DR-Z125	03-05	SSS901				WBK-346	
DR-Z125	09	SSS901					
GZ125(U) W/X	98-99	SSH901					
GN125R	94-96	SSS100					
GN125E V	97	SSS100					
GN125(U/E)X/W	98-99	SSS100					
GP125C/N/X/D	78-89	SSS100					
GS125ES R	94	SSS100					
GS125ES Z-M	82-91	SSS100					
GT125 L-C	73-78	SSS100					
LT125	83-87				WBK-077		
RG125UCG/UH/UJ	85-92	SSS100					
RGV125	92-96	SSH901					
RM125	92-94	SSS904			WBK-321	WBK-342	CBK-012
RM125	95	SSS904			WBK-321	WBK-343	CBK-012
RM125	96-97	SSS904			WBK-325	WBK-343	CBK-012
RM125	98-99	SSS904			WBK-325	WBK-343	CBK-012
RM125	00	SSS904			WBK-325		CBK-012
RM125	01-04	SSS904			WBK-326		CBK-012
RM125	05				WBK-326		CBK-012
RM125	06	SSS906			WBK-326		
RM125	07-08	SSS906			WBK-326		
RV125 VAN VAN	03-10	SSH901					
TS125ER T/X	80-81	SSS100					
TS125 K-C	73-78	SSS100					
TS125 STINGER	70-73	SSS100					
TU125XT X	99	SSS100					
UH125 BURGMAN	02-09	SSH901					
UX125 SIXTEEN	08	SSH901					
VL125K5-K6	05-06	SSH901			WBK-063		
VL125K7	07	SSH901					
UH150K2-K6 BURGMAN	02-06	SSH901					
UX150 SIXTEEN	08	SSH901					
LT160E	89-92				WBK-077		
LT-F160	91-96				WBK-077		
ALT185					WBK-077	WBK-134	
GT185 K-C	73-78	SSS100					
LT185	84-86				WBK-077	WBK-134	
TS185 K-C	73-78	SSS100					
TS185ER N-X	79-81	SSS100					
AN250 X	99	SSH901					
DR200SE	96-04	SSH901			WBK-323	WBK-347	
DR200SE	09	SSH901					
DR200S J-L	88-90	SSS100					
GT200EN/EX	79-82	SSS100					
SB200EN/EX	79-83	SSS100					
UH200 BURGMAN	07-09	SSH901					
LT230E	87-93				WBK-072	WBK-135	
LT230GE	85-86				WBK-073		
LT230S	85-88				WBK-072	WBK-135	
AN250 BURGMAN	98-06	SSH901					
DR250	90-93	SSH901	SAO-310	SWS-307	WBK-149	WBK-337	
DR250	94	SSH901	SAO-310	SWS-307			
DR250S	90-92	SSH901	SAO-310	SWS-307	WBK-149		
DR250S	93-94	SSH901	SAO-310	SWS-307	WBK-149		
DR250SE	93-94	SSH901	SAO-310	SWS-307	WBK-149		
DR250SE S	95	SSH901	SAO-310	SWS-307	WBK-149		
DR-Z250	01-04	SSS904	SAO-310	SWS-307	WBK-150	WBK-337	
GN250E Z	82	SSH901					

MODEL		STEERING HEAD	SWING ARM	SWING ARM with COLLAR	FRONT WHEEL	REAR WHEEL	CRANKSHAFT
GN250E D	83	SSH901					
GN250E M/R	91-94	SSH901					
GN250 F/J	85-88	SSH901					
GN250 M-T	91-96	SSH901					
GSX250 T/X	80-81	SSS250	SAB-307				
GS250FW	85	SSS250					
GSX250E T/X	80-81	SSS250	SAB-307				
GSX250ES Z	82	SSS250	SAB-307				
GSX250E Z	82	SSS250	SAB-307				
GSX250F M-R	91-94	SSH901					
GT250 K-C	73-78	SSS250					
GT250E N-Z X7	78-83	SSS100					
GZ250	99-02	SSH901					
GZ250	03	SSH901			WBK-063		
GZ250K4-K6	04-06	SSH901			WBK-063		
GZ250	09	SSH901					
LT250EF	85-86				WBK-073		
LT250R	85-92				WBK-072	WBK-135	
LT250S	89-90				WBK-072		
LT-F250	88-96				WBK-074		
LT-F250F	99				WBK-079R		
TU250X	09	SSH901					
PE250 C/N	78-79	SSS250					
RGV250 M-R	91-94	SSH901					
RGV250 L	89	SSH901					
RM250	88	SSH901			WBK-321	WBK-358	
RM250	89	SSY901			WBK-321	WBK-358	CBK-014
RM250	90	SSY901			WBK-321	WBK-359	CBK-014
RM250	91	SSY904			WBK-321	WBK-359	CBK-014
RM250	92-93	SSS904			WBK-321	WBK-342	CBK-014
RM250	94	SSS904			WBK-321	WBK-342	CBK-016
RM250	95	SSS904			WBK-321	WBK-343	CBK-016
RM250	96-99	SSS904			WBK-325	WBK-343	CBK-017
RM250	00	SSS904			WBK-325		CBK-017
RM250	01-02	SSS904			WBK-326		CBK-018
RM250	03-04	SSS904			WBK-326		CBK-019
RM250	05				WBK-326		
RM250	06	SSS906			WBK-326		
RM250	07-08	SSS906			WBK-326		
RM-Z250	04-05	SSK905			WBK-162		
RM-Z250	06	SSK905			WBK-162		
RM-Z250	07-08	SSS904				WBK-388	
RM-Z250	09-10	SSS904					
TS250 A-C	76-78	SSS250					
TS250 R-M	71-75	SSS250					
TM250 L-M	73-75	SSS250					
TU250 W/X	98-99	SSH901					
VL250 K5-K7	05-07	SSH901					
GS300L F	84	SSS250					
GS300L Z/D	82-83	SSS250					
LT300E	87-89				WBK-073	WBK-135	
DR350	90-96	SSH901	SAO-310	SWS-307	WBK-149	WBK-337	
DR350	97-98	SSH901	SAO-310	SWS-307	WBK-150	WBK-337	
DR350	99	SSH901	SAO-310	SWS-307	WBK-150	WBK-337	
DR350S	90-93	SSH901	SAO-310	SWS-307	WBK-149		
DR350S	94-95	SSH901	SAO-310	SWS-307	WBK-149		
DR350SE	94-95	SSH901	SAO-310	SWS-307	WBK-149		
DR350SE	96	SSH901	SAO-310	SWS-307	WBK-149	WBK-337	
DR350SE	97	SSH901	SAO-310	SWS-307	WBK-149	WBK-337	
DR350SE	98	SSH901	SAO-310	SWS-307	WBK-150	WBK-337	
DR350SE	99	SSH901	SAO-310	SWS-307	WBK-150	WBK-337	
SP370 C/N	78-79	SSS250					
GT380 K-B	73-77	SSS250			WBK-075	WBK-132	
AN400X	99	SSH901					
AN400K7	07	SSH901					
AN400 BURGMAN	99-10	SSH901					
DR400S T/X	80-81	SSH901					
DR-Z400	00-05	SSS904			WBK-325	WBK-338	
DR-Z400E Y-K6	00-06	SSS904			WBK-325	WBK-338	
DR-Z400E K7	07	SSS904					
DR-Z400S Y-K6	00-06	SSS904			WBK-325	WBK-338	
DR-Z400S	07-09	SSS904					

MODEL		STEERING HEAD	SWING ARM	SWING ARM with COLLAR	FRONT WHEEL	REAR WHEEL	CRANKSHAFT
DR-Z400SM K5-K8	05-08	SSS904					
GN400T X/Z	81-82	SSH901					
GN400L T/X	80-81	SSH901					
GN400 T	80	SSH901					
GS400 B	77	SSS250				WBK-132	
GS400 C	78	SSS250	SAB-307	SWS-301		WBK-132	
GS400 N	79	SSS250	SAB-307				
GS400E C/N	78-79	SSS250	SAB-307				
GS400X	77-78					WBK-132	
GSF400 M/P	91-93	SSH901			WBK-075	WBK-242	
GSX400E	80	SSH901					
GSX400E	81	SSH901	SAB-307				
GSX400E	82-83	SSH901					
GSX400E	84-85	SSH901	SAB-307				
GSX400E	86-87	SSH901					
GSX400FE X	81	SSH901	SAB-307				
GSX400S	80-83	SSH901					
GSX400S	84-85	SSH901	SAB-307				
GSX400S	86-87	SSH901					
GSXR400F	87	SSH901					
LT4WD	96				WBK-079R		
LT4WDX	96-97				WBK-079R		
TM/TS400	73-77	SSS250					
GS425 N	79	SSS250	SAB-307	SWS-301		WBK-132	
GS425E N	79	SSS250	SAB-307	SWS-301		WBK-132	
GS425L N	79		SAB-307	SWS-301		WBK-132	
GS450 T/X	80-81	SSH901	SAB-307				
GS450E	80-81	SSH901	SAB-307	SWS-301			
GS450E	82-83	SSH901	SAB-307	SWS-301			
GS450GA Z/D	82-83	SSH901					
GS450S T/X	80-81	SSH901	SAB-307	SWS-301			
GS450T X	81	SSH901	SAB-307	SWS-301			
GS450L T-D	80-83	SSH901	SAB-307	SWS-301			
GS450L F-J	85-88	SSH901	SAB-307		WBK-075	WBK-132	
RM450Z	05-06	SSS904				WBK-388	
RM450Z	07-10	SSS904					
DR500S X/Z	81-82	SSH901					
DR500 X/Z	81-82	SSH901					
GS500E	89-00	SSH901	SAB-307	SWS-301	WBK-075	WBK-242	
GS500	01	SSH901	SAB-307	SWS-301	WBK-075	WBK-242	
GS500	02	SSH901	SAB-307	SWS-301	WBK-075	WBK-242	
GS500F	09	SSH901					
RG500 G	86	SSH901					
GT500	76-77				WBK-075	WBK-132	
LT500R	87-90				WBK-072		
GS550 B	77	SSS250	SAB-307				
GS550 C/N	78-79	SSS250	SAB-307	SWS-301			
GS550E C	78	SSS250	SAB-307	SWS-301	WBK-075	WBK-132	
GS550E N	79	SSS250	SAB-307	SWS-301	WBK-075	WBK-132	
GS550E T (SPOKE)	80	SSH901	SAB-307	SWS-301	WBK-075	WBK-132	
GS550E T (CAST)	80	SSH901	SAB-307	SWS-301	WBK-075	WBK-241	
GS550E	83-84	SSH901	SAB-308				
GS550E	85	SSH901	SAB-308		WBK-075	WBK-132	
GS550E	86	SSH901					
GS550ES	84-86	SSH901	SAB-308		WBK-075	WBK-132	
GSX550ES D-H	83-87	SSH901					
GS550D T	80	SSH901	SAB-307				
GSX550E F/G	85-86	SSH901	SAB-308		WBK-075	WBK-349	
GSX550EF F/G	85-86	SSH901	SAB-308		WBK-075	WBK-349	
GSX550ES F/G	85-86	SSH901	SAB-308		WBK-075	WBK-349	
GSX550EU F/G	85-86	SSH901	SAB-308		WBK-075	WBK-349	
GS550L N	79	SSS250	SAB-307	SWS-301	WBK-075	WBK-241	
GS550L T	80-82	SSH901	SAB-307	SWS-301	WBK-075	WBK-241	
GS550L	83	SSH901	SAB-308		WBK-075	WBK-241	
GS550L	85-86	SSH901	SAB-308		WBK-075	WBK-241	
GS550M Z	82	SSH901	SAB-307	SWS-301			
GS550T X	81	SSH901	SAB-307	SWS-301	WBK-075	WBK-241	
GT550 K-B	73-77	SSS250			WBK-075	WBK-132	
DR600S F-H	85-87		SAB-311	SWS-306			
DR600SU F-H	85-87		SAB-311	SWS-306			
DR600R G-K	86-89		SAB-311	SWS-306			

MODEL		STEERING HEAD	SWING ARM	SWING ARM with COLLAR	FRONT WHEEL	REAR WHEEL	CRANKSHAFT
DR600RU G-K	86-89		SAB-311	SWS-306			
GSF600S BANDIT	95-03	SSH901	SAB-313	SWS-305	WBK-151	WBK-226	
GSR600	06-010	SSS903R					
GSX600F	88	SSH901	SAB-307	SWS-301	WBK-075	WBK-238	
GSX600F	89-97	SSH901	SAB-307	SWS-301	WBK-075	WBK-242	
GSX600F	98-01	SSH901	SAB-307	SWS-303	WBK-075	WBK-242	
GSX600F	02	SSH901	SAB-307	SWS-303	WBK-075	WBK-242	
GSX600F	03	SSH901	SAB-307	SWS-303	WBK-324	WBK-242	
GSX600F	04-06	SSH901	SAB-307	SWS-303	WBK-324	WBK-242	
GSX-R600	97-00	SSS903	SAB-312		WBK-214	WBK-235	
GSX-R600 K1	01	SSS903	SAB-312		WBK-214	WBK-234	
GSX-R600 K2	02	SSS903	SAB-312		WBK-214	WBK-234	
GSX-R600 K3	03	SSS903	SAB-312		WBK-214	WBK-234	
GSX-R600 K4-K5	04-05	SSS903R	SAB-312		WBK-214	WBK-345	
GSX-R600 K6	06	SSS903R	SAB-310		WBK-214	WBK-345	
GSX-R600	07-08	SSS903R			WBK-214	WBK-345	
GSX-R600	09-10	SSS903R					
GSX-R600W	92-93	SSH901	SAB-308	SWS-304	WBK-152	WBK-226	
RF600R P	93	SSH901	SAB-313				
RF600R R-T	94-96	SSH901	SAB-313	SWS-305	WBK-151	WBK-226	
AN650 BURGMAN	03-10	SSH901					
DL650	04-05	SSS903	SAB-313		WBK-324	WBK-377	
DL650	06	SSS903	SAB-313		WBK-324	WBK-377	
DL650	07-08	SSS903			WBK-324	WBK-377	
DL650	09-10	SSS903					
DR650RE R/S	94-95	SSH901	SAB-311	SWS-306	WBK-149	WBK-241	
DR650S	92-93	SSH901	SAB-311	SWS-306	WBK-149	WBK-241	
DR650S	94-95	SSH901	SAB-311	SWS-306	WBK-149	WBK-241	
DR650SE	94-95	SSH901	SAB-311	SWS-306	WBK-149	WBK-241	
DR650SE	96-98	SSS904	SAO-310	SWS-307	WBK-150		
DR650SE	99-00	SSS904	SAO-310	SWS-307	WBK-150		
DR650SE	01-04	SSS904	SAO-310	SWS-307			
DR650SE	09	SSS904					
GR650X D	83	SSH901				WBK-241	
GR650 D/E	83-84	SSH901					
GS650 X/Z	81-82	SSH901	SAB-307	SWS-301	WBK-075	WBK-349	
GS650E X/Z	81-82	SSH901	SAB-307	SWS-301	WBK-075	WBK-241	
GS650M D	83	SSH901			WBK-075		
GS650GL	81-83	SSH901			WBK-075	WBK-119	
GS650G X-D	81-83	SSH901			WBK-075	WBK-119	
GSX650F	08-09	SSH901			WBK-328	WBK-226	
GSX650F	10	SSH901					
GSF650S BANDIT	05-06	SSH901			WBK-151	WBK-226	
GSF650S BANDIT	07-08	SSH901			WBK-328	WBK-226	
GSF650S BANDIT	09-10	SSH901					
LS650P	96-02	SSH901			WBK-075	WBK-241	
LS650P	03	SSH901			WBK-075	WBK-241	
LS650	09	SSH901					
SFV650	09-10	SSH901					
SV650	99-02	SSH901	SAB-308	SWS-309	WBK-151	WBK-229	
SV650	03	SSS903	SAB-313		WBK-382	WBK-226	
SV650	04-06	SSS903	SAB-313		WBK-382	WBK-226	
SV650S	03	SSS903	SAB-313		WBK-382	WBK-226	
SV650S	04-06	SSS903	SAB-313		WBK-382	WBK-226	
SV650	08	SSS903			WBK-382	WBK-226	
SV650	09-10	SSS903					
XF650	97-99	SSS904	SAO-310		WBK-150		
GS700E/ES	85				WBK-075	WBK-241	
GS750	77	SSS250	SAB-307		WBK-075	WBK-138	
GS750	78-79	SSS250	SAB-307	SWS-301	WBK-075	WBK-138	
GS750D	78	SSS250	SAB-307	SWS-301	WBK-075	WBK-138	
GS750D	79	SSS250	SAB-307		WBK-075	WBK-138	
GS750E	78-79	SSS250	SAB-307	SWS-301	WBK-075	WBK-138	
GS750L	79	SSS250	SAB-307	SWS-301	WBK-075	WBK-138	
GS750L	80-81	SSH901	SAB-307	SWS-301	WBK-075	WBK-138	
GS750S	83	SSH901	SAB-308	SWS-302	WBK-075	WBK-138	
GS750T	82-83	SSH901	SAB-307	SWS-301	WBK-075	WBK-138	
GSX750	80-81	SSH901	SAB-307		WBK-075	WBK-138	
GSX750	98-00	SSH901	SAB-308				
GSX750E	80-82	SSH901	SAB-307	SWS-301	WBK-075	WBK-138	
GSX750ES	83-84	SSH901	SAB-308		WBK-075	WBK-241	
GSX750ES	85-86	SSH901					
GSX750EF	84-85	SSH901	SAB-308				

MODEL		STEERING HEAD	SWING ARM	SWING ARM with COLLAR	FRONT WHEEL	REAR WHEEL	CRANKSHAFT
GSX750L	80-81	SSH901	SAB-307	SWS-301	WBK-075	WBK-138	
GSX750F	89-01	SSH901	SAB-307	SWS-303	WBK-075	WBK-242	
GSX750F	02-03	SSH901	SAB-307	SWS-303	WBK-075	WBK-242	
GSX750F	04-05	SSH901	SAB-307	SWS-303	WBK-324	WBK-242	
GSX750F	06	SSH901			WBK-324	WBK-242	
GSX-R750	86	SSH901	SAB-309		WBK-075	WBK-236	
GSX-R750	87	SSH901	SAB-308		WBK-075	WBK-236	
GSX-R750	88-92	SSH901	SAB-308	SWS-304	WBK-152	WBK-232	
GSX-R750	93-95				WBK-152	WBK-226	
GSX-R750	96-99	SSS903	SAB-312		WBK-214	WBK-235	
GSX-R750 K2	00-02	SSS903	SAB-312		WBK-214	WBK-234	
GSX-R750 K3	03	SSS903	SAB-312		WBK-214	WBK-234	
GSX-R750 K4-K8	04-08	SSS903R			WBK-214	WBK-345	
GSX-R750	09-10	SSS903R					
GSX-R750W	93	SSH901	SAB-308	SWS-304	WBK-152		
GSX-R750W	94-95	SSH901	SAB-312		WBK-152		
VS750GLP G-M	86-91	SSH901	SAB-311		WBK-075	WBK-239	
VS750GLF	86	SSH901	SAB-311		WBK-075	WBK-239	
VS750GLF	87-89	SSH901					
GT750 K-B	73-77	SSS250			WBK-075	WBK-133	
VL800 K1/K3	01-03	SSH901			WBK-151	WBK-119	
VL800K4-K6	04-06	SSH901			WBK-151	WBK-119	
VL800K7-K8	07-08	SSH901			WBK-151	WBK-119	
VL800	09-10	SSH901					
VX800	90-94	SSH901	SAB-308		WBK-075	WBK-119	
VX800	95-96	SSH901	SAB-308				
VS800GL	92-03	SSH901	SAB-311	SWS-306	WBK-075	WBK-239	
VZ800	97-00	SSH901	SAB-313	SWS-305	WBK-151	WBK-229	
VZ800	01-02	SSH901	SAB-313	SWS-305	WBK-151	WBK-229	
VZ800	03	SSH901	SAB-313	SWS-305	WBK-151	WBK-229	
VZ800	05-08	SSH901			WBK-151	WBK-119	
VZ800	09-10	SSH901			WBK-151	WBK-119	
GS850G	79-83	SSH901			WBK-075	WBK-119	
GS850G	84-86	SSH901					
GS850GL	80-83	SSH901			WBK-075	WBK-119	
RF900R R-V	94-97	SSH901			WBK-152	WBK-233	
DL1000	02-03	SSS903R	SAB-313		WBK-328	WBK-377	
DL1000	04	SSS903R	SAB-313		WBK-328	WBK-377	
DL1000	05-06	SSS903R	SAB-313		WBK-328	WBK-377	
DL1000 V-STORM	07-09	SSS903R			WBK-328	WBK-377	
DL1000 V-STORM	10	SSS903R					
GS1000	78-80	SSH901	SAB-308	SWS-302	WBK-075	WBK-138	
GS1000E	78-80	SSH901	SAB-308	SWS-302	WBK-075	WBK-138	
GS1000G	80-81	SSH901			WBK-075	WBK-119	
GS1000GL	80-81	SSH901			WBK-075	WBK-119	
GS1000H	78-80	SSH901	SAB-308	SWS-302	WBK-075	WBK-138	
GS1000S	79-82	SSH901	SAB-308	SWS-302	WBK-075	WBK-138	
GS1000L N	79	SSH901	SAB-308	SWS-302	WBK-075	WBK-138	
GSX-R1000 K1-K2	01-02	SSS903	SAB-312		WBK-214	WBK-234	
GSX-R1000 K3-K4	03-04	SSS903	SAB-312		WBK-214	WBK-345	
GSX-R1000 K5-K6	05-06	SSS903R	SAB-310		WBK-214	WBK-345	
GSX-R1000	07-08	SSS903R			WBK-214	WBK-345	
GSX-R1000	09-10	SSS903R					
SV1000	03-05	SSS903			WBK-214	WBK-345	
TL1000S	97-01	SSS903	SAB-312		WBK-214	WBK-235	
TL1000R	98-03	SSS903R			WBK-214	WBK-235	
GS1100GK	82-84	SSH901			WBK-075	WBK-119	
GS1100G	82-83	SSH901			WBK-075	WBK-119	
GS1100GL	82-83	SSH901			WBK-075	WBK-119	
GS1100S	83	SSH901	SAB-308	SWS-302	WBK-075	WBK-138	
GS1100E	80-83	SSH901	SAB-308	SWS-302	WBK-075	WBK-138	
GS1100L	80	SSH901	SAB-308	SWS-302	WBK-075	WBK-138	
GSX1100	80-81	SSH901	SAB-308		WBK-075	WBK-138	
GSX1100	82-83	SSH901	SAB-308	SWS-302	WBK-075	WBK-138	
GSX1100E	80-81	SSH901	SAB-308		WBK-075	WBK-138	
GSX1100E	82-83	SSH901	SAB-308	SWS-302	WBK-075	WBK-138	
GSX1100E	84-86	SSH901	SAB-308		WBK-075	WBK-138	
GSX1100ES E-G	84-86	SSH901	SAB-308		WBK-075	WBK-138	
GSX1100EF E-G	84-86	SSH901	SAB-308		WBK-075	WBK-138	
GSX1100F	88-93	SSH901	SAB-308	SWS-302		WBK-246	
GSX1100S	82-83	SSH901	SAB-308				

MODEL		STEERING HEAD	SWING ARM	SWING ARM with COLLAR	FRONT WHEEL	REAR WHEEL	CRANKSHAFT
GSX1100G	91-94	SSH901	SAB-308		WBK-151	WBK-152	
GSX1100L	80	SSH901	SAB-308	SWS-302	WBK-075	WBK-138	
GSX-R1100	86	SSH901	SAB-308	SWS-302	WBK-075	WBK-237	
GSX-R1100	87	SSH901	SAB-308	SWS-302		WBK-237	
GSX-R1100	88	SSH901	SAB-308	SWS-302	WBK-119	WBK-232	
GSX-R1100	89-90	SSH901	SAB-308	SWS-302	WBK-152	WBK-232	
GSX-R1100	91-92	SSH901	SAB-308	SWS-304	WBK-152	WBK-232	
GSX-R1100W	93-94	SSH901	SAB-308	SWS-304	WBK-152	WBK-233	
GSX-R1100W	95-98	SSH901	SAB-312		WBK-152	WBK-233	
GS1150ES 3/E/F	83-85	SSH901				WBK-137	
GS1150E F-G	85-86	SSH901				WBK-137	
GSF1200S BANDIT	96-02	SSH901	SAB-313		WBK-152	WBK-233	
GSF1200S BANDIT	03-05	SSH901	SAB-313		WBK-152	WBK-233	
GSF1200S BANDIT	06	SSH901					
GSX1200 X	99	SSH901	SAB-308	SWS-309	WBK-152	WBK-233	
GV1200GL F/G	85-86	SSH901					
GSF1250	07-09	SSH901			WBK-214	WBK-345	
GSF1250/A	10	SSH901					
GSF1250S/SA	10	SSH901					
GSX1300R	99-01	SSS903R	SAB-312		WBK-214	WBK-235	
GSX1300R	02	SSS903R	SAB-312		WBK-214	WBK-235	
GSX1300R	03-05	SSS903R	SAB-312		WBK-214	WBK-235	
GSX1300R	06	SSS903R	SAB-312		WBK-214	WBK-235	
GSX1300R HAYABUSA	07-09	SSS903R			WBK-214	WBK-345	
GSX1300R HAYABUSA	10	SSS903R					
GSX1300BK B-KING	08-09	SSS903R			WBK-214	WBK-345	
GSX1300BK B-KING	10	SSS903R					
GSX1400	06	SSH901	SAB-312		WBK-214	WBK-234	
GV1400G	86-87	SSH901					
GV1400GD	86-87	SSH901					
GV1400GTG	86	SSH901					
VS1400GLP	87-03	SSH901	SAB-307	SWS-303	WBK-075	WBK-119	
VS1400GLF	87-00	SSH901	SAB-307	SWS-303			
VS1400	09	SSH901					
VL1500	98-08	SSH901			WBK-151	WBK-228	
VL1500	09	SSH901					
VZ1500	09	SSH901					
VLR1800	09-10	SSH901					
VZR1800	06	SSH901			WBK-214	WBK-396	
VZR1800	07	SSH901					
			YAMAHA				
YSR50T-/E	87-93	SSY080					
TY50M	80	SSY080					
RX50K/L	83	SSY080					
RD50M	82	SSY080					
RD50M	80	SSY080					
DT50MX	82-86	SSY080					
DT50M	80	SSY080					
TZR50	03-08	SSY125					
DT80MX	81-82	SSY080					
DT80LC<53V>	85	SSY085					
DT80LCII	90	SSY085					
RD80MX	81-82	SSY080					
RD80LCI	82	SSY080					
YZ80	80-81	SSY080			WBK-297	WBK-361	CBK-021
YZ80	82-83	SSY080			WBK-297		CBK-021
YZ80	84-85	SSY088			WBK-297	WBK-332	CBK-021
YZ80	86-92	SSY088			WBK-298	WBK-332	CBK-021
YZ80	93-98				WBK-305	WBK-334	CBK-022
YZ80	99-01				WBK-305	WBK-334	CBK-022
YZ85	02				WBK-305	WBK-334	CBK-023
YZ85	03-05				WBK-305	WBK-334	CBK-023
YZ85	06				WBK-305	WBK-334	
TTR90	00-03	SSY080					
DT125 A-H	74-81	SSY080					

MODEL		STEERING HEAD	SWING ARM	SWING ARM with COLLAR	FRONT WHEEL	REAR WHEEL	CRANKSHAFT
DT125LC	82	SSY080					
DT125R	91-00	SSY085					
DT125X	05	SSH901					
MX125	74-76	SSY080					
NXC 125 CYGNUS X	04-08	SSY080					
RD125LC	82	SSY125					
SR125	97	SSY080					
TZ125G	80	SSY125					
TDR125	96	SSY085					
TDR125	97-99	SSY085	SAO-209				
TZR125	95-97	SSH901	SAO-209				
TW125	99-03	SSY080					
WR125R	09	SSK906RRR					
WR125X	09	SSK906RRR					
XT125 J	82	SSY080					
XV125S	99	SSY125					
XV125	97-00	SSY125					
XVS125	00-02	SSH901					
YP125R X-MAX	06-09	SSY913					
YP125E MAJESTY	03-09	SSY912					
YZ125	88-91	SSY901			WBK-272	WBK-341	
YZ125	92-95	SSY901			WBK-315	WBK-341	
YZ125	96-97	SSY903T			WBK-318	WBK-341	
YZ125	98	SSY903T			WBK-319	WBK-341	
YZ125	99-05	SSY903T			WBK-319	WBK-331	
YZ125	06-09	SSY903T			WBK-319	WBK-381	
YZ125R	10	SSY903T					
DT175 A-C	74-76	SSY080					
DT175 F-H	79-81	SSY080					
DT200R<37F>		SSY085					
DT200R<38F>		SSY085					
RD200 A-C	74-76	SSY125					
XT200	82-83	SSY080					
YFM200	85				WBK-045		
YFM200DX	86-89				WBK-045		
YTM200 EX/EL	83-84	SSY080					
YTM200 K/L	83-84	SSY080					
YTM200ERN	85	SSY125					
TW200J	97	SSY080					
TT225S	86-87	SSY085					
TTR225 N/P	01-02	SSY085					
XT225	92-98	SSY085					
XT225<1KH>		SSY085					
XT225 N	01	SSY085					
XT225	06-07	SSY085					
YFM225	86				WBK-045		
YTM225DR N-S	85-86	SSY125					
YTM225DX L/N	84-85	SSY125					
YTM225DX K	83	SSY080					
DT250 B-F	75-79	SSY080					
RD250LC	80-82	SSY125		SNB-201			
RD250 A/B	74-75	SSY125		SNB-201			
MX250	73-75	SSY080					
SR250 G-J	80-82	SSY125					
SRX250	87	SSY125					
TDR250	88-90	SSY085					
TZR250	88-90	SSY125					
TZ250 F-J	79-82	SSH901					
XT250	80-90	SSY080					
WR250Z	91	SSY901			WBK-272	WBK-339	
WR250Z	92-97	SSY901			WBK-299	WBK-339	
WR250F	02	SSY903T			WBK-320	WBK-331	
WR250F	03-05	SSY903T			WBK-320	WBK-331	
WR250F	06-09	SSY903T			WBK-320	WBK-381	
WR250F	10	SSY903T					
WR250FP	02	SSY903T					
XV250 U/W	88-89	SSY125					
XV250 G-K	95-98	SSY125					
YFB250	92-94				WBK-046	WBK-161R	
YFB250	95				WBK-047	WBK-161R	
YFM250	89-91				WBK-047		
YFM250	92-94				WBK-046		

MODEL		STEERING HEAD	SWING ARM	SWING ARM with COLLAR	FRONT WHEEL	REAR WHEEL	CRANKSHAFT
YP250	97	SSY080					
YP250D	98	SSY080					
YP250A/D	99	SSY080					
YP250R X-MAX	05-09	SSY913					
YZ250	83-87	SSH901			WBK-272	WBK-344	CBK-027
YZ250	88-91	SSH901			WBK-272	WBK-341	CBK-028
YZ250	92-95	SSY901			WBK-299	WBK-341	CBK-028
YZ250	96-97	SSY903T			WBK-318	WBK-341	CBK-028
YZ250	98	SSY903T			WBK-319	WBK-341	CBK-029
YZ250	99	SSY903T			WBK-319	WBK-331	CBK-029
YZ250	00	SSY903T			WBK-319	WBK-331	CBK-030
YZ250	01-05	SSY903T			WBK-319	WBK-331	CBK-031
YZ250	06	SSY903T			WBK-319	WBK-381	
YZ250	07-09	SSY903T					
YZ250F	01-05	SSY903T			WBK-319	WBK-331	
YZ250F	06-08	SSY903T			WBK-319	WBK-381	
YZ250F	09	SSY903T			WBK-319	WBK-391	
YZ250F	10	SSY903T					
RD350 -/A/B	73-75	SSY125		SNB-201	WBK-050		
RD350LC	80-82	SSY125		SNB-201			
RD350LC YPVS	83-84	SSY125		SNB-201			
RD350LC	85	SSY125					
RZ350	84	SSY125			WBK-057	WBK-065	
RZ350	85	SSY125					
XT350,H	85-90	SSH901					
XS360 C/D	76-77	SSY125					
YFM350ER	89-95				WBK-047		
YFM350X	87-95				WBK-048		
DT400	75-78	SSY080					
FZR400	88-90			SWS-202	WBK-056	WBK-129	
FZ400R	92-93	SSY500					
FZR400R	88-90	SSH901					
RD400	76-78	SSY125			WBK-050	WBK-066	
RD400	79	SSY125			WBK-056	WBK-067	
WR400F	98	SSY903T			WBK-320	WBK-341	
WR400F	99-00	SSY903T			WBK-320	WBK-331	
WR400F	01-02	SSY903T					
XJ400	80-85	SSY125					
XS400	77-81	SSY125		SNB-201			
XS400R	82-83	SSY125					
XS400S G/H	80-81	SSY125		SNB-201			
XS400S J	82	SSY125		SNB-201			
XS400SE	81-82	SSY125					
WR426F	01-02	SSY903T			WBK-320	WBK-331	
YZ426F	00-02	SSY903T			WBK-320		
WF450F	03	SSY903T			WBK-320	WBK-331	
WR450F	04-05	SSY903T			WBK-320	WBK-389	
WR450F	06-09	SSY903T			WBK-320	WBK-381	
WR450F	10	SSY903T					
YZ450F	03-05	SSY903T			WBK-319	WBK-331	
YZ450F	06-08	SSY903T			WBK-319	WBK-381	
YZ450F	09	SSY903T			WBK-319	WBK-391	
YZ450F	10	SSY903T					
SR500	78-79	SSY080	SAO-201		WBK-050	WBK-071	
SR500	80-84	SSY080	SAO-201		WBK-050	WBK-069	
SR500	85-87	SSY080	SAO-201				
SR500	88-93	SSY080	SAO-201		WBK-314	WBK-069	
TT500	76-81				WBK-060	WBK-070R	
TX500/A	73-74	SSY500					
XP500 T-MAX	03-07	SSH901					
XP500 T-MAX	08-10	SSY911					
XP500 T-MAX ABS	08-10	SSY911					
XS500 B-E	75-78	SSY500					
XT500	76-81	SSY080	SAO-201		WBK-059	WBK-069	
XT500	88	SSY080			WBK-059	WBK-069	
XV500	83	SSY125	SAB-101				
XV535	87-01	SSY125	SAB-101	SWS-201	WBK-050	WBK-075	
XV535SE	88	SSY125	SAB-101	SWS-201	WBK-050	WBK-075	
XV535S	96-97	SSY125	SAB-101	SWS-201	WBK-050	WBK-075	

MODEL		STEERING HEAD	SWING ARM	SWING ARM with COLLAR	FRONT WHEEL	REAR WHEEL	CRANKSHAFT
XJ550 MAXIM	81-83	SSY125			WBK-056	WBK-268	
XJ550R SECA	81-82	SSY125		SNB-201	WBK-056	WBK-268	
XJ550R SECA	83	SSY125		SNB-201			
XS550R K/J	82-83	SSY500					
XT550	82-83	SSH901					
XZ550R	82-83	SSY500	SAB-101		WBK-056	WBK-064	
FZ600 S-U	86-88	SSY500	SAB-101	SWS-202	WBK-056	WBK-271	
FZ600 FAZEER	04-05	SSH901					
FZ600N	04-05	SSH901					
FZR600R	89	SSH901	SAB-101	SWS-202	WBK-056	WBK-264	
FZR600R	90-91	SSH901	SAB-101	SWS-202	WBK-056	WBK-264	
FZR600R	92-93	SSH901	SAB-101	SWS-202	WBK-056	WBK-264	
FZR600R	94-95	SSH901	SAB-101	SWS-202	WBK-124	WBK-153	
FZR600R (U.S.A.)	94-98				WBK-056	WBK-264	
FJ600	84-85	SSY125		SWS-202	WBK-056	WBK-271	
FZS600	98-99	SSH901	SAB-101	SWS-204	WBK-308	WBK-153	
FZS600	00-01	SSH901	SAB-101	SWS-204	WBK-308	WBK-373	
FZS600	02	SSH901	SAB-101		WBK-308	WBK-373	
FZS600	03	SSH901	SAB-101		WBK-308	WBK-373	
FZS600	04-05	SSH901					
FZS600	06	SSH901				WBK-383	
FZS600P	02	SSH901	SAB-101				
FZS600R	03	SSH901					
FZS600S	01	SSH901	SAB-101	SWS-204			
FZS600SN	01	SSH901	SAB-101	SWS-204			
FZ6-N	04-06	SSH901					
FZ6-NS	05-06	SSH901					
FZ6-S FAZER	04-06	SSH901					
FZ6-SHG	07	SSH901					
FZ6 FAZER	04-08	SSH901			WBK-303	WBK-383	
FZ6 FAZER S2	08	SSH901			WBK-303	WBK-383	
FZ6 FAZER S2 ABS	08	SSH901			WBK-303	WBK-383	
TT600R	00-01	SSY901					
SRX600 S	86	SSY500					
XJ600	84	SSY125	SAB-101	SWS-202	WBK-056	WBK-271	
XJ600	85-88	SSY125					
XJ600S	92-95	SSH901	SAB-101	SWS-202	WBK-127	WBK-264	
XJ600S	96-98	SSH901	SAB-101	SWS-202	WBK-127	WBK-264	
XJ600S	99	SSH901	SAB-101	SWS-202	WBK-127	WBK-264	
XJ600N	00-02	SSH901	SAB-101	SWS-202	WBK-127	WBK-264	
XJ6-F DIVERSION	10	SSH901					
XJ6-N	09-10	SSH901					
XJ6-S DIVERSION	09-10	SSH901					
XT600	84-89	SSH901	SAO-208		WBK-291	WBK-355	
XT600E	90-94	SSH901	SAO-209		WBK-291	WBK-354	
XT600E	95-96	SSH901R			WBK-291	WBK-354	
XT600E	97-02	SSH901			WBK-291	WBK-354	
XT600H	89	SSH901					
XT600Z	83	SSH901					
XT600Z	84-90	SSH901	SAO-208		WBK-291	WBK-355	
YX600	86-90	SSY125					
YZF-R6	99-02	SSS903R			WBK-303	WBK-394	
YZF-R6	03-05	SSS903R			WBK-303	WBK-383	
YZF-R6	07-09	SSY911			WBK-392	WBK-383	
YZF-R6	10	SSY911					
YZF-R6 LTD	06	SSY911					
YZF-R6S	08	SSS903R			WBK-303	WBK-383	
YZF-R6P	02	SSS903R					
YZF600R	95	SSH901	SAB-101	SWS-204	WBK-124	WBK-153	
YZF600R	96-98	SSH901	SAB-101	SWS-204	WBK-124	WBK-153	
YZF600R	99-00	SSH901	SAB-101	SWS-204	WBK-124	WBK-153	
YZF600R	01-04	SSH901	SAB-101	SWS-204	WBK-124	WBK-373	
YZF600R	05-06	SSH901			WBK-124	WBK-373	
YZF600R	07	SSH901					
TX650 A	74	SSY500			WBK-050	WBK-061	
XJ650 MAXIM	80-83	SSY500			WBK-056	WBK-064	
XJ650L	81	SSY500			WBK-056	WBK-064	
XJ650L J/K	82-83	SSY500					
XJ650R SECA	82	SSY500			WBK-056	WBK-064	
XS1/XS1B	70-71				WBK-049	WBK-061	
XS650	75				WBK-050	WBK-061	
XS650	76-77	SSY500		SNB-201	WBK-050	WBK-061	
XS650	78	SSY500		SNB-201	WBK-050	WBK-061	
XS650	79	SSY500		SNB-201	WBK-050	WBK-061	

MODEL		STEERING HEAD	SWING ARM	SWING ARM with COLLAR	FRONT WHEEL	REAR WHEEL	CRANKSHAFT
XS650 G/H	80-81	SSY500		SNB-201	WBK-050	WBK-061	
XS650 J/K	82-83	SSY500		SNB-201			
XS650S	78-81	SSY500			WBK-050	WBK-061	
XS650S HEGITAGE SPE	82-83	SSY500			WBK-050	WBK-061	
XVS650A	98-05	SSH901	SAO-210		WBK-050	WBK-075	
XVS650A	06	SSH901			WBK-050	WBK-075	
XVS650A	07	SSH901					
XVS650	97-03	SSH901	SAO-210		WBK-050	WBK-075	
XVS650	06	SSH901			WBK-050	WBK-075	
XVS650	07	SSH901					
XVS650AT	06	SSH901			WBK-050	WBK-075	
XVS65 V-STAR C.	04	SSH901	SAO-210				
XVS65AT V-STAR SILV	04	SSH901	SAO-210				
XVS65A V-STAR CLASS	04	SSH901	SAO-210				
MT-03	06-09	SSH901					
XT660H,N	92-93	SSH901					
XT660Z TENERE	08-09	SSH901					
XT660R	04-10	SSH901					
XT660X	04-10	SSH901					
XV700 L/N	84-85	SSH901					
XV700S S	86	SSH901					
XV700C S/T	86-87	SSH901					
XJ700 N/S	85-86	SSH901					
XJ700X N/S	85-86	SSH901					
FZ750 N/S	85-86	SSH901		SWS-203	WBK-056	WBK-264	
FZ750	89-94	SSH901					
FZR750R	87/88	SSH901		SWS-203	WBK-056	WBK-253	
FZX750 S/T	86-87	SSH901					
TX750	73	SSY500					
XJ750 MAXIM	82-83	SSY500			WBK-056	WBK-064	
XJ750R SECA	81-83	SSY500			WBK-056	WBK-064	
XJ750M MIDMIGHT MA	83	SSY500			WBK-056	WBK-064	
XS1	70-72	SSY500					
XS750	78-79	SSH901			WBK-050	WBK-062	
XS750SE	80	SSH901			WBK-050	WBK-062	
XS750S	78-79	SSH901			WBK-050	WBK-062	
XTZ750	89	SSH901	SAO-209				
XTZ750	90	SSH901	SAO-209				
XTZ750	91-93	SSH901					
XV750	81-83	SSY500	SAB-101	SWS-201	WBK-056	WBK-064	
XV750	88-96	SSH901	SAO-210		WBK-055	WBK-064	
XV750MK VIRAGO	81-82	SSY500	SAB-101	SWS-201			
XV750MK VIRAGO	83	SSY500	SAB-101	SWS-201	WBK-056		
XV750SE	81	SSY500					
XV750SE	82	SSY500	SAB-101	SWS-201	WBK-056	WBK-064	
XV750SE	95-96	SSH901					
YZF750R	94-97	SSH901	SAB-201	SWS-206	WBK-125	WBK-263	
FZ8-N	11	SSY-911					
FZ8-S	11	SSY-911					
TDM850	91-99	SSH901	SAB-101	SWS-202	WBK-050	WBK-264	
TRX850	96-99	SSH901					
XS850	80-81	SSH901			WBK-050		
XS850S	80-81	SSH901			WBK-050		
XS850L	80-81	SSH901			WBK-050		
TDM900	03-05	SSS903R				WBK-387	
TDM900	08-10	SSS903R					
XJ900	83	SSH901	SAO-210		WBK-056	WBK-154	
XJ900	84-85	SSH901	SAO-210		WBK-056	WBK-154	
XJ900,F	86-88	SSH901					
XJ900S	95-02	SSH901	SAO-210		WBK-127	WBK-340	
XJ900SP	02	SSH901	SAO-210				
XV920RH/RJ	81-82	SSY500	SAB-101	SWS-201	WBK-056		
XV920M K	83	SSY500	SAB-101	SWS-201	WBK-056	WBK-064	
XV920 J/K	82-83	SSY500	SAB-101	SWS-201	WBK-056	WBK-064	
XVS950	09-10	SSH901					
FZR1000	87-88	SSH901	SAB-308	SWS-203	WBK-056	WBK-253	
FZR1000	89-90	SSH901	SAB-204	SWS-205	WBK-127	WBK-254	

MODEL		STEERING HEAD	SWING ARM	SWING ARM with COLLAR	FRONT WHEEL	REAR WHEEL	CRANKSHAFT
FZR1000	91-93	SSH901	SAB-204	SWS-205	WBK-127	WBK-252	
FZR1000	94-95	SSH901			WBK-125	WBK-252	
FZS1000	01	SSH901	SAB-201	SWS-206	WBK-308	WBK-373	
FZS1000	02-05	SSH901	SAB-201	SWS-206	WBK-303	WBK-384	
FZS1000S	03	SSH901	SAB-201	SWS-206			
FZ-1S FZ1	04	SSS903					
FZ-1	06-07	SSY911			WBK-303		
FZ-1	08-09	SSY911					
FZ-1 ABS	07-08	SSY911			WBK-303		
FZ-1 FAZER	06-09	SSY911			WBK-303		
FZ-1 FAZER	10	SSY911					
GTS1000	93-94					WBK-252	
XV1000	81-82	SSY500					
XV1000	83		SAB-101				
XV1000	84-85	SSH901			WBK-055	WBK-064	
YZF1000R	96-01	SSH901	SAB-201	SWS-206			
YZF1000R	02	SSH901					
YZF-R1	98-99	SSS903R	SAB-203		WBK-303	WBK-394	
YZF-R1	00-01	SSS903R	SAB-203		WBK-303	WBK-384	
YZF-R1	02-03	SSS903R	SAB-203		WBK-303	WBK-383	
YZF-R1	04-06	SSS903R	SAB-202		WBK-303	WBK-383	
YZF-R1	07-09	SSY911			WBK-392	WBK-383	
BT1100	02-05	SSH901					
BT1100	06	SSH901			WBK-303	WBK-340	
FJ1100	84-85	SSH901	SAB-308	SWS-203	WBK-056	WBK-254	
XJ1100	82	SSH901			WBK-128		
XS1100	78-79				WBK-050		
XS1100	80-81	SSH901	SAO-210		WBK-050		
XS1100S	79-81	SSH901	SAO-210		WBK-050		
XS1100L	80-81				WBK-050		
XV1100	97	SSH901	SAO-210				
XV1100	86-88	SSH901	SAO-210		WBK-055	WBK-064	
XV1100	89	SSH901	SAO-210		WBK-055	WBK-064	
XV1100	90-97	SSH901	SAO-210		WBK-055	WBK-064	
XV1100	98-99	SSH901	SAO-210				
XVS1100	98	SSH901	SAB-101	SWS-201			
XVS1100	99-01	SSH901	SAB-101	SWS-201	WBK-316	WBK-154	
XVS1100	06	SSH901			WBK-316	WBK-154	
XVS1100	07	SSH901					
XVS1100A	01-05	SSH901	SAB-101	SWS-201	WBK-316	WBK-154	
XVS1100A	06				WBK-316	WBK-154	
XVS1100AT	06	SSH901					
XVS1100AT	07	SSH901					
XJR1200	95-98	SSH901			WBK-127	WBK-252	
FJ1200	86-87	SSH901	SAB-308	SWS-203	WBK-056	WBK-256	
FJ1200	88-89	SSH901	SAB-308	SWS-203	WBK-056	WBK-257	
FJ1200	90	SSH901	SAB-308	SWS-203			
FJ1200	91-92	SSH901	SAB-308	SWS-203	WBK-056	WBK-252	
FJ1200	93	SSH901	SAB-308	SWS-203	WBK-056	WBK-252	
FJ1200A D/E	92-93	SSH901					
XT1200X SUPERTENERE	10	SSY903T					
XVZ12TD	83	SSH901	SAO-212				
XVZ12T	83	SSH901	SAO-212				
XVZ12D	84-85	SSH901	SAO-212				
VMX12 V-MAX	85-97	SSH901	SAO-210		WBK-128	WBK-160*	
VMX12 V-MAX	98	SSH901	SAO-210		WBK-128	WBK-160*	
VMX12 V-MAX	99-04	SSH901	SAO-210		WBK-128		
VMX12 V-MAX	05-06	SSH901			WBK-128		
VMX1W1 V-MAX	07	SSH901					
FJR1300R	03	SSS903R					
FJR1300	08	SSS903R					
FJR1300A ABS	04-05	SSS903R			WBK-303		
FJR1300A ABS	06-10	SSS903R					
FJR1300S	04	SSS903R					
XJR1300SP	99-01	SSH901		SWS-206			
XJR1300	99	SSH901			WBK-125	WBK-252	
XJR1300	00	SSH901			WBK-304	WBK-252	
XJR1300	01	SSH901	SAB-201	SWS-206	WBK-304	WBK-252	
XJR1300	02-03	SSH901	SAB-201	SWS-206	WBK-304	WBK-387	
XJR1300	04	SSH901	SAB-201	SWS-206			

MODEL		STEERING HEAD	SWING ARM	SWING ARM with COLLAR	FRONT WHEEL	REAR WHEEL	CRANKSHAFT
XJR1300	05	SSH901	SAB-201	SWS-206	WBK-303	WBK-384	
XJR1300	06	SSH901			WBK-303	WBK-384	
XJR1300N	01	SSH901					
XJR1300P	02	SSH901					
XJR1300R	03	SSH901					
XJR1300	08-10	SSH901					

XVZ13TFS	0	SSH901					
XVZ13 VENTURE	87-88	SSH901	SAO-212				
XVZ13D VENTURE ROYAL	86-93	SSH901	SAO-212				
XVZ13A ROYAL STAR	96-98	SSH901	SAO-211				
XVZ13A ROYAL STAR B	99-01	SSH901	SAO-211				
XVZ13AT ROYAL STAR	96-00	SSH901	SAO-211				
XVZ13CT	06	SSH901			WBK-303		
XVZ13CTM	06	SSH901			WBK-303		
XVZ13LT ROYAL SATR	97-01	SSH901	SAO-211				
XVZ13TF ROYAL STAR	99-04	SSH901	SAO-211				
XVZ13TF	05-06	SSH901			WBK-303		
XVZ13TF	07	SSH901					
XVZ13TFM ROYAL STAR	04	SSH901	SAO-211				
XVZ13TFM	05-06	SSH901			WBK-303		
XVZ13TFM	07	SSH901					
XVS13TFS ROYAL STAR	00	SSH901	SAO-211				
XVS13TFS ROYAL STAR	02-03	SSH901	SAO-211				
XVS1300A MID.N.STAR		SSH901					
XV1600A	99	SSH901	SAB-308				
XV1600A <5AJ8>	01	SSH901	SAB-308				
XV1600A	02	SSH901					
MT-01	09	SSH901					
XV1700	03	SSY905					
XV17AT ROYAL-STAR S	04	SSH901	SAB-308				
XV17AT	07	SSH901					
XV17A ROADSTAR	04	SSH901	SAB-308				
XV17AM ROADSTAR MII	04	SSH901	SAB-308				
XV17AM	07	SSH901					
V-MAX (1700)	09-10	SSK901Y					
	BMW						
ALL MODEL	59-69	SSW055					
ALL MODEL (EXCEPT F	70-	SSW901					
F650	93-99	SSW902					
	KTM						
ALL OFF-ROAD BIKE		SST901					
125-640 cc							

REMARKS:

SSY903T: SEPARATE DUST SEAL

WBK-160: CYLINDRICAL BEARING NOT INCLUDED.

WBK-385/386 NO LONGER AVAILABLE

**REAR WHEEL
DRIVEN FLANGE NEEDLE BEARING & BUSH SET**

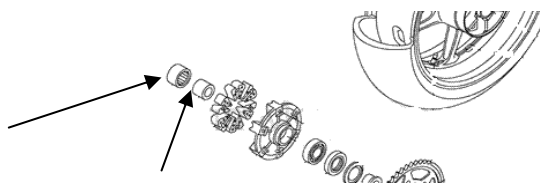

STOCK NO	DETAILS	APPLICATION
DNB-201	NEEDLE BEARING	1 YZF-R6 99-02
	BUSH	1 YZF-R7 99-00
		1 YZF-R1 98-09
		1 FZ6 FAZER 08
		XJR1300 04-06 FZS1000 FAZER 05-05
DNB-202	NEEDLE BEARING	1 YZF-R6 03-09
	BUSH	1 FZ6-N 04-05 FZ6-NS 05
		1 FZ6 FAZER 04-07
DNB-204	NEEDLE BEARING	1 XV1600 WILD STAR (ALL) 99-03
		1 XV16A (ALL) 07
	BUSH	1 XV1600A WILDSTAR(ALL) 03-04
	OIL SEAL	1 XV1700 ROAD STAR(ALL) 02-03
		1 XV1700 ROAD STAR (ALL) 04-09
DNB-205	NEEDLE BEARING	1 XVZ13 ROYAL STAR(ALL) 96-08
	BUSH	1
	OIL SEAL	1
DNB-206	NEEDLE BEARING	1 VMX1200 V-MAX 86-08
	BUSH	1 XVZ12TD 88
	OIL SEAL	1 XVZ13TD 89-90

SHOCK BEARING KITS FOR STREET MODELS

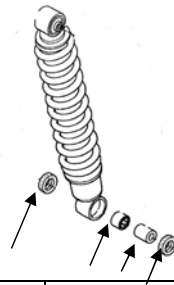

HONDA

SBK-101	98-05	NT650V
	98-01	VFR800FI
	02-05	VFR800A
	97-06	VTR1000F
	00-06	XL1000V
	04-06	CBF500
	04-06	CBF500A
	04-06	CBF600N
	04-06	CBF600S
	04-06	CBF600SA
	06-07	CBF1000
	06-07	CBF1000A
	SBK-102	00-01
02-06		CB900F
97-00		CBR1100XX
01-06		CBR1000XX
97-06		CBR600F
97-98		CBR600F3
99-04		CBR600F4
01-02		CBR600FR
01-02		CBR600FS
01-02		CBR600SE
2001		CBR900RE
98-03		CBR900RR
02-06		VFR800
2006		VFR800A
1999		XL1000V
04-06	XL1000VA	
01-06	XL125V	
03-06	XR125L	
SBK-103	91-96	CBR600F
	91-94	CBR600F2
	95-96	CBR600F3
	1996	CBR600SE
	92-97	CBR900RR

YAMAHA

SBK-201	98-99	FZS600
	00-03	FZS600
	96-02	YZF600R
	93-96	YZF750R
	96-00	YZF1000R
	99-02	XVS1100
	00-06	XSV1100A
	00-02	YZF-6R
	06-07	YZF-6R
	03-05	YZF-R6
SBK-202		

SUZUKI

SBK-301	91-93	GSF400M-P
	96-04	GSF600S-K4
	05-08	GSF650K5-K8
	96-06	GSF1200T-K6
	07-08	GSF1250
	06-08	GSR600K6-K8

SUZUKI

SBK-301	92-05	GSX-R600WN-K5
	06-09	GSX-R600K6-K9
	92-95	GSX-R750N-S
	96-03	GSX-R750T-K3
	04-08	GSX-R750K4-K8
	01-08	GSX-R1000K1-K8
	90-98	GSX-R1100L-W
	99-07	GSX-R1300R X-K7
	88-06	GSX600F J-K6
	89-06	GSX750F K-K6
	08-09	GSX650F K8-K9
	2008	GSX1300K8 B-KING
	98-00	TL1000R W-Y

KAWASAKI

SBK-401	91-93	ZX600D2-D4
	93-03	ZX600E1-E11
	04-05	ZX600E12H/E13H
	2006	ZX600E6F
SBK-402	00-01	ZX600J1P/J2P ZX-6R
	03-04	ZX600K1H/M1H ZX-6RR
	03-04	ZX600B1H/B2H ZX-6R
	2002	ZX636A1P ZX-6R
	00-01	ZX900E1P/E2P ZX-9R
	02-03	ZX900F1H/F2H ZX-9R
	02-03	ZX900F1P/F2P ZX-9R
	00-01	ZX1200A1H/A2H ZX-12R
	02-05	ZX1200B1H-B4H ZX-12R
	2006	ZX1200B6F ZX-12R
	03-05	ZR1000A1H-A3H Z1000
	2006	ZR1000A6F Z1000
	SBK-403	91-92
93-95		ZX750L1-L3 ZXR
91-92		ZX750K1/K2 ZXR
93-94		ZX750M1/M2 ZXR
95-97		ZX600F1-F3 ZX-6R
96-97		ZX750N1-N3 ZX-7RR
96-02		ZX750P1-P7 ZX-7R
94-97		ZX900B1-B4 ZX-9R
1999		ZR750F1 ZR-7
2001		ZR750F3 ZR-7
2003	ZR750F5 ZR-7	
01-03	ZR750H1-H3 ZR-7S	
SBK-404	98-99	ZX900C1/C2 ZX-9R
	98-99	ZX900G1/G2 ZX-9R
SBK-405	90-93	ZX1100C1-C4 ZZR
	95-97	ZX1100E1-E3 GPz
	93-99	ZX1100D1-D7 ZZR
SBK-406	07-08	ZX600P7F/P8F ZX-6R
	2005	ZX600N1H ZX-6RR
	04-05	ZX1000C1H/C2H ZX-10R
	06-07	ZX1000D6F/D7F ZX-10R
	06-07	ZX1400A6F/A7F ZZR
	06-07	ZX1400B6F/B7F ZZR
	2007	ZR1000B7F Z1000

VOLTAGE REGULATOR/RECTIFIER

Depending on the market, the different parts might be used in your market.



**TOUR
MAX**
IN PERFORMANCE EQUIPMENT

STOCK NO	MODEL APPLICATION	
HONDA		
RGU-101	CB250T I/T II	78
	CB400T I/T II	78
	CB400Tz	79
	CB400T HAWK	80-81
	CM400A AUTOMATIC	79-81
	CM400C CUSTOM	81
	CM400T	79-81
	CM400E	80-81
	CB400SC NIGHTHAWK	82-83
	CB450SC NIGHTHAWK	85-86
	CB450T HAWK	82
	CM450A AUTOMATIC	82-83
	CM450E AUTOMATIC	82-83
	CM450C CUSTOM	82
	FT500 ASCOT	82-83
	GB500	89
RGU-102	GL1100 (A-D) GOLDWING	80-83
	GL1100A (C/D) ASPENCADE	82-83
	GL1100I(A-D) INTERSTATE	80-83
	GL1100D (B-D)	81-83
	GL1200(E) GOLDWING	84
	GL1200D(E)	84
	GL1200A ASPENCADE	84-87
GL1200I INTERSTATE	84-87	
RGU-103	VF700F INTERCEPTOR	84-85
	VF700S SABRE	84-85
	VF750F(D/E/F) INTERCEPTOR	83-85
	VF750S(C/D) SABRE	82-83
	VF1000F(E) INTERCEPTOR	84
VF1100S SABRE	84-85	
RGU-104	CB900C	81-82
	CB900F (B/F2B/FC/F2C)	81-82
	CB750K	81-82
	CB750C	81-82
	CB750F(B/FC/F2C)	81-82
	CB750SC	82-83
RGU-105	CB900C	80
	CB750K	79-80
	CB750L	79
	CB750C	80
	CB750F(Z/A)	79-80
	CB900F(Z/A)	79-80
RGU-107	VT125C2	00
	VT125C2	99-00
	CB400FK/FII CB1	NC27
	CB400FL/FII CB1	NC23
	CBR400RRJ	NC23
	CBR400RRK	NC23
	CB400 SUPER FOUR	NC31
	CBR400RRL/RRN/RRR	NC29
	CB400FM/FMII CB-1	NC27
	VFR400R3N	NC30
	VFR400R3K/R3L	NC30
	CB500	96-99
	CB500S	98-99
	CB600F	98-01
	CB600F2	00-01
	CBR600F	93-00
	CBR600F2	91-94
	CBR600F3	95-98
	CBR600F4	99-00
	CBR600SE	96-98
	CBR900RR	93-99
	NT650V	98-00
	NV750C2	99
	VT750C	97-00
	VT750C2	97-00
	PC800 PACIFIC COAST	89-90
	PC800 PACIFIC COAST	94-98
	VTR1000F	97-00
	XL1000V	99-00
	RGU-110	VTR250
VF400RH/RJ<NC24>		

STOCK NO	MODEL APPLICATION	
RGU-112	CB350F/F1	72-74
	CB400F	75-77
	CB500K0-K2	71-73
	CB550F	75-77
	CB550K/K1	74-76
	CB550K/K1	77-78
	CB750F	75-78
	CB750K	69-78
RGU-113	CB750 NIGHTHAWK	91-98
	CB750F2	94-99
	CB750F2	01
	CB1000F	93-96
	CBR1000F	91-99
	ST1100A	93-95
ST1100	93-95	
RGU-114	CBR1100XX BLACKBIRD	99-00
RGU-115	VT600C SHADOW VLX	92-97
	VT600CD SHADOW VLX DELUXE	93-98
RGU-117	CBR900RR/CBR929	00-01
RGU-118	VFR750F	90-97
	CBR1100XX BLACKBIRD	97-98
RGU-119	TRX300	93-00
	TRX300FW	93-96
RGU-120	TRX300EX	93-00
RGU-121	VF750C MAGNA	94-00
	VF750CD MAGNA DELUXE	95-00
RGU-122	CBR600F	87-90
RGU-125	XRV750 P-Y	93-00
RGU-126	CBR600F	01-04
	CBR600F4	01-04
	CBR600FS/FR	01-02
RGU-127	VTR1000SP Y/1	00-01
RGU-128	CX500	
	CX500Z	79
	CX500A	80
	CX500CA	80
	CX500DA	80
RGU-129	VT1100C SHADOW	95-97
RGU-130	CB250 (TWO FIFTY)	
RGU-131	VFR800	98-99
RGU-132	VT1100C2	95-97
RGU-135	VT750C C/D/E	82-84
RGU-136	CB650	81-82
	CB650C	81
	CB650SC C	82
RGU-137	DIO 50	
RGU-139	GL1200 L LTD	85
	GL1200SEI	86
RGU-140	CB959RR	02
RGU-142	VFR800FI	00-01
RGU-143	VFR800	02-03
RGU-144	XL600V TANSALP	89-90
	XL600V TANSALP	91
RGU-146	XL650V	00-01
	TRX350FE/FM/TE/TM	00-03
	TR400FW	01-03
	TRX450ES/S	01
RGU-147	CBR1100XX	01-03
RGU-148	VFR800	04-09
	VFR800	04-09
RGU-150	FES125	98
	NES150	00
	NSS250	01
	CB600F	03-06
	CBF600N	04-06
VT750C2	01	
RGU-152	FX650	99-00
	SLR650	97-98

STOCK NO	MODEL APPLICATION	
RGU-154	CBR800RR	03-04
RGU-155	CB900F	02-03
RGU-158	NX650 DOMINATOR	95-00
RGU-160	CA125 CMX250C	95-99 96-99
RGU-161	XR650R	01-06
regulator rectifier		
RGU-169	XR650R	01-06
regulation only		
RGU-162	VTR1000SP	02-06
RGU-163	FJS600 FJS600A FJS-600D	02 03-05 03-05
RGU-164	CBR1000RR	04-05
RGU-165	CB1300 CB1300S	05-07 05-07
RGU-166	CB600F CB600FA CBF600N CBF600NA CBF600S CBF600SA	07-08 07-08 08 08 08 08
RGU-167	VFR800FI	00-01
RGU-168	CB900F HORNET	04-07
RGU-170	XR600R A USA XR600R AC USA XR650R A USA XR650R A/A USA XR650R AC USA	91-00 98-00 00-07 03-05 00-06
YAMAHA		
RGU-201	XV535SE XV535 VIRAGO XV535 VIRAGO XV535 VIRAGO XV535S VIRAGO XV700L/LC/N/NC VIRAGO XV700CS/CSC/CT/CTC VIRAGO XV700SS/SSC VIRAGO XV750U/UC/W/WC/A/AC/B/BC VIRAGO XV750D/DC/E/EC/F/FC/G/GC VIRAGO XV750H1/H1C VIRAGO XV1000L/LC/N/NC VIRAGO XV1100S/SC/T/TC/U/UC/W/WC VIRAGO XV1100A/AC/B/BC/D/DC/E/EC XV1100F/FC/G/GC/H/HC VIRAGO XV1000SH/SHC VIRAGO	88 87-88 90 93-96 94-96 84-85 86-87 86 88-91 92-95 96 84-85 86-89 90-93 94-96 96
RGU-202	XV250U/UC/W/WC/A/AC ROUTE 66 FZR400U/SUC/W/SWC/A/SAC FZR600W/SWC/AC FZR600R (A/AC/B/BC/D/DC) FZR600R (E/EC) TW200U/UC/W/WC/A/AC/B/BC TW200D/DC/E/EC/F/FC/G/GC TW200H/HC/J/JC TW200EK/EKC XT225D/DC/E/EC/F/FC/G/GC XT600E	88-90 88-90 89-90 90-92 93 88-91 92-95 96-97 98 92-95 90-94
RGU-204	FJ600L/LC/N/NC YX600S/SC/T/TC/U/UC XJ650G/H/J/K MAXIM XJ650LH MIDNIGHT MAXIM XJ650LJ/LK SECA TURBO XJ650RJ SECA XJ700N/NC/S/SC MAXIM XJ700XN/XNC/XS/XSC MASIM XJ750J/K MAXIM XJ750MK MIDNIGHT MAXIM XJ750RH/RK SECA XJ900RK SECA	84-85 86-88 80-83 81 82-83 82 85-86 85-86 82-83 83 81-83 83
RGU-206	YFB250FWJ-FWM YFB250UJ/UK YFM250M/MC YFM250XL/XLC YFM350FWJ/FWBJ YFM350FH/FHLC YFM350FWBK/FWBK/FWBL/FWBLC YFM350UH/UJ/UK/UL/ULC YFM350FXG/FXH/FXJ/FXK YFM350FXL/FXLC/FXM/FXMC YFM350XH/XJ/XK/XKC YFM350XL/XLC/XM/XMC	97-00 97-98 00 00 97 99 98-99 96-99 95-98 99-00 96-98 99-00

STOCK NO	MODEL APPLICATION	
RGU-206	YFM400FWH/FWJ/FWK/FWL/FWLC YFM400FVNH YFM400FVNM/FVNM/C YFM400NM/NMC YFM600FWAK	96-99 00 00 00 98
RGU-208	XT600E'95-96 TDR125	95-96 95-96
RGU-209	YZF-R1 TDM850 XT660Z SZR660R XVS850 DRAGSTAR YZF-R6 YZF600R THUNDER CAT FZR600R XP500 T-MAX YP250 MAJESTY YZF125P	98-01 98-01 94-96 95-97 97-99 99-00 96-02 94-97 01-03 00-01 08
RGU-210	XV650AK/AKC/AL/ALC V-STAR CLASSIC XV650AM/AMC V-STAR CLASSIC XV650L/LC/MC V-STAR XVS1100AM/AMC V-STR CLASSIC XVS1100L/LC/M/MC V-STAR XV1600AL/ALC/AM/AMC ROAD STAR XV1600ATL/ATLC ROAD STAR SILVER XV1600ATM/ATMC ROAD STAR SILVER XV1600ALM/ALMC ROAD STAR MM L	98-99 00 99-00 00 99-00 99-00 99-00 99 00 00
RGU-211A	XV750J1/JC1 VIRAGO XV1100J/JC/K/KC/L/LC VIRAGO XV1100SJ/SJC/SK/SKC VIRAGO	97 97-99 97-98
RGU-212	XV920RH/RJ	81-82
RGU-213	YP250 MAJESTY YP250 MAJESTY DX XJ600S DIVERSION XJ600N XJ600N	96-98 98-00 96-02 95-97 99-01
RGU-215	XS750D/2D XS750E/F XS750SE/SF SPECIAL XS850G/H XS850LG/LH XS850SG/SH SPECIAL XS1100E/F/G/H XS1100SF/SG/SH SPECIAL XS81100LG/LH MIDNIGHT SPECIAL	77 78-79 78-79 80-81 80-81 80-81 78-81 79-81 80-81
RGU-216	XJ550H/J/K MAXIM XJ550RH/RJ/RK SECA XS650G/H SPECDAIL II XS650SG/SH SPECIAL XS650SJ/SK HERITAGE SPECIAL	81-83 81-83 80-81 80-81 82-83
RGU-217	XT600Z	84
RGU-219	XVS850 DRAGSTAR CLASSIC XVS850 DRAGSTAR CLASSIC XVS850 DRAGSTAR FZ1000 FAZER	98-02 04-06 00-02 01-05
RGU-220	XVS1100 XVZ13TF VENTURE XVZ13LT ROYAL DELUXE XVZ13TF ROYAL STAR MIDN.V.	03-04 00-01 01 02-04
RGU-221	FZS600	02-03
RGU-222	FZ6 FZ6 S2 FZ6 NS FZ6 FAZER FZ6 FAZER S2 FZ6 FAZER ABS XP500 T-MAX XP500 T-MAX ABS	04-07 07-08 05-06 03-07 07-08 06-08 04-07 05-07
RGU-223	XV250G/GC XVZ13AH/AJ ROYAL STAR XVZ13AK XVZ13ATH/ATJ XVZ13LTJ XVZ13LTN	95 96-97 98 96-97 97 01
RGU-225	YZF-R6 YZF-R46 XT660X XT660R XJ6-N	03-05 05 04-09 04-09 09
RGU-227	VMX-12 V-MAX	96-06
RGU-228	XV535 VIRAGO	97-03

STOCK NO	MODEL APPLICATION	
RGU-230	DT125R	99-00
RGU-231	XV125'97-00 VIRAGO,XV250S '98-99 V	98-99
RGU-235	WR250F	07-09
	WR450F	07-09
SUZUKI		
RGU-301	GS750ET/EX/EZ	80-82
	GS750LN/LT/LX	79-81
	GS750SD	83
	GS850GN/GT/GX	79-81
	GS850GLT/GLX/GLZ	80-82
	GS1000ET	80
	GS1000GX/GLX	81
	GS1000ST	80
	GS1000SZ	82
	GS1100ET/EX	80-81
	GS1100LT	80
	GS1100SD	83
RGU-302	GV1400	
RGU-303	TL1000S	99-00
	TL1000R	99-00
RGU-304	SV650X/Y	99-00
	LS650T/V/W/X/Y	96-00
RGU-305	DR250	90-95
	DR350	90-99
RGU-306	LT160EK/EL/EM/EN	89-92
	LT-F160M-K1	91-01
	LT-F250J-T	88-96
	LT-F250V-K1	97-01
	LT-F250FX/FY/FK1	99-01
	LT-F300FX/FY/FK1	99-01
RGU-307	LT-F300FK2	02
	LT-F250FK2	02
RGU-311	GN125E	92/94
	GZ125 MARAUDER	98-00
	GZ125 MARAUDER	03-04
	GN250	94
	GN250	96
	GZ250 MARAUDER	99-07
KAWASAKI		
RGU-401	ZX750E1/E2 GPZ TURBO	84-85
	KZ1000J1/J2/J3	81-83
	KZ1000K1/K2 LTD	81-82
	KZ1000M1/M2 CSR	81-82
	KZ1000P1-P5	82-86
	KZ1000P6-P10	87-91
RGU-401	KZ1000P11-P17	92-98
	KZ1000R1/R2 REPLICA	82-83
	KZ1100A1/A2/A3 SHAFT	81-83
	KZ1100B1/B2 GPz	81-82
	KZ1100D1/D2 SPECTRE	82-83
	KZ1100L1 LTD	83
RGU-402	ZX1100A1/A2 GPz	83-84
	EL250B2/B3 ELIMINATOR	88-89
	EL250E1-E4 ELIMINATOR250	91-94
	EX250E1/E2 NINJA 250R	86-87
	EX250F2/F3/F4 NINJA 250R	88-90
	EX250F6-F9 NINJA 250R	92-95
	EX250F10-F12 NINJA 250R	96-98
	EN450A1-A6 LTD454	85-90
	EN500A1-A7 VULCAN	90-96
	EN500C1-C3 VULCAN 500LTD	96-98
	EX500A1-A7	87-93
	EX500D1-D5 NINJA 500	94-98
	KZ550A4	83
	KZ550C4 LTD	83
	KZ550F1 SPECTRE	83
	KZ550F2 LTD	84
	KZ550H2	83
	KZ550M1 LTD	83
	KZ750F1 LTD (4CYL)	83
	KZ750N1/N2 SPECTRE	82-83
EX400A GPZ400S)A1	87	
RGU-403	ZL600A1/A2 ELIMINATOR	86-87
	ZX600A1-A3 NINJA600R	85-87
	ZX600B1 NINJA 600RX	87
	ZX600C1-C6 NINJA 600R	88-93
	ZX600D1 NINJA ZX-6	90
	VN700A1 VULCAN	85

STOCK NO	MODEL APPLICATION	
RGU-403	ZN700A1-A2 LTD	84-85
	VN750A2-A9 VULCAN	86-93
	ZR750C1-C3	91-93
	ZN1100B1/B2 LTD	84-85
	VN1500A1-A5 VULCAN 88	87-91
	VN1500B1-B6	87-92
	ZX400H1/H2	89-90
	ZX400J1/J2	89-90
	ZX400L1-L3	91-93
	ZX400G1/G1A	88
	ZX400F1	87
	ZX400E1/E2	86-87
	ZX400D3/D3A	87
	RGU-404	ZL600B2/B3 ELIMINATOR 600
ZX600C7-C10 NINJA 600R		94-97
ZX600E1-E11 NINJA ZX-6		93-03
ZX600E12H-E13H		04-05
ZX600F1-F3 ZX-6R		95-97
ZL600 B1 ELIMINATOR		95-97
ZR750 H1-H3 ZR-7S		01-03
ZR750F1-F5 ZR-7		99-03
ZR750 C1-C4 ZEPHYR		91-94
VN750A10-A14 VULCAN		94-98
VN1500A8-A9 VULCAN		92-95
VN1500A10-A12 VULCAN		96-98
VN1500C1-C4 VULCAN		94-97
ZX400L4-L9	94-99	
RGU-407	KL250D2-D6 KLR250	85-89
	KL250D7-D11	90-93
	KL250D12-D15	93-98
	KL600A1 KLR600	84
RGU-408	ZR550B1-B4	90-93
	ZX550A1-A2 GPZ	84-85
	ZX550A3 GPZ	86
	KL600B1/B2 KLR	85-86
	KL650 A1-A14 KLR	87-00
	KL650B2/B3 TENGAI KLR	90-91
ZX750A1-A3 GPZ	82-85	
ZX600D2-D4	91-93	
RGU-411		
RGU-413	ZX6000 G1/G2 NINJA ZX-6R	98-99
	VN800C1-C2	99-01
	VN800B1-B8	96-03
	VN800B9P-B10P	04-05
VN800A1-A4	95-98	
RGU-414	ZX900 C1/C2 NINJA ZX-9R	98-99
RGU-415	ZX636A1	02
	ZX600J1/J2	00-01
RGU-416	KDX200H1-H8	95-02
	KDX220A4-A9	00-01
	KDX200E4-E6	92-93
RGU-417	ZR1000A1-A3	03-05
	ZR750K1 <Z750S>	05
RGU-418	ER-5 'A1-A4	97-00
	ER-5 C1-C3	01-03
	ER-5 C4P-C5P	04-05
RGU-419	ZX-6R B1/B2 (ZX-636)	04-05
	ZX-6RR K1	03
	ZX-6RR M1	04
RGU-420	ZX900E1/F2	00-01
	ZX900F1	02
	ZX1200B1	02
	ZX1200A1H/A2H	00-01

REMARKS

RGU-106R was superseded by RGU-107
 RGU-211 WAS SUPERSEDED BY RGU-211A
 RGU-138 was superseded by RGU-144
 RGU-218 was superseded by RGU-219

REMARKS

RGU-109 RGU-124 RGU-145
 RGU-203 RGU-205 RGU-207
 RGU-214 RGU-232
 RGU-151 RGU-405 RGU-410
 The factory will stop the production.
 Last order will be accepted by September 25,2009.

SILICONE RECTIFIER



STOCK NO	MODEL APPLICATION	
REC-101	CB550F	76-77
	CB550K	77-78
	CB550SC NIGHTHAWK	83
	CB650	79
	CB650SC	83-85
	CB700SC	84-86
	CB750SC	82-83
	CX650T TURBO	83
	NT650 HAWK-GT	88-91
	CB750K	76-82
	CB750L	79
	CB750C CUSTOM	80-82
	CB750F SUPERSPORT	77-82
	CB900C CUSTOM	80-82
	CB900F SUPER SPORT	81-82
	CB1000C CUSTOM	83
	CB1100F	83
	CBX SUPER SPORT	81-82
	VF500F INTERCEPTOR	84-86
	VF700F INTERCEPTOR	84-85
	VF700C MAGNA	84-86
	VF700S SABRE	84-85
	VF750C MAGNA	82-83
	VF750S SABRE	82-83
	VF750C MAGNA	88
	VF750F INTERCEPTOR	83-84
	VFR700F INTERCEPTOR	86
	VFR700F2 INTERCEPTOR	86-87
	VFR750F INTERCEPTOR	86-87
	VF1100S SABRE	84-85
	VF1100C CUSTOM	83-86
	VF1100F INTERCEPTOR	84
	VF1100R	85-86
	VT600C SHADOW	88-89
	VT700C SHADOW	84-87
	VT750C SHADOW	83
	VT800C SHADOW	88
	VT1100C SHADOW	85-96
	VT1100C2 SHADOW AMERICAN	95-96
	GL500 SILVER WING	81-82
	GL500 I SILVERWEING	81-82
	GL650 SILVERWING	83
	GL650I SILVERWING	83
	GL1500 GOLDWING	88-90
	GL1500SE GOLDWING	90-91
	GL1500A GOLDWING AS	91
	GL1500I GOLDWING IN	91
	GL1500I GOLDWING IN	94-96
	GL1500CF VALKYRIE INT.	99-00
	PC800 PACIFIC COAST	89
	CBR1000F	87-88

STOCK NO	MODEL APPLICATION	
REC-103	CB750 NIGHTHAWK	91-96
	CB1000	94-95
	CBR600F2	91
	CBR900RR	93-95
	CBR1000F	90-95
	VF750C MAGNA	94-00
	VF750CD MAGNA DELUXE	95-96
	VF750C2 MAGNA DELUXE	98-00
	VFR750F INTERCEPTOR	90-95
	VT600C SHADOW	91-94
	VT600C SHADOW VLX	95-97
	VT600CD SHADOW DELUXE	93-94
	VT600CD SHADOW-VLX DELUXE	95-98
	VT1100C SHADOW SPIRIT	95-00
	VT1100C2 SHADOW AMERICAN	95-99
	VT1100C3 SHADOW AERO	98-00
	VT1100D2 SHADOW AMERICAN	99
	VT1100T SHADOW AMERICAN	98-00
	PC800 PACIFIC COAST	90
	PC800 PACIFIC COAST	94-96
	ST1100	95-00
	ST1100A	95-00

STARTER RELAYS

YAMAHA



	SSR-201	SR185H/J	81-82	
		XT225D/DC/E/EC/F/FC/G/GC	92-95	
		XT225H/HC/J/JC/K/KC/L/LC	96-99	
		SRX250T/TC	87	
		XV500K VIRAGO	83	
		XV535T/TC/U VIRAGO	87-88	
		XV535A/AC VIRAGO	90	
		XV535E/EC/F/FC/G/GC VIRAGO	93-95	
		XV535 VIRAGO	96-99	
		XV535SF/SFC/SG/SGC VIRAGO	94-95	
		XV535S VIRAGO	96-97	
		XJ550H/J/K MAXIM	81-83	
		XJ550RH/RJ/RK SECA	81-83	
		FJ800L/LC/N/NC	84-85	
		TT600E	94-01	
		XT800EA/EAG/EB/EBC/ED/EDC	90-92	
		XT800EE/EEC/EF/EFC/EG/EGC	93-95	
		XT800E	96-02	
		XTZ600 TENERE	86-90	
		YX800S/SC/T/TCU/UC/W/WC/A		
		/AC RADIAN	86-90	
		XJ850G/H/J/K MAXIM	80-83	
		XJ850LH MIDNIGHT MAXIM	81	
		XJ850LJ/LK SECA TURBO	82-83	
		XJ850RJ SECA	82	
		XJ750J/K MAXIM	82-83	
		XJ750MK MIDNIGHT MAXIM	83	
		XJ750RH/RJ/RK SECA	81-82	
		XTZ750 SUPER TENERE	89-95	
		XJ900RK SECA	83	
		XJ1100J MAXIM	82	
		XVZ12TK VENTURE	83	
		XVZ12TDK VENTURE ROYALE	83	
		XVZ12L/KC2 VENTURE	84	
		XVZ12DL/DKC2/DN VENTURE ROYALE	84-85	
		SSR-202	XV250	88-90
			XV250	95-98
			XV250	99
			FZR400U/SUC/W/SWC/A/SAC	88-90
			FZ800S/SC/T/TC/U/UC	86-88
			FZR600W/RA/B/RD/RE	89-93
		FZR600RF/RG/RH/RJ/RK	94-98	
		FZ750N/S/SC	85-86	
		FZ750T/TC/U/UC	87-88	
		TDM850	91-95	
		FZR1000B/BC/A/AC/W/WC	89-91	
		FZR1000D/DC/E/EC/F/FC/G/GC	92-95	
		FJ1100L/LC/N/NC	84-85	
		FJ1200S/SC/T/TC/U/UC/W/WC	86-89	
		FJ1200A/AC/B/BC/DC/AD/ADC		
		/AE/AEC	90-93	
		VMX12N/NC/S/SC/T/TC V-MAX	85-87	
		VMX12U/UC/W/WC V-MAX	88-89	
		XVZ13DS/DSC/DT/DTC V.ROYAL	86-87	
		XVZ12T/TC/U/UC VENTURE	87-88	
		XVZ13DU/DUC/DW/DWC/DA/DAC		
		VENTURE ROYAL	88-90	
		XVZ13DB/DBG/DD/DDC/DE/DDE		
	VENTURE ROYAL	91-93		
	SSR-203	SR250G/H/I	80-82	
		SR250TH EXCITER	81	
		XS360C/D	76-77	
		XS400D/E/F	77-79	
		XS400G/H SPECIAL II	80-81	
		XS400J/K MAXIM	82-83	
		XS400RJ/RK SECA	82-83	
		XS400SG/SH SPECIAL	80-81	
		XS750D/2D/E/F	77-79	
		XS850G/H	80-81	
		XS850L/LH SPECIAL	80-81	
		XS850SG/SH MIDNIGHT SPECIAL	80-81	
		XJ1100J MAXIM	82	
		XS1100E/F/G/H	78-81	
	XS1100SF/SG/SH MIDNIGHT SP.	79-81		
	SSR-204	XJR1200	95-98	
		XJR1300	99-06	
		XJR1300M	00	
		XJR1300SP	99-01	
		FJR1300QA	06	
	SSR-206	YZF600R	95-99	
		YZF600R	00-02	
		TDM850	96-01	
		TRX850	96-97	
		MT-03	06-09	
		YP250 MAJESTY ABS	03	
		YP250 MAJESTY	00-03	
		XVS1100 DRAGSTAR	99-02	
		XVS1100 DRAGSTAR CLASSIC	00-03	
		XVS1100 DRAGSTAR CLASSIC	05-06	
		BT1100 BULLDOG	02-06	
	SSR-207	FZS600 FAZER	98-03	
		FZS600S FAZER	00-01	
		FZS600M	00	
		FZS1000 FAZER	01-05	
		FJR1300A	06-09	
		FJR1300A ABS	06-07	
		FJR1300AS	06-07	
		YZF-R6	99-02	

	SSR-207	YZF-R1	98-01	
		TDM900A	05-06	
		YP250RX	05	
		XV1700 WAR5RIOR	03-04	
		YP125R X-MAX	06-09	
		YP250R X-MAX	05-09	
		XTX1200 SUPER TENERE	10	
		VP250 X-CITY	07-10	
		SSR-208	YZF1000R	96-01
			XT660R	04-10
			XT660X	04-10
			XTZ660 TENERE	08-09
			XJ6F DIVERSION	10
			XJ6-N	09-10
			XJ6-S DIVERSION	09-10
			V-MAX 1700	09-10
			XP500 T-MAX	01-07
			XP500 T-MAX ABS	05-07
		YFM250XL/XLC Beat Tracker 2WD	99	
		YFM35AS Bruin 350 Auto 2WD	04	
		YFM35FAS Bruin 350 Auto 4x4	04	
		YFM35FAHS Bruin 350 Auto 4x4 Hardwo	04	
		YFM35BAT/BAV Bruin 2WD	05-06	
		YFM35FAHT Grizzly 4WD Hunter	05	
		YFM35FAT/FAV Bruin 350 4WD	05-06	
		YFM35FAHV Bruin 350 4WD Hunter	06	
		YFM350FGW Grizzly 350 4WD	07	
		YFM35GW Grizzly 350 2WD	07	
		YFM400AM/AMC/AN Kodiak 2WD	00-01	
		YFM400FAM/FAMC/FAN Kodiak 4WD	00-01	
		YFM400FAHM/FAHMC Kodiak 4WD Hunt	00	
		YFM400FM/FMC/FN/FP Big Bear 4WD	00-02	
		YFM400NM/NMC Big Bear 2WD	00	
		YFM400N/P Big Bear 2WD	01-02	
		YFM400HN Big Bear 2WD Real Tree Hunt	01	
		YFM400FHN/FHP Big Bear 4WD Real Tre	01-02	
		YFM400FAHN Kodiak 4WD Real Tree Hunt	01	
		YFM400HP Big Bear 2WD Hunter	02	
		YFM400FAP/FAR Kodiak 4WD	02-03	
		YFM400FHAP Kodiak 4WD Hunter	02	
		YFM400AR Kodiak 400	03	
		YFM400FAHR Kodiak 400 4x4 Hardwoods	03	
		YFM400NR Big Bear 400 2WD	03	
		YFM4AS Kodiak 400 2WD	04	
		YFM4FAS Kodiak 400 Auto 4x4	04	
		YFM4FAHS Kodiak 400 Auto 4x4 Hardwo	04	
		YFM40S Big Bear 2WD	04	
		YFM40FS Big Bear 400 4x4	04	
		YFM40FT/FV Big Bear 400 4x4	05-06	
		YFM4FAT/FAV Kodiak 400 4WD	05-06	
		YFM4FAHT/FAHV Kodiak 400 4WD Hunt	05-06	
		YFM4FGW Grizzly 400	07	
		YFM450FAR/FAS Kodiak 450 4WD	03	
		YFM450FAHR Kodiak 450 Real Tree	03	
		YFM45FAG Kodiak Auto 4x4	04	
		YFM45FAHS Kodiak 450 Auto 4x4 Hardwo	04	
		YFM450FAT/FAV Kodiak 450 4WD	05-06	
		YFM45FAHT/FAHV Kodiak 450 4WD Hunt	05-06	
		YFM45FSET Kodiak 450 4WD Black Carbo	05	
		YFM45FASEV Kodiak 450 4WD Special Ed	06	
		YFM45FGW Grizzly 450	07	
		YFM660FP/FR/FS Grizzly 660	02-04	
	YFM660FHP Grizzly 660 Hunter Edition	02		
	YFM660FPS Grizzly 660 Silver	02		
	YFM660FRGY Grizzly 4x4 Metallic Titanium	03		
	YFM660FHRH Grizzly Real Tree Hardwoo	03		
	YFM660FHRWL Grizzly Wetlands Hunter E	03		
	YFM660FHSWL	04		
	YFM660FHS Grizzly 660 Hardwoods Hunt	04		
	YFM660FLES Grizzly 660 Auto 4x4 Limite	04		
	YFM66FAT/FAV Grizzly 660	05-06		
	YFM66FASET/FASEV Grizzly 660 Special	05-06		
	YFM66FAHT Grizzly 660 Hunter	05		
	YFM66FAHWT Grizzly 660 Hunter Wetland	05		
	YFM66FAHDV Grizzly 660 Ducks Unlimite	06		
	YFM66FAHV Grizzly 660 Hunter Hardwoo	06		
	YFM66FGW Grizzly 660	07		
	YFM66FGHW Grizzly Hunter	07		
	SSR-209	GTS1000	93-04	
		GTS1000A	93-94	
		FZ6-N	04-05	
		FZ-NS	05	
		FZ-6 FAZER	04-05	
		FZ-6	04-07	
		FZ6 FAZER ABS	06-07	
		FZ6 FAZER S2 ABS	08	
		FZ6 FAZER S2	07-08	
		FZ-6 S/ST	05	
		FZ-6SS/SSC	04	
		XVS650	97-04	
		XVS650A	98-01	
		XV650A	04-05	
		XVS650S	04	
		XVS650AS	04	
		SVZ13 ROYAL STAR	96-00	
	XVZ13 ROYAL STAR VENTURE0	00		
	XVZ13TF/TFM	04		
	XVZ13CT/TF/TFM	05		

SSR-209	XV1700A	04-05
	XV1700ATL	04
	XV1700AT	05
	XV1700AM	04-05
	XV1700ATM	05
SSR-210	XJ900S	95-01
	XJ900SK	98
	XJ900SN	01
SSR-211	YZF-R1	02-06
	FJR1300	01-05
	FJR1300A	04-05
	XV1900 MIDNIGHT STAR	
	YFZ450S/T/V/W	04-07
	YFZ450LES Limited edition	04
	YFZ450SET Special Edition	05
	YFZ450SPV Special edition	06
	YFZ450SEW Special Edition	07
	YFZ450BBV/BBW Bill Balance Edition	06-07
SSR-212	YFM50S Raptor 50	04
	YFM50RT/RV/RW Raptor 50	05-07
	YFM80WS Raptor 80	04
	YFM80GT/GV/GW Grizzly 80	05-07
	YFM80RT/RV/RW Raptor 80	05-07
	YFM80GHV/GHW Grizzly 80 Hunter	06-07
	YFM125G Grizzly 125	04
	YFM125GT Grizzly 125	05
	YFM125GHT/GHV/GHW Grizzly 125 Hunt	05-07
	YFM125GH	06
	YFM125GW	07
	YFA1S/SC Breeze	04
	YFM35XS/XSC Warrior	04
	SSR-213	YFM350FXH/FXJ/FXK/FXL/FXM/FXMC
YFM350FXN/FXP/FXR/FXS/FXT Wolverine		01-05
YFM350FXH-MNH/FXJ-MNH		96-97
YFM350UH/UJ/UK Big Bear 2WD		96-98
YFM350UH-MNH Big Bear 2x4 Main & Ne		96
YFM350UJ-MNH		97
YFM350FWSJ Big Bear 4WD		97
YFM350FWJ-MNH		97
YFM350FWBJ-MNH		98
YFM350FWBJ/FWBK/FWBKC Big Bear 4		97-98
YFM400FWH-MNH/FWJ-MNH		96-97
YFM400FWH/FWJ Kodiak 4WD		96-97
SSR-214		YFM250XM/XMC/XN/XP/XR/XS Beat Tr
	YFM250M	00
	YFM250XHN Beat Tracker Real Tree Hunt	01
	YFM250XHP Beat Tracker	02
	YFM250BT Bruin 250	05
	YFM25BV Bruin 250 2WD	06
	YFM25BW Big Bear 250	07
	YFM35XV Wolverine 350 2WD	06
	YFM660RN/RNC/RP/RR/RS/RT Raptor	01-05
	YFM660RPB Raptor Limited Edition Black	02
	YFM660RLER	03
	YFM660RLES Raptor Limited Edition Blac	04
	YFM660RSET Raptor Limited Edition	05
	YBR250	07
	YBR250	09

SUZUKI

SSR-301		GS250TT/TX	80-81
		GS300LZ	82
		GS400B/C	77-78
		GS425N/EN	79
		GS425LN	79
		GS450LT/LX/LZ	80-82
		GS450TX/TZ/TXZ/TXD	81-83
		GS450ED	83
		GS450ED	83
		GS450ET/ST/EX/SX/EZ	80-82
		GS450LD	83
		GS550B/C/EC/N/EN	77-79
		GS550LN	79
		GS550ET/LT	80
		GS550TX	81
		GS550LX/LZ	81-82
		GS550MZ	82
		GS650EX/EZ	81-82
		GS650GX/GZ	81-82
		GS650GLX/GLZ/GLD	81-83
		GS650MD KATANA	83
		GS650GD	83
		GS750B/C/EC/N/EN	77-79
		GS750LN/LT/LX	79-81
		GS750ET/EX/EZ	80-82
		GS750TZ/TD	82-83
		GS850GN/GT/GX	79-81
		GS850GLT/GLX	80-81
		GS850GZ/GD	82-83
		GS850GLZ/GLD	82-83
		GS1000C/EC/N/EN	78-79
		GS1000ST/ET	80
		GS1000LN/SN	79
		GS1000GT/GX	80-81
		GS1000GLT/GLX	80-81
		GS1100LT	80
		GS1100ET/EX	80-81
		GS1100GZ	82
		GS1100EZ/ED	82-83
		GS1100GLZ/GLD	82-83

SSR-302		GSX600F	98-05		
		GSX750F	98-05		
		SV650	99-02		
		VZ800V/W/X/Y	97-05		
		RF900RT/RV	96-97		
		TL1000S	97-01		
		TL1000R	98-02		
		SSR-303		DL650 V-STORM	04-10
				DL1000K2-K6	02-10
				SV650	03-10
SV1000	03-07				
SSR-304		LT-F250 2WD Ozark	02-07		
		LT-F250 Quad Sport	02-07		
		HONDA			
SSR-101		CB1100SF	00-01		
		CB1300	05-07		
		CB1300A	05-07		
		CB1300F1	2003		
		CB1300F	2003		
		CB1300S	05-07		
		CB1300SA	05-07		
		CB600F	03-06		
		CB750F2	04-05		
		CB900F	02-07		
		CBF600S	04-06		
		CBF600SA	04-06		
		CBR1000F	96-99		
		CBR1100XX	97-06		
		CBR600F	94-94		
		CBR900RE	2001		
		CBR900RR	93-03		
		CN250R	94-99		
		GL1500C	97-03		
		GL1500CD	01-03		
		GL1500CT	97-00		
		NES125	00-06		
		NES150	00-06		
		NTV650	93-96		
		RVF750R	94-95		
		SA50	93-95		
		SES125	02-04		
		SES150	02-04		
		SGX50	97-01		
		SGX50S	97-01		
		SH125	01-04		
		SH150	03-04		
		ST1100	94-02		
		ST1100A	93-02		
		ST1100P	03-04		
SZX50S	98-01				
SZX50X	98-01				
VF750C	93-95				
VFR750F	93-97				
VFR800	02-08				
VFR800A	02-08				
VFR800F1	98-01				
VT1100C	94-95				
VT600C	93-95				
VTR1000SP	00-06				
VTX1800C1	05-08				
VTX1800C	02-04				
XL1000V	99-08				
XL1000VA	04-08				
XL125V	07-08				
XL650V	93-04				
XR750	93-00				

CARBON BRUSH (STARTER MOTOR)

CBS-101 5-10-12 	HONDA
	(1986) CMX450C
	(1983) VT500ED
	(83-84) VT500FT
	(83-86) VT500C
	(84-85) VF500
	(84-86) VF500F
	(1983) CB550SC
	(84-85) CB750SC
	(1982) CBX500FC
	(1987) XL600VH
	(84-85) VF700F
	(84-87) VF700C
	(84-85) VF700S
	(1986) VFR700F
	(86-87) VFR700F2
	(86-87) VT700
	(1986) VT750C
	(82-83) VF750CC/CD
	(82-83) VF750SC/SC
	(83-85) VF750FD/FE/FF
	(82-88) VF750C
	(82-85) VF750S
	(1986) VFR750F
	(1987) VFR750F2
	(1984) CBX750FE
	(87-88) CBR1000FH/FJ
	(85-93) VT1100C
	YAMAHA
	(81-82) XJ550RH/RK SECA
	(81-83) XJ550H/J/K
	(84-85) FJ600L/LC/N/NC
	(86-88) FZ600S/SG/T/TC/U/UC
	(1982) XS400SJ HERITAGE
	(1982) XS400/SE
	KAWASAKI
	(81-83) KZ440D2-D4
	(81-83) KZ440A1-A4 LTD
	(1985) EN450A1 LTD
	(80-83) KZ550A1-A4
	(82-83) KZ550H GP
	(80-83) KZ550C1-C4 LTD
	(1983) KZ550M1 LTD
	(1983) KZ550F1
	(81-83) KZ650H CSR
(1982) KZ750R1 GP	
(1983) KZ750L3	
(1983) KZ1100L1 LTD	
(87-89) EX500A1-A3	
(85-87) ZX600A1-A3	
(88-89) ZX600C1/C2	
(83-85) ZX750A1-A3	
(84-85) ZX750E1/E2 TURBO	
(86-87) ZX1000A1/A2	
(83-84) ZX1100A1/A2	
(86-98) VN750A2-A14	
(84-85) ZN1100B1/B2 LTD	
(86-88) ZG1000A1/A3 CONCOURS	
SUZUKI	
(83-85) GR650D/EX/E/XE	
(82-83) GS750TZ/TD/EZ	
(1982) GSX750EZ	
(82-84) GS850GZ/GD/GE	
(82-84) GS1100GZ/GD/GLZ/GE	
HONDA	
(78-79) CX500	
(80-82) CX500C	
(80-81) CX500D	
(1982) CX500TC	
(1983) CX500ED	
(1983) CX650C	
(83-84) CX650ED/EF	
(76-77) CB550F	
(76-78) CB550K	

CBS-102 6-14-12.5 	HONDA
	(78-79) CX500
	(80-82) CX500C
	(80-81) CX500D
	(1982) CX500TC
	(1983) CX500ED
	(1983) CX650C
	(83-84) CX650ED/EF
(76-77) CB550F	
(76-78) CB550K	

CBS-102	(78-81) CB650Z/B
	(80-82) CB650
	(80-81) CB650C
	(1982) CB650SC
	(82-83) CB750SC
	(76-78) CB750K
	(1979) CB750L
	(76-78) CB750F
	(80-82) CB750C
	(79-82) CB750FZ/FA/FB/FC/F2C
	(80-82) CB900C
	(79-82) CB900FZ/FA/FB/F2B/FC
	(82-83) CB900F2C/FD/F2D
	(79-82) CBX-Z/A/B/C
	(81-83) CB1100RB/RC/RD
	(84-86) VF1000R
	(84-85) VF1000FE/FF/FG
	(1985) VF1000F2F/F2G
	(1983) GL650ID/DD/D2D
	(76-79) GL1000/K1/K2/K3 LTD
	(80-83) GL1100
	(80-83) GL1100I
	(82-83) GL1100A
	(1982) GL1100C/IC/DC/AC
	(1983) GL1100D/ID/DD/D2D
	(84-85) GL1200
	(84-87) GL1200A
	(84-87) GL1200I
	(1985) GL1200L
	(1986) GL12SE-I
	(81-82) GL1500
	(81-82) GL1500I
	YAMAHA
	(76-78) XS500D/E
	(78-79) XS750F/E
	(78-79) XS750SE/SF
	(1980) XS750SE
	(80-81) XS850SG/LG/G/LH/H/S
	(78-81) XS1100E/F/G/H
	(79-81) XS1100SF/SH/LG/SG/LH
	(1982) XJ1100J MAXIM
	(84-85) XV700L/LC/N/NC
	(86-87) XV700CS/CSC/CT/CTC VIRAGO
	(81-83) XV750H/J/K VIRAGO
	(1983) XV750MK
	(88-89) XV750U/UC/W/WC VIRAGO
	(82-83) XV920K/J VIRAGO
	(81-82) XV920RH/RJ VIRAGO
	(1983) XV920MK MIDNIGHT VIRAGO
	(82-83) XV1000/SE
	(84-85) XV1000L/LC/N/NC
	(86-89) XV1100
	(84-86) FJ1100
	(86-87) FJ1200
	(1990) FJ1200
	(1984) FJ1200
	(1989) FJ1200
	(1983) XVZ12TK VENTURE
	(1983) XV12TDK
	(1984) XVZ12L/KC2
	(1984) XVZ12DL/DKC2
	(86-87) XVZ13DS/DT VENTURE ROYALE
	(87-88) XVZ13T/TC/U/UC VENTURE
	(88-90) XVZ13DVENTURE ROYALE
	(85-88) VMX12 V-MAX
(89-92) VMX12 V-MAX	
KAWASAKI	
(77-79) KZ650B	
(77-79) KZ650C	
(78-79) KZ650DSR	
(1980) KZ650F1	
(1980) KZ650E1 LTD	
(81-82) KZ650H1/H2	
(73-75) Z1	

CBS-102	(76-77) Z900A	
	(1976) KZ900B1 LTD	
	(80-82) KZ750E1-E3	
	(1980) KZ750G1 LTD	
	(1982) KZ750M1 CSR	
	(80-83) KZ750H1-H4	
	(83-84) KZ750K1/K2 LTD	
	(77-80) KZ1000B LTD	
	(78-80) KZ1000D Z1R	
	(77-80) KZ1000A	
	(81-82) KZ1000K LTD	
	(81-83) KZ1000M CSR	
	(1980) KZ1000G1	
	(79-80) KZ1000E ST & SHAFT	
	(81-83) KZ1000J1-J3	
	(81-83) KZ1100A	
	(81-82) KZ1100B GP	
	(87-92) ZG1200B1-B6	
	(79-82) KZ1300A1-A4	
	SUZUKI	
	(80-81) GS750LT/LX	
	(1981) GS750ET/EX	
	(1979) GS750LN	
	(79-81) GS850GT/GX/GN	
	(80-83) GS850GLT/GLX/GLZ/GLD	
	(1980) GS1000T/HT	
	(80-81) GS1000GT/GX/GLT/GLX	
	(78-79) GS1000C/EX/N/EN/HC	
	(1979) GS1000LN	
	GSX750T/ET/X/EX/LT/LX/SZ	
	CBS-103 6-9-12	YAMAHA
		(80-82) XJ650G/H/J
		(1981) XJ650LH
		(1982) XJ650RJ SECA
		(1983) XJ650K
		(1982) XJ650LJ SECA
		(1983) XJ650LK SECA-TURBO
		(1985) XJ700N/NC/XN/XNC
		(1986) XJ700XS/XSC MAXIM
(82-83) XJ750J/K MAXIM		
(81-83) XJ750RH/RJ/RK SECA		
(1983) XJ750MK MAXIM		
(1985) XJ750RN		
(1983) XJ900RK SECA		
(83-85) XJ900		
(95-02) XJ900S		
(1998) XJ900SK		
(01-02) XJ900SN/SP		
KAWASAKI		
(91-93) ZX600D2-D4		
(95-97) ZX600F1-F3		
(93-05) ZX600E1-E14		
(91-92) ZX750K1/K2		
(93-94) ZX750M1/M2		
(93-95) ZX750L1-L3		
(91-92) ZX750J1/J2		
(96-97) ZX750N1/N2		
(96-03) ZX750P1-P8		
(98-99) ZX900C1/C2		
(94-97) ZX900B1-B4		
(00-01) ZX900E1P/E2P		
(02-03) ZX900F1P/F2P		
(00-01) ZX1200A1/A2		
(02-03) ZX1200B1/B2		
(02-03) ZX1200B1H/B2H		
(03-05) ZR1000A1-A3 Z1000		
SUZUKI		
(82-83) GSX250Z/EZ/SZ/ESZ/ED/ESD		
(80-83) GS450LD/LT/LX/LZ		
(82-83) GS450GAZ/GAD		
(80-82) GS450ET/ST/EX/SZ/EZ		
(80-81) GSX400ET/ST/EX/SX		
(89-96) GS500E-K/L/M/N/P/R//S/T		
(97-03) GS500E-V/W/X/Y/k1/k2/k3		
(81-82) GS550X/EX/Z/EZ		
(80-82) GS550MZ/LX/LZ/ET/LT/TX/D		



CBS-103	(81-83) GS650GX/GZ/EX/EZ/GD/MD	
	(81-83) GS650GLX/GLZ/GLD	
	(81-82) GS650X/Z	
	(1980) GS1100LT/ET	
	(89-97) GSX750F KATANA	
	(1980) GSX1100T/ET/LT	
	(1981) GSX1100X/EX	
	(82-83) GSX1100EZ/A/ED/D/SE/ESD	
	(84-86) GSX1100E/ES/EF/E/F/G	
	(88-93) GSX1100F KATANA	
	(99-00) GSX1300X/Y	
	(99-04) GSX1300R HAYABUSA	
	(92-93) GSX-R600WN/WP	
	(88-91) GSX-R750J/K/L/M	
	(92-93) GSX-R750WN/WP	
	(95-98) GSX-R1100S/T/V/W	
	(90-94) VX800L/M/N/P/R	
	(92-00) VS800GL	
	(01-04) VS800GL	
	(01-05) VL800 INTRUDER VOLUSIA	
	(98-03) TL1000R-W/X/Y/K1/K2/K3	
	(98-01) TL1000S-V/W/X/Y/K1	
	(02-04) DL1000K2/K3/K4 V-STROM	
	(03-04) SV1000F3/K4	
	(03-04) SV1000SK3/SK4	
	(94-95) DR650SER/SES	
	(2003) AN650K3	
	(87-93) LS650F-G/J/K/L/M/N/P	
	(87-93) LS650P-G/J/K/L/M/N/P	
	(94-04) LS650P	
	CBS-104 6-12-11.5	HONDA
		(1982) CB250NDC/400NDC
		(78-79) CB400T
		(82-83) CM250C
		(85-87) CMX250C
		(1986) CMX250CD
		(79-81) CM400AZ/AA/AB
		(79-82) CM400TZ/TA/TB/TC
		(80-81) CM400E
(1982) CM450C		
(82-83) CM450E		
(82-83) CM450A		
(1982) CB450T		
(82-86) CB450SC		
YAMAHA		
(78-81) XS400E/F/G/H		
(80-81) XS400SG/SH		
CBS-105 6-10-12.7	HONDA	
	(89-90) VTR250	
	(91-00) CB250 NIGHTHAWK	
	(04-05) CMX250C	
	(1983) CX650T	
	(88-91) NTV600J/K/L/M	
	(88-91) NT650 HAWK GT	
	(83-85) CB650SC	
	(84-85) CB700SC	
	(98-05) NT650VW-V5	
	(88-97) NTV650J-V	
	(1988) XRV650J	
	(88-99) NX500J-X DOMINATOR	
	(88-99) NX650J-X DOMINATOR	
	(93-03) VF750C	
	(95-97) VF750CD	
	(97-00) VF750C2	
	(88-90) VFR750R	
	(90-97) VFR750F	
	(98-05) VFR800Fi	
	(02-05) VFR800A2-A5	
	(96-00) CB500T-Y	
	(98-02) CB500SW-S2	
	(91-93) CB750 NIGHTHAWK	
	(92-01) CB750F2N-F21	
	(89-90) PC800 PACIFIC COAST	
	(98-05) CB600F HORNET	
(00-02) CB600F2Y-F22 HORNET		
(04-05) CBF600N4/N5		



CBS-105	(04-05) CBF600NA4/NA5
	(04-05) CBF600S4/S5
	(04-05) CBF600SA4/SA5
	(02-05) CB900F HORNET
	(93-96) CB1000FP-FT
	(00-01) CB1100SFY/SF1
	(2003) CB1300F SUPER FOUR
	(2003) CB1300F13 SUPER FOUR
	(2005) CB1300-5/A5 SUPER FOUR
	(2005) CB1300S4/SA5
	(87-97) CBR600F
	(91-94) CBR600F2
	(95-98) CBR600F3
	(1996) CBR600SJR
	(1998) CBR600SE
	(92-01) CBR900RR
	(2001) CBR900RE
	(90-99) CBR1000F
	(97-05) CBR1100XX BLACKBIRD
	(90-02) ST1100
	(92-02) ST1100A
	(02-04) ST1300
	(02-04) ST1300A
	(98-04) VTR1000F SUPER HAWK
	(00-04) VTR1000SP
	(88-97) VT600C
	(00-05) VT600C
	(95-98) VT600CD DELUXE
	(00-05) VT600CD DELUXE
	(2000) VT600CD2
	(98-99) VT750C
	(2001) VT750C
	(04-05) VT750C
	(97-99) VT750C2
	(2001) VT750C2
	(98-99) VT750C3
	(2001) VT750C3
	(98-99) VT750CD DELUXE
	(98-99) VT750CD2 DELUXE
	(98-99) VT750CD3 DELUXE
	(2001) VT750CD3 DELUXE
	(01-02) VT750DC
	(2003) VT750CDA
	(02-03) VT750CDB
	(02-03) VT750CDC
	(02-03) VT750CDD
	(04-05) VT750CA
	(03-05) VT750DCA SPIRIT
	(03-05) VT750DCB SPIRIT
	(94-05) VT1100C
	(95-05) VT1100C2
	(1997) VT1100C2-2
	(98-02) VT1100C3
	(1999) VT1100D2
	(98-01) VT1100T
	(03-05) VTX1300S
	(2005) VTX1300R
	(04-05) VTX1300C
	(02-05) VTX1800R
	(02-05) VTX1800S
	(02-04) VTX1800C
	(04-05) VTX1800N
	YAMAHA
	(92-99) XJ600SD-SL
	(97-02) XJ600N
	(90-98) XV535 VIRAGO
	(99-01) XV535 VIRAGO
	(97-02) XVS650
	(98-05) XSV650A
	(93-94) GTS1000
	(93-94) GTS1000A
	(89-93) FZR600
	(90-99) FZR600RA-RL
	(1990) FZR750R/RA
	(89-95) FZR1000W-G
	(96-02) YZF600R

CBS-105	(96-01) YZF1000R
	(98-03) FZS600
	(1998) FZS600K
	(2000) FZS600M
	(2001) FZS600S/SN
	(2002) FZS600P
	(2003) FZS600R
	(01-04) FZS1000 FZ1
	(01-02) FZS1000N/P FZ1
	(03-04) FZS1000S FZ1
	(2005) FZS1000T FZ1
	(98-99) YZF-R1
	(82-83) TDM850
	(91-01) TDM850
	(01-05) TDM900
	(03-04) TDM900R/T
	(95-97) SZR660
	(94-01) TT600E
	(91-02) XT600E
	(92-96) XTZ660 TENERE
	(89-95) XTZ750 SUPER TENERE
	(91-97) FJ1200
	(91-97) FJ1200A
	(95-98) XJR1200
	(1997) XJR1200SP
	(99-04) XJR1300
	(1999) XJR1300SP
	(93-98) VMX12 V-MAX
	(99-05) VMX12LV-MAX
	(91-95) XVZ13D VENTURE ROYALE
	(1996) XVZ13A/AT ROYAL STAR
	(1997) XVZ13AAT ROYAL STAR
	(1997) XVZ13LTJ/LTJC ROYAL STAR
	(2000) XVZ1300A
	(2000) XVZ13TF
	(2001) XVZ13TF VENTURE
	(2001) XVZ13LT ROYAL STAR TOUR DELUXE
	(2002) XVZ13TFP/TFPC ROYAL STAR VENTURE
	(2002) XVZ13TFS ROYAL STAR MIDNIGHT
	(2004) XVZ13TFS/TFSC VENTURE
	(2004) XVZ13TFMS ROYAL STAR VENTURE
	(2005) XVZ13CTT/CTTC
	(2005) XVZ13TFT/TFTC
	(2005) XVZ13TFMT/TFMTC
	(1999) XV1600A
	(00-02) XV1600A ROAD STAR
	(2000) XV1600AL ROAD STAR MM LTD
	(01-02) XV1600AT ROAD STAR SILVERADO
	(2002) XV1600AS ROAD STAR
	(2001) XV1600AS MIDNIGHT STAR
	(2004) XV1700AT/AM
	(2004) XV1700ATLS/AS
	(2005) XV17AT/ATC/ATT/ATTC
	(2005) XV17AMT/AMTC/ATMT/ATMTC
	KAWASAKI
	(96-03) EN500C1-C8 LTD
	(97-99) ER500A1-A3
	(2001) ER500D1
	(99-02) EJ650A1-A4 W650
	(2003) EJ650C5
	(88-91) EX500B1-B4 GPZ500S
	(94-00) EX500D1-D7
	(2002) EX500E9 GPS500S
	(90-97) ZX600C3-C10
	(88-90) ZX1000B1-B3
	(90-93) ZX1100C1-C4
	(93-01) ZX1100D1-D9
	(95-97) ZX1100E1-E3
	(1996) ZX1100F1 GPZ1100
	(02-05) ZX1200C1H-C4H ZZR1200
	(91-94) ZR550B2-B5
	(91-94) ZR750C1-C4
	(99-03) ZR750F1-F5 ZR-7
	(01-04) ZR750H1-H4 ZR-7S
	(92-95) ZR1100A1-A4
	(97-00) ZR1100C1-C4 ZRX1100

CBS-105	(97-00) ZR1100D1-D4 ZRX1100
	(01-02) ZR1200C1P/C2P ZRX1200
	(01-03) ZR1200A1P-A3P ZRX1200R
	(01-03) ZR1200B1P-B3P ZRX1200S
	(89-91) KL650B1-B3 TENGAI
	(87-05) KL650A1-19 KLR
	(95-03) KL650C1-C9 KLR
	(93-96) KLX650C1-C4
	(95-05) VN800A1-A11
	(99-00) VN800G1/C2 DRIFTER
	(96-04) VN800B1-B9 CLASSIC
	(01-05) VN800E1-E5 DRIFTER
	(87-99) VN1500A1-A13
	(87-90) VN1500B1-B4 88 SE
	(1992) VN1500B6 VN-15SE
	(96-97) VN1500D1/D2 CLASSIC
	(94-97) VN1500C1-C4 VN-15L
	(98-99) VN1500G1/G2 CLASSIC TOURER
	(98-04) VN1500E1-E7 CLASSIC
	(99-00) VN1500J1/J2 DRIFTER
	(00-02) VN1500N1H-N3H CLASSIC Fi
	(99-01) VN1500G1/G2/G3 NOMAD
	(00-03) VN1500L1H-L4H CLASSIC TOURER Fi
	(02-03) VN1500P1H/P2H MEAN STREAK
	(00-04) VN1500L1-/L5 NOMAD Fi
	(2005) VN1500N4 CLASSIC
	(01-05) VN1500R1-R5 DRIFTER
	(03-05) VN1600A1-A3 CLASSIC
	(04-05) VN1600B1/B2 MEAN STREAK
	(04-05) VN2000A1/A2
	(2005) VN2000D1 LTD
	(89-05) ZG1000A4-A20 CONCOURS
	(93-03) ZG1200B7-B17 VOYAGER XII
	SUZUKI
	(93-96) RF600RP/RR/RS/RT
	(94-97) RF900RR/RS/RT/RV
	(97-03) VZ800V/W/X/Y/K1/K2/K3
	(88-98) GSX600F-J/K/L/M/N/P/R/S/T/V KATANA
	(91-93) GSX1100GM/GN/GP
	(1999) GSX1200X
	(94-95) GSX-R750WR/WS
	(89-95) GSX-R1100K/L/M/N/P/R/S
	(96-00) GSF1200ST/SV/SW/SX/SY BANDIT
	(96-00) GSF1200SAT/SAV/SAW/SAX/SAY BANDIT
	(01-05) GSF1200SK1/SK2/SK3/SK4/SK5 BANDIT
	(94-95) DR350SER/SES
	(96-05) DR650SE-T/V/W/X/Y/K1/K2/K3/K4/K5
(87-95) VS1400GLFH-GLFS	
(87-04) VS1400GLPH-GLPK4	
(98-05) VL1500W/X/Y/K1/K2/K3/K4/K5 INTRUDER LC	

CARBON BRUSH (ALTERNATOR



CBS-901		KAWASAKI	
14-7-5	ALTERNATOR CARBON BRUSH SET (2+2PC)		
	ZX750F1-F4	87-90	
	ZX750H1/H2 ZX-7	89-90	
	ZX750J1/J2	91-92	
	ZX750K1/K2	91-92	
	ZX750L1-L3	93-95	
	ZX750M1/M2	93-94	
	ZX750N1/N2	96-97	
	ZX750P1-P6	96-01	
	ZL900A1/A2	85-86	
	ZX900A1-A3	84-86	
	ZX900B1/B2/B3	94-97	
	ZG1000A1-A17	86-02	
	ZL1000A1	87	
	ZX1000A1/A2	86-87	
	ZX1000B1-B3	88-90	
	ZX1100C1-C4 ZX11	90-93	
	ZX1100D1-D9	93-01	
	ZX1100E1-E3	95-97	
	ZX1100F1	96	
	ZR1200A1 ZRX1200R	01	
	SUZUKI		
	GSF600S T/V	96-97	
	GSX600F J-V	88-97	
	GSX-R600W N/P	92-93	
RF600RR/RS/RT	94-96		
GSX750F K-T	89-96		
GSX-R750RG	86		
GSX-R750 G-N	86-92		
GSX-R750W P/R/S	93-95		
RF900R R/S/T/V	94-97		
RF900RZS	95-97		
GSX1100E J/K/L	88-90		
GSX1100F M/N/P	91-93		

supplied by set
2pc carbon brush
2pc spring

CBS-901		
GSX1100G M/N/P		91-93
GSX-R1100 G/H/J		86-88
GSX-R1100 K-N		89-92
GSX-R1100 W P-V		93-98
GSF1200S V-X		97-99
GSF1200SA V		97
YAMAHA		
FZ700T/TC		87
FZX700S/SC/T/TC		86-87
FZ750N/S/SC		85-86
FZ750U/UC		88
YZF750RF//RFC		94
YZF750RH/RJ		96-97
FZR750RT/RU		87
FZR1000'87-93		
FJ1100L/LC/N/NC		84-85
FJ1200S-B		86-93
FZR1000		95
GTS1000AE/AF		93-94
YZF1000RJ		96-01

CONTACT POINT & CONDENSERS DAIICHI

H HONDA
Y YAMAHA
S SUZUKI
K KAWASAKI



NO.		O.E.REF
CONTACT POINT SET		
DH-11	H	30202-003-015 30202-030-005
DH-24	H	30202-216-005
DH-29	H	30202-035-005 30202-041-005
DH-31	H	30202-041-015
DH-34L	H	30204-300-005/154
DH-34R	H	30203-300-005/154
DH-37	Y	132-8121-10 136-81121-10
DH-38	K	21082-010
	Y	183-81421-10/19
DH-39	Y	256-81621-10
DH-40	Y	256-81621-11
DH-41L	Y	371-81621-10
DH-41R	Y	371-81622-10
DH-42	Y	207-81321-10/11
DH-43	Y	434-81321-10
DH-44	Y	300-81321-10
DH-45	H	30202-397-005
	Y	443-81321-10
DH-47L	Y	1J7-81621-10
DH-47R	Y	1J7-81622-10
DK-1	H	30202-001-013
DK-13	H	30202-028-003
DK-16	H	30202-216-003
DK-17L	H	30204-283-003
DK-17R	H	30203-283-003
DK-19	H	30202-035-003
	K	21008-001
DK-2	H	30202-003-003 30202-030-003
DK-20	S	32240-07020
DK-22	K	21008-006 21008-016 21008-020
	S	32240-07610
DK-24L	H	30204-292-003
DK-24R	H	30203-292-003
DK-25	K	21008-019
	S	31440-15020
DK-27L	K	21008-022
DK-27R	K	21008-021
DK-31C	S	33170-34020
DK-31R/LS	S	33160-34020
DK-32	S	33172-33020
DK-34	S	32240-03120
DK-36	S	32240-12020
DK-38	H	30230-705-000

NO.		O.E.REF
DK-39L	S	33160-45020
DK-39R	S	33140-45020
DK-40	S	32240-07022
DK-41	K	21008-2002
DK-43	S	32240-04420
DK-44	H	30202-436-003
DK-45	S	32240-13020
DM-21	Y	109-81321-20 122-81321-20
DM-24	H	30202-001-106
	K	21008-002
DM-31	K	21082-006
DM-48	Y	131-81221-20
DM-50	Y	214-81321-20
DM-55	K	21008-018
DM-56L	Y	278-81321-20
DM-56R	Y	278-81622-20
DM-57	K	21082-007
DM-69	Y	437-81321-20
DM-75	S	32240-12130
DM-77	Y	1A0-81621-20
DM-78	S	32240-12030 32240-46130
	Y	120-81321-20 2A6-81321-20
DM-79	H	30202-035-006 30202-035-016 30202-147-008
	K	21008-024
DM-81	Y	1M1-81321-20 438-81321-20
DM-82	Y	296-81321-21 1V1-81321-20
DM-83	K	21008-1004
	Y	2F5-81321-20 1K8-81321-20
DM-84	H	30202-147-004
DM-87	Y	481-81321-MO
DN-1	H	30202-001-024
DN-22	H	30202-028-004 30202-052-004 30202-216-004
DN-23	H	30202-035-004
	S	32240-03010
DN-30	H	30202-044-000
	H	30202-063-004
DN-31	H	30202-230-004
DN-33L	H	30204-286-004/154
DN-33R	H	30203-286-004/154
DN-40	H	30202-107-004
DN-42	S	32240-28010

NO.		O.E.REF
DN-42	S	32240-12010
DN-43L	H	30204-333-004
	S	31440-36210
DN-43R	H	30203-333-004
	S	33172-36210
DN-44C	S	33160-31010
DN-44R/LS	S	33170-31010
DN-46C	S	33160-33010
DN-46R/LS	S	33170-33010
DN-51	K	21008-023 21008-025
DN-52	H	30202-041-004
DN-55	H	30202-131-004
DN-59L	S	33160-44010
DN-59R	S	33140-44010
DN-60	S	33140-32410
	Y	583-81621-50
DN-61	K	21008-1011
	S	32240-43012
DN-62	H	30202-122-004
DN-63	H	30202-171-004
DN-65L	Y	1L9-81621-50/51
DN-65R	Y	1L9-81622-50/51
DN-66	H	30202-041-315
DN-9L	S	31460-09010
DN-9R	S	31440-09010
DT-2	H	30202-039-154
DT-24L	H	30204-292-154
DT-24R	H	30203-292-154
DT-27L	K	21008-027
DT-27R	K	21008-028
DT-28L	H	30202-399-000
DT-28R	H	30203-399-000
DT-29	K	21008-1002
DT-3	H	30202-179-711
DT-33L	H	30202-369-154
	K	21008-1009
DT-33R	H	30203-369-154
	K	21008-1010
DT-4	H	30202-174-671
DT-40	H	30202-107-154
CONDENSEERS		
DHO-18	Y	1J7-81625-10
DHO-1	H	30250-035-005 30250-041-005
	Y	254-81326-10
DHO-10	Y	183-81425-10
DHO-11	Y	256-81625-10
DHO-12	Y	371-81625-10
DHO-13	Y	341-81625-10

NO.		O.E.REF
DHO-14	H	30250-329-305
DHO-17	Y	148-81126-10
DHO-19	Y	1A0-81625-10
DHO-4	Y	104-81326-10
DHO-5	Y	207-81326-10
DHO-6	Y	132-81225-10
DHO-7	Y	132-81226-10
DHO-8	Y	277-81326-10
DHO-9	Y	132-81426-10
DKO-10	S	32341-07020
DKO-11L	S	31642-18521/22
DKO-11R	S	31641-18521/22
DKO-12	H	30250-369-003
DKO-13	H	30250-330-003
DKO-14	K	21013-029
DKO-15	K	21013-030
	S	32341-07610
DKO-17	S	32341-34020
DKO-18	S	32342-34020
DKO-19	S	32343-34020
DKO-20	S	33261-33020
DKO-21	S	33262-33020
DKO-22	S	33263-33020
DKO-24	S	32341-25690
DKO-25	K	21013-026
DKO-26	K	21013-035
DKO-27	H	30280-357-003
DKO-28	H	30250-074-003
DKO-29	S	33261-45020
DKO-3	H	30250-001-013
DKO-32	K	21013-037
DKO-33	S	31640-36220
DKO-34	S	32341-25700
DKO-35	H	30250-397-300
DKO-36	S	33421-44020
DKO-37	S	32341-04020
DKO-38	H	30250-436-000
DKO-39	S	32341-22020
DKO-4	H	30250-052-000
DKO-5	H	30250-028-000
	H	30250-028-003
	H	30250-028-004
DKO-6	H	30250-216-000
DKO-7	H	30250-273-003
	H	30280-292-670
DKO-8	S	32341-03020
DMO-10	Y	169-81125-20
DMO-11	Y	169-81126-20
DMO-12	Y	360-81625-20
DMO-13	Y	168-81225-20
		278-81625-20
DMO-14	Y	168-81226-20
		278-81626-20
DMO-20	K	21013-001
DMO-21	K	21013-006
DMO-26	K	21013-023
DMO-27	K	21013-025
DMO-29	Y	296-81325-20
DMO-3	Y	104-81326-20
DMO-30	Y	654-81325-20
DMO-33	K	21013-1001

NO.		O.E.REF
DMO-33	Y	1K8-81325-20
		511-81325-20
DMO-35	K	21013-033
DMO-36	H	30250-035-006
		30250-006-006
	Y	1V1-81325-50
DMO-37	Y	2F5-81325-20
DMO-38	S	32341-26030
DMO-40	Y	481-81621-MO
DMO-7	Y	214-81326-20
DNO-1	H	30250-001-024
DNO-10	H	30250-333-004
DNO-11	H	30280-286-701
DNO-12	H	30250-041-004
DNO-14	S	31641-01310
DNO-16	S	32341-12010
	S	32341-12011
DNO-17	S	31641-09010
DNO-20	S	33261-33010
DNO-21	S	32341-31010
DNO-23	H	30250-360-004
DNO-25	H	30250-362-003
DNO-26	K	21013-031
DNO-27	K	21013-034
DNO-28	Y	1L9-81625-50
DNO-29	S	31642-36110
DNO-30	S	31642-09010
DNO-31	Y	583-81625-50
DNO-32	S	31641-36210
DNO-33	S	31642-36210
DNO-34	S	32341-03110
DNO-35	K	21013-1005
	S	32341-43012
DNO-37	K	21013-036
DNO-38	H	30250-402-000
DNO-4	H	30250-107-000
DNO-5	H	30280-235-000
DTO-1	H	30280-292-672
DTO-10	H	30250-089-671
DTO-2	H	30280-371-000
DTO-3	H	30250-300-154
		30250-300-005
DTO-4	H	30250-052-156
DTO-5	H	30250-369-004
DTO-6	H	30280-237-154
		30280-237-005
DTO-7	K	21013-1002
		21013-1004
DTO-9	H	30250-383-720
BREAKER ASSEMBLY		
DN-40B	H	30200-107-014
DN-22B	H	30200-216-000
DN-22B1	H	30200-303-004
DN-33B	H	30200-286-004
DH-34B	H	30200-300-005
		30200-300-015
DH-34B2	H	30200-300-154
DH-34B1	H	30200-323-005
DT-1B	K	21135-011

PULSER COIL

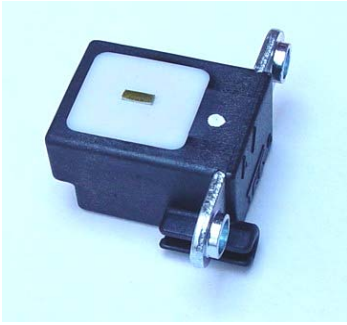

PCL-901	CLR125W	98
	NX2502L	90
	NX2502P	93
	NX250(J-M)	88-91
	NX250P	93
	KLR125RW	98
	XR250(RT-R4)	96-04

ELECTRIC PARTS (2)

WATER TEMPERATURE SENDING UNIT



WTS-101	Part Number	Year
	CB1000 FP-T	(93-96)
	CB500	2002
	CB500R	1994
	CB500S W-Y	(98-00)
	CB500S2	2002
	CB500 T-Y	(96-00)
	CB600F W-2	(98-02)
	CB600F2 Y-2	(00-02)
	CBF500	2004
	CBF500	2006
	CBF500A4	2004
	CBF500A6	2006
	CBR1000F H-N	(87-92)
	CBR1000F P-X	(93-98)
	CBR1100XX V-W	(97-98)
	CBR500F H-M	(87-91)
	CBR600FM	1991
	CBR600F2 M-R	(91-94)
	CBR600FS S-W	(95-98)
	CBR600F4X/F4Y	(99-00)
	CBR600F H-P	(87-93)
	CBR600F R-Y	(94-00)
	CBR600SET	1996
	CBR600SEW	1998
	CBR900RR N-V	(92-97)
	CH125J-T	(88-96)
	CN250H-M	(87-91)
	CN250P-X	(93-99)
	CRM125R L-R	(90-94)
	CRM125V/W/X	(97-99)
	FES125 W-2	(98-02)
	FES150 W-2	(98-02)
	FES250 W-2	(98-02)
	NSR125R K-S	(89-95)
	NSR125R V-1	(97-01)
	NSR125F J-P	(88-93)
	NSR50FPFR/FS	(93-95)
	NSR50RV/RW/RX	(97-99)
	NSR50SK	1989
	NSR50SP/SR/SS	(93-95)
	MTX125RWH	1987
	MTX125L	1990
	NSS250	(01-04)
	NSS250A	(01-04)
	NX250J-P	(88-93)
	NX250-2L	1990
	NX250-2P	1993
	NV400CS	1995
	NV400CV	1997
	NV600CP/CR	(93-94)
	NTV600J/K/L/M	(88-91)
	NTV650J-V	(88-97)
	PC800K/L	(89-90)
	ST1100L-T	(90-96)
	ST1100V-2	(97-02)
	ST1100PP	1993
	ST1100PS/PT	(95-96)
	ST1100PY	2000
	ST1100A N-V	(92-97)
	ST1100A W-2	(98-02)
	VFR400R3L/R3M	(90-91)
	VF750CDT	1996
	VF750C P-2	(93-02)
	VF750C2 V-Y	(97-00)
	VFR750F H-N	(87-92)
	VFR750F P-V	(93-97)
	VFR750RJ/RK	(88-89)
	VT1100C2 S-Y	(95-00)
	VT1100C2 1-5	(01-05)
	VT1100C3 W-Y	(98-00)
	VT1100CH/CJ	(87-88)
	VT1100C N-W	(92-98)
	VF1100D2X	1999
	VT600CD P-X	(93-99)
	VT600C J-S	(88-95)
	VT600C T-X	(96-99)
	VTR1000F V-Y	(97-00)
	XL1000V X-2	(99-02)
	XL600V H-N	(87-92)

WTS-101	Part Number	Year
	XL600V P-X	(93-99)
	XL650V 1-6	(01-06)
	XRV650J/K	(88-89)
	XRV750 L-Y	(90-00)
	GL1500A M-Y	(91-00)
	GL1500CT V-X	(97-99)
	GL1500CV/CW/CX	(97-99)
	GL1500J/K/L	(88-90)
	GL1500SE M-S	(91-95)
	GL1500SE T-Y	(96-00)
WTS-102	GL1000K GOLDWING	1975
	GL1000 GOLDINGWING	(76-79)
	GL1000 LTD	1976
	GL1100 GOLDWING	(80-83)
	GL1100I INTERSTATE	(80-83)
	GL1100A ASPENCADE	1982
	GL1200 GOLDWING	1984
	GL1200I INTERSTATE	(84-87)
	GL1200A ASPENCADE	(84-85)
	GL500 SILVERWING	(81-82)
	GL500I INTERSTATE	(81-82)
WTS-301	RGV250K/L	89-96
	AN250	98-02
	AN400	99-02
	TS125	89-04
WTS-302	RF600R	93-96
	RF900R	94-07
	VS600GL	95-97
	VS800GL	92-95
	GSX-R600W	92-93
	GSX-R750SP	94
	GSX-R750W	92-95
	GSX-R1100W	93-96

FUEL PUMP POINT SWITCH

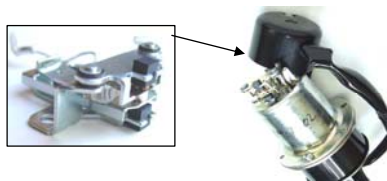

FPS-900	Description
	Available for Honda/Yamaha/Suzuki/Kawasaki DIAPHRAGM TYPE Fuel pump. (Not for IN-TANK TYPE)

OIL PRESSURE SWITCH



OPS-102	Part Number	Year
	CB900F	02-05
	CBR900RE	01
	CBR900RR	00-03
	CBR1000RR	04-06
	CBR1100XX	01-06

NEUTRAL SWICH ASSY

NUS-101	Part Number	Year
	NTV600	88-90
	NTV-650	88-97
	NTV650V	98-00
	NV400C	95
	NV400C	97
	NV600C	93-94
	NV750C2	01-02
	VT600CD	93-99
	VT600C	89-99
	VT600CD2	99
	XL600V	89-06
	XRV750	90-95
	XRV750	96-00
	VT750C	97-06
	VT750C2	97-01
	VT750C3	00-01
	VT750CD3	00-01
	VT750CA	05-06
	VT750DC	01-02
	VT750CA/CB	03

NUS-102



NUS-102	Part Number	Year
	CB1100SF	00-01
	CB500R	94
	CB500R	96-00
	CB500	02
	CB500S	98-00
	CB600F	98-06
	CB600F2	00-02
	CB900F	02-05
	CBF500	04-06
	CBF500A	04-06
	CBF600N	04-06
	CBF600NA	04-06
	CBF600S	04-06
	CBF600SA	04-06
	CBR600F	91-00
	CBR600F	01-06
	CBR600F2	91-94
	CBR600F3	95-98
	CBR600F4	99-03
	CBR600FR	01-02
	CBR600FS	01-02
	CBR600RR	03-06
	CBR600SE	96-98
	CBR900RE	01
	CBR900RR	92-00
	CBR900RR	01-03
	CBR1100XX	97-06
	NX500	89
	NX650	88-89
	RVF750R	94-05
	ST1100	94-02
	ST1100A	94-02
	ST1100P	95-96
	ST1100P	02
	VF750C	93-02
	VF750C2	97-00
	VF750CD	95-96
	VFR400R3	90-91
	VFR750F	87
	VFR750F	94-97
	VFR800Fi	99-01
	VFR800	02-06
	VFR800A	02-06
	VT1100C	94-98
	VT1100C2	95-05
	VT1100C3	98-00
	VT1100D2	99
	VTR1000F	97-06
	VTR1000SP	00-06
	VTX1300S	03-06
	VTX1800C	02-04
	VTX1800C1	05
	XL1000V	99-06
	XL1000VA	04-06
NUS-103	CB1000F	93-96
	CBR1000F	87-92
	CBR1000F	93-99
	CBR500F	87-91
	CBR600F	87-90
	GL1500	89-90
	GL1500	91-98
	GL1500SE	91-00
	GL1800A	01-05
	GL1800	06
	NSR125R	89-00
NUS-104	FMX650	05-06
	FX650	99-00
	NX500	90-99
	NX650	89-99
	SLR650	97-98
	ST1300	02-06
	ST1300A	02-06
	VT125C	99-06
	VT125C2	00-01
	XL125V	01-06
NUS-105	CB1300	05
	CB1300A	05
	CB1300F	03
	CB1300FI	03
	CB1300SA	05
	CB1000RR	04-06
	FL400R	89-90

CARBURETOR REPAIR KIT



*Different parts might be used in your market models.
Please check O.E. ref. number before ordering.



HONDA

CAB-H1	float needle	ref:16011-382-004
	chamber gasket	FBG-102
	o' rings	
	CB250T/N/NA/NC'78-80	
	CB400N/NA/NC'79-82	
	CB400T'78	
	CX500 '78-79	
	CX500C '79	
	CX500D '79	
	CB650Z'79	
	CB650'79-80	
	CB750KZ'79	
	CB900FZ'79	
	CB900FA'80 <VB51A(A)>	
	CBX Z-C'80-82	
CAB-H2	float needle	ref:16155-413-751
	chamber gasket	FBG-102
	o' rings	
	CB250NDC'82	
	CX500 A/B'80-81	
	CX500C A/B/C'80-83	
	CB650'81-82	
	CB750FA/FB/FC/F2C'80-81	
	CB750K'80	
	CB900FA'80 <VB51A(B)>	
	CB1100R B/C/D'81-83	
CB900FB/FC/F2C'81-82		
CAB-H3	float needle assy	ref:16011-MB0/MR6-671
	chamber gasket	FBG-104
	o rings	
	VF700 MAGNA'84-86	
	VF700F INTERCEPTOR'84-85	
	VT700C SHADOW'82-83	
	VF7050S SABRE'82-83	
	VF750C MAGNA'82-83	
	VF750F INTERCEPTOR'83-84	
	VT750C'83	
	VF1000F'84	
VT1100C'85-86		
CAB-H4	float needle assy	ref:16011-371-004/14
	chamber gasket	FBG-101
	o' rings	
CAB-H5	GL1000/K1/K2/K3 LTD '75-79	
	float needle assy	ref:16011-679-005
	chamber gasket	FBG-102
	o' rings	
	GL1100'80-83	
CBA-H6	GL1100A ASPENCADE'82-83	
	GL1100I INTERSTATE'80-83	
	float needle assy	ref:16011-MB1-671
CAB-H7	chamber gasket	FBG-104
	o' rings	
	GL1200A ASPENCADE'86-87	
CAB-H8	GL1200I INTERSTATE'86-87	
	float needle assy	ref:16011-MR6-671
	chamber gasket	FBG-104
CAB-H9	o' rings	
	NT650 HAWK GT'88-89	
	NTV650 J/K/M'88-91	
CAB-H10	float needle assy	ref:16011-MR1-004
	chamber gasket	FBG-104
	o' rings	
CAB-H11	VT600C SHADOW'88-89	

CAB-H15	float needle	
	chamber gasket	
	sub-chamber gasket	
	o' ring x 3	
	CBR600F	95-00
	CBR600F3	95-98
	CBR600F4	99-00
CAB-H16	CBR600SE	98
	CBR900RR	92-95
	float needle	
	chamber gasket	
CAB-H17	sub-chamber gasket	
	o' ring c 3	
	CBR900RR	96-99
	CBR1000F	93-99
	float needle	
	chamber gasket	
	sub-chamber gasket	
CAB-H18	o' ring x 3	
	CBR600F	93-94
	CBR600F2	93-94
	CB500	96-02
	CB500S	96-02
	CB600F	98-06
	CB600F2	00-02
	CB1000F	93-96
	VF750C	94-02
	VF750C2	97-00
	VF750CD	95-96
CAB-H19	float needle	
	chamber gasket	
	sub-chamber gasket	
	o' ring x 3	
	VFR750F	94-97
CAB-H20	float needle assy	ref:16011-MR6-671
	chamber gasket	FBG-104
	o rings	
	VT700C'87	
	VT800C SHADOW'88	

KAWASAKI

CAB-K1	float needle assy	ref:16030-027
	chamber gasket	FBG-901
	gasket	16019-031
	o' rings	
CAB-K2	KZ1000A1-A2'77-78	
	KZ1000B1-B2'77-78	
	KZ900A4/F5'76-77	
	float needle assy	16030-027
CAB-K3	chamber gasket	FBG-401
	gasket	16019-031
	o' rings	
	KZ1000A3/A4'79-80	
	KZ1000B3/B4'79-80	
	KZ1000C3/C4'80-81	
	KZ1000D3'80	

CAB-K3	float needle assy	ref:16030-1016
	chamber gasket	FBG-902
	o' rings	
	KZ750R1 GPZ'82	
	KZ750L3'83	
	ZX750A1/A2/A3'83-85	
	KZ1000M1/M2 LTD'81-82	
KZ1000K1/K2 LTD'81-82		
KZ1000J1/J2'81-82		
KZ1000R1/R2 REPLICIA'82-83		
CAB-K4	float needle/clip	ref:16030-1007
	chamber gasket	ref: 92055-1222 *round
	washer	
	screw	
	aluminum plug	
	spring	
	o' ring	
	EL250E1/E2'91-92	
	EX500B1-B4'88-91	
	EN500A1-A4 VULCAN'90-93	
	ZL600A1/A2 ELIMINATOR'86-87	
	ZX600A/B NINJA'85-87	
	ZX600C1-C6 NINJA'88-93	
	KL650B1-B3 TENGAI'89-91	
	ZX750G1/G2 GPZ750R'84-85	
	ZX750F1-F4 '87-90	
	ZL900A1-A2'85-86	
ZX900A1-A3 GPZ900R'84-86		
ZX1000A1'86		
ZL1000A1 ELININATOR'87		
ZG1000A1-A7'86-92		
ZG1200A1/B1-B6 VOYAGER XII'86-92		
CAB-K4	EX250H1-H5'90-94	
	EL250D4/D5'93-94	
	KL250D11'94	
	EX250E1/E2'86-87	
	EX250F2-F4'88-90	
	EX250F6-F7'92-93	
	EN450A1/A6 LTD'85-90	
	EX500A1-A7'87-93	
	ZR550B1-B3 ZEPHYR'90-93	
	ZR750C1-C3 ZEPHYR'91-93	
	ZR1100A1 ZEPHYR'92	
	KLX650C1-C2'93-94	
	KLX250E1/E2'93-94	
CAB-K5	float needle/clip	ref:16030-1007
	chamber gasket	FBG-403
	screw	ref:16014-1011
	spring	ref:92081-1002
	Aluminam plug	ref:92066-1051
	o' rings	
	KZ440A1-A4 LTD'80-83	
KZ440B1/B2'82-83		
KZ440D1-D5 LTD'80-83		
KZ440G1'82		
KZ750E1/E2/E3'80-82		
KZ750H1-H4 LTD'80-83		
KZ750N1/N2 SPECTRE'82-83		
CAB-K6	float needle assy	ref:16030-1024
	chamber gasket	ref:92055-1128
	aluminum plug	92066-1051
	o' rings	
	KZ550H1/H2'82-83	
	KZ550F1/F2'84-85	
CAB-K8	Z1,Z1A/B'73-75	
CAB-K9	float needle assy (2.4)	(16030-1072)
	chamber gasket	92055-1426
	Passage Plug	92066-1051
	o' rings	2 pcs
	ZX600D1-D4'91-93	
ZX600E1-E8'93-00		
CAB-K10	float needle assy(2.0)	16030-1076
	chamber gasket	92055-1426
	Passage Plug	92066-1051
	o' rings	2 pcs
	ZX750H1/H2'89-90	
ZX750L1-L3'93-95		

CAB-K10	ZX750J1/J2'91-92	
	ZX900P1-P5'96-00	
	ZX750B1-B3'94-96	
	ZX1000B1-B3'88-90	
CAB-K11	float needle assy(2.4)	16030-1077
	chamber gasket	92055-1426
	Passage Plug	92066-1051
	o' rings	2 pcs
ZX900C1/C2'98-99		
ZX1100C1-C4'90-93		
ZX1100D1-D8'93-00		
CAB-K12	float needle assy(2.0)	16030-1083
	chamber gasket	92055-1426
	Passage Plug	92066-1051
	o' rings	2 pcs
ZX600F1/F2/F3'95-97		
CAB-K13	float needle assy(2.0)	16030-1088
	chamber gasket	92055-1588
	Pilot screw set	16014-1100
	o' rings	3 pcs
	ZX600G1/G2'98-99	
ZX600J1/J2'00-01		
ZX636A1'02		
YAMAHA		
CAB-Y1	float needle assy	ref:353-14190-20
	chamber gasket	FBG-206
	o' rings	
	DT125MX	81
CAB-Y2	float needle assy	ref:168-14190-25
		23L-14107-25
	chamber gasket	FBG-206
	o' rings	
DT125LC'82		
CAB-Y3	float needle assy	ref:4L0-14190-25
	chamber gasket	FBG-206
	RD250LC'82	
RD350LC'82		
CAB-Y4	float needle assy	ref:29K-14190-28
		(48H-14107-28)
	chamber gasket	FBG-206
RD250 YPVS'83-85		
RD350 YPVS'83-85		
CAB-Y5	float needle assy	
	chamber gasket	
	o' rings	
	XS400'80-82	
	XS750SE'80	
	XS750 E/F/SF'78-79	
XS1100'80		
XS1100SE'81		
CAB-Y6	float needle assy	ref:3L1-14190-20
		(25G-14107-00)
	chamber gasket	3F7-14984-00
	o' ring for float needle	
	XS650SE'80-81	
	XS400SE'82	
XS650SG'80		
XS1100SG'80		
XS1100LG/LH/SH'80-81		
CAB-Y7	float needle assy	ref:3L1-14190-20
		(25G-14107-00)
	chamber gasket	FBG-201
	o' rings	
XJ550RH/RJ/RK SECA'81-83		
XJ550H/J/K MAXIM'81-83		
CAB-Y8	float needle assy	ref:4H7-14990-00
		(10I-14390-02)
	chamber gasket	FBG-204
	plug	4L6-14118-10
	XJ650G/H/J/K MAXIM'80-82	
	XJ650LH MIDNIGHT MAXIM	
	XJ650RJ SECA'82	
	XJ650'83	
XJ750RH/RJ/RK SECA		
XJ750J/K/MK MAXIM'82-83		

CAB-Y9	float needle assy	25G-14107-20
	chamber gasket	FBG-207
	O' ring	
	XJ600'84	
	XJ900'85	
CAB-Y10	float needle assy	ref:12R-14107-20
	chamber gasket	FBG-207
	o' rings	
	XJ900'83-84	
CAB-Y11	float needle assy	ref:168-14190-28
	chamber gasket	583-14184-00
	top cover gasket	583-14536-00
	o' rings	
	XT500	
CAB-Y12	float needle assy	ref:2H0-14190-28
	chamber gasket	2H0-14184-00
	top cover gasket	583-14536-00
	gasket	2H0-14198-00 x 2
	o' rings	SR500
CAB-Y13	float needle assy	ref:4X7-14390-00
		(10L-14390-02)
	chamber gasket	FBG-203
	XV750H/J/K/MK VIRAGO'81-83	
	XV920RH/RJ'81-82	
CAB-Y14	float needle assy	ref:2JN-14107-00
	chamber gasket	FBG-209 'ROUND TYPE
	gasket	5Y1-14198-00
	o' rings	
	XT600 H/N'87	
CAB-Y15	XT600Z'88-89	
	XT600EH'90-94	
	XT600EN'91-93	
	XT600E'94-98	
	XTZ660'91	
	XTZ660 H/N'92-93	
	float needle	3HH-14107-10
	chamber gasket	FBG-210
	rubber gasket	3GM-14147-00
	o' ring	FZR600'90-91
CAB-Y16	float needle assy	ref:1FN-14107-15
	chamber gasket	FBG-211
CAB-Y17	o' ring	FZR1000T
	float needle	ref:3GM-14107-17
	chamber gasket	FBG-210
	rubber gasket	3LF-14147-00
	o' rings	
	XTZ750'89-90	
	TDM850H/N'91	
	FZR750R'90	
	FZR1000B/BC'91	
	CAB-Y18	1FK-14190-15
22V-14147-00		GASKET
22U-14536-00		GASKET
22U-14147-00		O RING
93210-03119		O RING
214-14147-00		O RING
XV535A'90,94-95		
CAB-Y19	22U-141490-15	FLOAT VALVE ASSY
	22V-14147-00	CHAMBER GASKET
	22U-14536-00(3BJ)	CHAMBER GASKET
	22U-14147-00	
	93210-03119	
	214-14147-00	
	XV535A'90	
CAB-Y20	Float valve assy	25G-14107-20
	Chamber gasket	3XW-14984-00
		(12R-14984-00)
	o' rings	
	FJ600L/LC/N/NC'84-85	

CAB-Y21	Float valve assy	25G-14107-23
	chamber gasket	3XW-14984-00
		(12R-14984-00)
	O' RINGS	
	FJ1100L/N'84-85	
CAB-Y22	Float valve assy	4JM-14107-00
	chamber gasket	4JH-14984-00
	Pilot screw set	
	YZF600R'96-02	
CAB-Y23	Float valve assy	4SV-14107-15
	Chamber o ring	4XV-14562-00
	Pilot screw set	4SV-14105-00
	YZF1000R'96-01	
CAB-Y24	Float valve assy	4KM-14107-15
	Chamber o ring	4XV-14562-00
	Pilot screw set	4SV-14105-00
	YZF-R1'98-01	
CAB-Y25	Float valve assy	3CF-14107-15
	Float bowl gasket	3XW-14984-00
	o' ring(Pilot screw set)	(12R-14105-00)
	o' rings	2 pcs
	FJ1200'88-92	
CAB-Y26	Float valve assy	3CF-14167-15
	Float bowl gasket	3XW-14984-01
	o' ring(Pilot screw set)	(12R-14105-00)
	XV1100 VIRAGO'89-90	
CAB-Y27	Float valve assy	3CF-14107-15
	Float bowl gasket	3CF-14984-01
	o' ring(Pilot screw set)	(12R-14105-00)
	XV750 VIROGO'92-94	
CAB-Y28	Float valve assy	1FK-14190-15
	Float bowl gasket	22V-14147-00
	Sub gasket	22U-14536-00
	o' ring(Pilot screw set)	(12R-14105-00)
	o' ring	3 pcs
CAB-Y29	XV535 VIRAGO'89-98	
	XV535DX VIRAGO'99-01	
	Float valve assy	1FK-14190-15
	Float bowl gasket	22V-14147-00
	Sub gasket	3JB-14199-00
CAB-Y30	o' ring(Pilot screw set)	(12R-14105-00)
	o' rings	4 pcs
	VMX1200 V-MAX'86-03	
	VMX12 V-MAX'04-07	
	Float valve assy	1FN-14107-15
CAB-Y31	Float bowl gasket	1FN-14147-00
	o' ring(Pilot screw set)	(12R-14105-00)
	FZR1000'87-88	
	Float valve assy	3GM-14107-17
	Float bowl gasket	3GM-14997-00
CAB-Y32	Sub gasket	3LF-14147-00
	o' ring(Pilot screw set)	(12R-14105-00)
	o' rings	4 pcs
	XTZ750 TENERE'89-95	
	TDM850'91-95	
CAB-Y33	FZR1000'89-95	
	Float valve assy	4SV-14107-10
	Float bowl gasket	5DM-14561-00
	o' ring(Pilot screw set)	(5DM-14105-00)
	o' ring	1 pc
CAB-Y34	FZS600 FAZER'98-99	
	FZS600/600S FAZER'00-01	
	Float valve assy	4SV-14107-10
	Float bowl gasket	5DM-14561-00
	o' ring(Pilot screw set)	(5MP-14105-00)
CAB-Y35	o' ring	1pc
	FZS600 FAZER'92-93	
	Float valve assy	4KM-14107-15
	Float bowl gasket	5DM-14561-00
	o' ring(Pilot screw set)	(5MP-14105-00)
CAB-Y36	o' rings	2 pcs
	FZS1000 FAZER FZ1'01-05	

CAB-Y40	Float valve assy	5EL-14107-12
	Float bowl gasket	5DM-14561-00
	o' ring(Pilot screw set)	4XY-14105-00
	o' ring(Jet needle set)	(5KS-1490-00)
	o' rings	4 pcs
	XVS1100 DRAG STAR'99-02	
XVS1100A DRASTAR CLA.'00-06		
BT1100 BULLDOG'02-06		
CAB-Y41	Float valve assy	5EL-14107-23
	Float bowl gasket	5DM-14561-00
	o' ring(Pilot screw set)	(5EA-14105-00)
	o' ring(Jet needle set)	(5EA-1490J-10)
	o' rings	2 pcs
XJR1300'02-06		
CAB-Y42	Float valve assy	4SV-14107-20
	Float bowl gasket	5DM-14561-00
	o' ring(Pilot screw set)	(4WM-14105-00)
	o' ring(Jet needle set)	(5JA-1490J-00)
	o' ring	1 pc
XV1600A WILD STAR'99-03		
CAB-Y43	Float valve assy	3CF-14107-10
	Float bowl gasket	1HX-14147-00
	o' ring(Pilot screw set)	(4TR-14105-00)
	o' ring	1 pc
	XVS650 DRAG STAR'97-02	
XVS650A DRAG STAR CLS.'98-06		
CAB-S1	float needle assy	ref:13370-44080
	chamber gasket	FBG-902
	o' rings	
	GS550ET/LT/LX/LZ'80-82	
	GS550MZ(82)	
	GS550TX'81	
	GS650X/EX/Z/EZ'81-82	
	GS650GX/GZ/GD'81-83	
	GS650GLX/GLZ/GLD'81-83	
	GS650MD KATANA'83	
	GS850GT/TGX/GZ/GD'80-83	
	GS850GLT/GLX/GLZ/GLD'80-83	
	GS1000GT/GLT/GX/GLX'80-81	
	GS1000ET/ST'80	
	GSX750LT/LX'80-81	
GSX750T/ET/X/EX/EZ'80-82		
GSX1100ET/EX/EZ/ED/ESD'80-83		
GSX1100LT'80		
CAB-S2	float needle assy	ref:13370-45010
	chamber gasket	FBG-901
	gasket	13266-43010
	o' ring	
	GS550B/C/EC/N/EN/LN'77-79	
	GS750B/C/EC/N/EN/LN'77-79	
	GS850GN'79	
GS1000C/EC/N/EN/SN/LN'78-79		
CAB-S3	float needle assy	ref:13370-44500 (13370-27A00)
	chamber gasket	FBG-301
	gasket top cover	13266-27A00
	o' rings	
	GSX-R750 F/G/XG'85	
CAB-S5	float needle	13250-17C00
	chamber gasket	FBG-302
	o' rings	
	GSX-R750J'88 GSX-R1100 K/L'89-90 GSX750F K/L/M/N/P/R'89-94	
CAB-S6	float needle assy	ref:13370-44500 (13370-48B00)
	chamber gasket	FBG-303
	o' rings	
	GSX-R1100 G/H/J'86-88 GSX600F J/K/L/M/N KATANA'88-92	
CAB-S7	float needle assy	ref:13370-38B00
	chamber gasket	13251-38A10
	o' rings	
VX800L/UL		
CAB-S8	float needle assy	13370-44B00 (13370-02D00)
	chamber O RING	13258-44B00
	O RING	13374-44080
	O RING	13374-46710
	O RING	13509-17C00
	GS500E K-P '89-93	
	GSX1100G M/N'91-92	

CAB-S9	float needle assy	13370-46E00 (13370-07D00)	
	chamber O RING	13258-44B00	
	O RING	13278-02340	
	O RING	13374-46710	
	O RING	13374-44080	
	O RING	13295-29900	
	GSX-R750W N/P/R'92-94		
	GSX-R1100W P/R/S'93-95		
	CAB-S10	Float needle	13250-21E00
		Chamber o ring	13258-33C00
O RING		13251-33C00	
O RING		13251-06C10	
O RING		13294-33C00	
O RING		13278-47090	
O RING		13295-29900	
RF900R R/S'94-95 RF600R(U) P/R/S'93-95			
CAB-S11	Float needle assy	13370-37400	
	Chamber o ring	13251-38300	
	o' ring	2pcs	
LS650 SAVAGE'96-01			
CAB-S12	Float needle assy	13250-44C00(13D00)	
	Chamber o ring	13258-44B00	
	o' ring	4 pcs	
GSX600F L/M/N/P/R/S'90-95			
CAB-S13	Float needle assy	13370-20F00	
	Chamber o ring	13258-33E00	
	o' ring	3 pcs	
	SV650SX/SY/SK1/SK2'99-02 SV650X/Y/K1/K2		
CAB-S14	Float needle assy	13370-20F00	
	Chamber o ring	13258-33E00	
	o' ring	4 pcs	
VL800K1-K4'01-04			
CAB-S15	Float needle assy	13370-07F00(04F00)	
	Chamber o ring	13258-04F00	
	o' ring	4 pcs	
GSX600F W-Y'98-06			
CAB-S16	Float needle assy	13370-08F50(08F00)	
	Chamber o ring	13258-04F00	
	o' ring	5 PCS	
	GSX750F '98-06 KATANA GSF1200'01-06 BANDIT		
CAB-S17	Float needle assy	13370-04F00	
	Chamber o ring	13258-04F00	
	o' ring	4 pcs	
	GS500 K4-K6'04-06 XF650 X/Y'99-00 GZ250 '99-06		
CAB-S18	Float needle assy	13370-33E80	
	Chamber o ring	13258-33E00	
	o' ring	4 pcs	
GSX-R600 V-Y'97-00 GGX-R750 T/V'96-97			
CAB-S19	Float needle assy	13370-46E20	
	Chamber o ring	13258-44B00	
	o' ring	5 pcs	
GSF1200S V-Y'97-00			

NEW!

CAB-450	Float needle +clip	
	Float bowl gasket	
	Top cap gasket	
	Float bowl screw (4)	
	hon	CRF250R '04-09 CRF450R '03-08
	yam	YZ250F '03-10 YZ450F '03-09
	suz	RM-Z250 '04-09 RM-Z450 '05-07
	kaw	KX250F '04-10 KX450F '06-08
	ktm	250SX-F '05-10 450SX '06 450SXF '07-10

FLOAT BOWL GASKET

* O.E. number is mentioned for your reference.
 FBG includes Chamber gasket only



HONDA

FBG-101 RUBBER GASKET	75-79	GL1000 GOLDWING
	76	GL1000 LTD Goldwing
FBG-102 RUBBER O RING	82-83	CM250C CUSTOM
	'78	CM400A AUTOMATIC
	80-81	CB400T HAWK
	78-79	CB400TI HAWK I
	78-79	CB400TII HAWK II
	79-81	CM400A AUTOMATIC
	81	CM400C CUSTOM
	79-81	CM400T
	80-81	CM400E
	82-83	CB450SC NIGHTHAWK
	85-86	CB450SC NIGHTHAWK
	82	CB450T HAWK
	82-83	CM450A AUTOMATIC
	82	CM450C CUSTOM
	82-83	CM450E
	78-79	CX500
	79-82	CX500C CUSTOM
	78-81	CX500D DELUXE
	82-83	FT500 ASCOT
	81-82	GL500 SILVERWING
	81-82	GL500I SILVERWING INTERSTATE
	81-82	CB650
	81-82	CB650C CUSTOM
	82	CB650SC NIGHTHAWK
	83	CX650C CUSTOM
	83	GL650 SILVERWING
	83	GL650I SILVERWING INTERSTATE
	80-82	CB750C
	79-82	CB750K
	79-82	CB750F SUPERSPORT
	79	CB750L LTD
	82-83	CB750SC NIGHTHAWK
80-82	CB900C CUSTOM	
81-82	CB900F SUPERSPORT	
79-82	CBX	
83	CB1000C CUSTOM	
83	CB1100F SUPERSPORT	
80-83	GL1100 GOLDWING	
82-83	GL1100A GOLDWING ASPENCADE	
80-83	GL1100I INTERSTATE	
FBG-103 ROUND 'O' RING	73-74	CB350F/F1
	75-77	CB400F SUPERSPORT
	71-73	CB500/K1/K2
	74-75	CB550K/K1
	76	CB550
	77-78	CB550K
75-77	CB550F SUPERSPORT	
FBG-104 RUBBER 'O' RING	88-89	VT600C SHADOW
	91-97	VT600C SHADOW
	93-97	VT600CD SHADOW
	88-91	NT650 HAWK GT
	84-86	VF700C MAGNA
	84-85	VF700F INTERCEPTOR
	84-85	VF700S SABRE
	84-87	VT700C SHADOW
	82-83	VF750C MAGNA
	83-84	VF750F INTERCEPTOR
	82-83	VF750S SABRE
	83	VT750C SHADOW
	88	VT800C SHADOW
	84	VF1000F INTERCEPTOR
	85-86	VF1000R
	83-86	VF1100C MAGNA
	84-85	VF1100S SABRE

FBG-104	83-89	VT1100C SHADOW
	84	GL1200 GOLDWING
	84-87	GL1200A ASPENCADE
	84-87	GL1200I INTERSTATE

YAMAHA

FBG-201 GASKET	81-83	XJ550H/J/K MAXIM
	81-83	XJ550RH/RJ/RK SECA
	86-88	FZ600S/T/U
	86-88	YX600S/T/U
	89-90	YX600W/A RADIAN
FBG-202 GASKET	77-79	XS400D/E/F
	78	XS500E
	78-79	XS750E/SE/F/SF
	78-79	XS1100E/SE/F/SF
FBG-203 GASKET	81-83	XV750H/J/K VIRAGO
	83	XV750MK MIDNIGHT VIRAGO
	83	XV920K VIRAGO
	81-82	XV920RH/RJ EURO VIRAGO
FBG-204 GASKET	80-83	XJ650G/H/J/K MAXIM
	81	XJ650LJ MIDNIGHT MAXIM
	82	XJ650RJ SECA
	85-86	XJ700N/S MAXIM
	82-83	XJ750J/K
	83	XJ750MK MIDNIGHT MAXIM
81-83	XJ750RH/RJ/RK SECA	
FBG-205 GASKET	80-81	XS850G/H
	80-81	XS850LG/LH SPECIAL
	80-81	XS850SG/SH SPECIAL
FBG-206 GASKET	82	DT125LC
	82	RD125LC
	82	RD250LC YPVS
	82	RD350LC YPVS
	85	RD350 YPVS
	84-85	RZ350L/N
FBG-207 GASKET	82-83	XS400J/K MAXIM
	82-83	XS400RJ/RK SECA
	84-85	FJ600L/N
	85-86	XJ700XN/XS MASIM X
	83	XJ900RK SECA
	84-85	FJ1100L/N
	86-87	FJ1200S/T
	89-92	FJ1200W/A/B/D
92-93	FJ1200AD/AE	
FB-208 GASKET	82	XV920J VIRAGO
	83	XV920MK MIDNIGHT VIRAGO
	84-85	XV1000L/N VIRAGO
	86-87	XV1100S/T VIRAGO
FBG-209 ROUND 'O' RING	89-94	XT600
	91-93	XTZ660
	86-88	XT600Z
	87	XT600H/N
	90-98	XT600E
FBG-209P PRE-FORMED		SAME AS ABOVE
FBG-210 RUBBER 'O' RING	89-97	FZR600
	89-95	FZR1000
	90	FZR750R
	94-97	YZF750
	89-90	XTZ750
91	TDM850H/N	
FBG-211 RUBBER 'O' RING	87-88	FZR1000
FBG-212	86	XT350
	88	XT350 H<59Y>
	88	XT350 N<1WM>
	90-98	XT350

SUZUKI

FBG-301 RUBBER 'O' RING	85	GSX-R750F/G/XG
	86-88	DR200G/H/J
	90-93	DR250L/M/N/P
	90-97	DR350L/M/N/P/R/S/T/V
FBG-302 RUBBER 'O' RING	93-95	DR250SEP/SER/SES
	90-92	DR250SL/SM/SN
	94-95	DR350SER/SES
	90-93	DR350SL/SM/SN/SP
	93-95	DR650RP/RR/RS
	90-92	DR650SL/SM/SN
	91-93	GSF400M/N/P
	89-94	GS500EK/EL/EM/EN/EP/ER
	95-98	GS500ES/ET/EV/EW
	89-94	GSX750FK/FL/FM/FN/FP/FR
	95-97	GSX750FS/FT/FV
	88-92	GSX-R750J/K/L/M/N
	93-95	GSX-R750WP/WR/WS
	91-94	GSX1100GM/GN/GP/GR
	90-94	GSX600FL/FM/FN/FP/FR
	95-97	GSX600FS/FT/FV
	92-93	GSX-R600WN/WP
	93-98	GSX-R1100W P-W
	89-92	GSX-R1100K/L/M/N
93-95	GSX-R1100W P-S	
97-98	GSF1200SV/SW	
97-98	GSF1200SAV/SAW	
FBG-303 RUBBER O RING	88-89	GSX600FJ/FK
	88-92	GSX1100FJ/FK/FL/FM/FN
	86	GSX-R750RG
	86-87	GSX-R750G/H
	86-88	GSX-R1100G/H/J

KAWASAKI

FBG-401 GASKET	79	KZ650B3
	79	KZ650C3 CUSTOM
	79	KZ650D2
	80	KZ650E1 LTD
	80	KZ650F1
	79-80	KZ1000A3/A4 MKII
	79-80	KZ1000B3-B4 LTD
	79-81	KZ1000C2/C3/C4 POLICE
	80	KZ1000D3 Z1R
	79-80	KZ1000E1/E2 SHAFT ST
	FBG-402 RUBBER 'O' RING	90-93
93-97		ZX600E1-E5 NINJA ZX6
95-97		ZX600F1-F3 ZX6R
89-90		ZX750H1/H2 NINJA ZX7
91-92		ZX750J1/J2 ZX7
93-95		ZX750L1-L3
94-97		ZX900B1-B4 ZX9R
88-90		ZX1000B1-B3 ZX10
FBG-403 ROUND 'O' RING	90-93	ZX1100C1-C4 ZX11
	93-97	ZX1100D1-D5 ZX11
	96-97	ZX750P1-P2
	80-81	KZ250D1-D2 LTD & CSR
	82	KZ250L1 CSR
	83	KZ250W1 LTD
	81-82	KZ305A1-A2 CSR
	82	KZ305B1 CSR
	87-88	KZ305 B2-B3 LTD
	77-78	KZ400A1/A2
	78-79	KZ400B1/B2
	78	KZ400C1
	74-77	KZ400/D/D3/D4
	79	KZ400H1 LTD
	80-83	KZ440A1-A4
	80-81	KZ440B1/B2
	80-81	KZ440D1-D3 LTD BELT
	82-83	KZ440D4-D5
	82	KZ440G1 BELT
	84-85	ZN700A1-A2
	80-82	KZ750E1-E3
	80-83	KZ750H1-H4 LTD
83	KZ750F1 LTD SHAFT	
82-83	KZ750N1/N2 SPECTRE	

FBG-404 ROUND 'O' RING	88-89	EL250B2/B3 ELIMINATOR
	91-94	EL250E1-E4 ELIMINATOR
	86-87	EX250E1/E2 NINJA
	88-89	EX250F2-F4
	92-97	EX250F6-F11
	85-90	EN450A1-A6 LTD
	90-96	EN500A1-A7 VULCAN
	96-97	EN500C1/C2
	87-93	EX500A1-A7
	94-97	EX500D1-D4 NINJA
	90-93	ZR550B1-B4
	86-87	ZL600A1-A2 ELIMINATOR
	96-97	ZL600B2/B3 ELIMINATOR
	85-87	ZX600A1-A3 NINJA
	87	ZX600B1 NINJA
	88-97	ZX600C1-C10 NINJA
	91-93	ZR750C1-C3
	87-90	ZX750F1-F4
	85-86	ZL900A1/A2
	84-86	ZX900A1-A3 NINJA
	86-97	ZG1000A1-A12
	87	ZL1000A1 ELIMINATOR
	86-87	ZX1000A1/A2
	92-94	ZR1100A1-A3
	95-97	ZX1100E1-E3
	97	ZX1100F1 GPZ
	86-97	ZG1200A1/B1-B11 VOYAGER XI
	84	KL600A1 KLR
	85-86	KL600B1/B2 KLR
	87-98	KL650A1-A12 KLR
	90-91	KL650B1/B2 TENGAI
	93-96	KLX650A1-A4 OFF-ROAD
	93-96	KLX650C1-C4 DUAL SPORT
	96	KLX650D1

SUZUKI/KAWASAKI



FBG-901	77-79	GS550B/C/EC/N/EN
	79	GS550LN
	77-79	GS750B/C/EC/N/EN
	79	GS750LN
	79	GS850GN
	78-79	GS1000C/EC/N/EN
	79	GS1000LN
	79	GS1000SN
	77-78	KZ650B1/B2/B2A
	77-78	KZ650C1/C2 CUSTOM
	78	KZ650D1/D1A SR
	81	KZ650H1 CSR
	76-77	KZ900A4/A5
	76	KZ900B1 LTD
	77-78	KZ1000A1/A2
	77-78	KZ1000B1/B2 LTD
78	KZ1000C1-C1A POLICE	
78	KZ1000D1 Z1R	
FBG-902 GASKET		SUZUKI
	83	GS450ED
	83	GS450LD
	85-88	GS450LF/LG/LH/LJ
	83	GS450TXD
	80	GS550ET
	80-82	GS550LT/LX/LZ
	82	GS550MZ
	81	GS550TX
	83	GR650D/XD TEMPER
	81-82	GS650EX/EZ
	81-83	GS650GX/GZ/GD
	81-83	GS650GLX/GLZ/GLD
	83	GS650MD KATANA
	85	GS700EF/ESF
	80-82	GS750ET/EX/EZ
	83	GS750ED/ESD
80-81	GS750LT/LX	
82-83	GS750TZ/TD	
83	GS750SD KATANA	

FBG-902	80-83	GS850GT/GX/GZ/GD
	80-83	GS850GLT/GLX/GLZ/GLD
	80	GS1000ET
	80-81	GS1000GT/GX
	80-81	GS1000GLT/GLX
	80	GS1000ST
	82	GS1000SZ KATANA
	80-83	GS1100ET/EX/EZ/ED/ESD
	82-83	GS1100GZ/GD/GLZ/GLD
	82-84	GS1100GKZ/GK2/GKD/GKE
	80	GS1100LT
	83	GS1100SD
	83-85	GS1150ES3/ESE/EF/ESF
	85-86	GS1150EF2/EG/ESG
		KAWASAKI
	82-83	KZ650H2/H3 CSR
	84	KZ700A1
	83-84	KZ750K1/K2
	83	KZ750L3
	82	KZ750M1 CSR
	82	KZ750R1 GPZ
	83-85	ZX750A1-A3 GPZ
	81-83	KZ1000J1-J3
	81-82	KZ1000K1-K2 LTD
	81-82	KZ1000M1/M2 CSR
	82-83	KZ1000R1/R2 REPLICIA
	81-83	KZ1100A1-A3 SHAFT
	82-83	KZ1100D1/D2 SPECTRE
	83	KZ1100L1 LTD
	84-85	ZN1100B1/B2 LTD

FLOAT NEEDLE

Please note that different float needle might be used ,depending on market.
Check O.E.REF mentioned, and make sure that you are ordering correct item.

K1	HON	K1	VF1000F F/G 85-86
	CB125S	78-82	VF1000F2 F/G BOLD'O 85-86
	XL125S	79-85	VF1100C MAGNA 83-86
	CM185T	78-79	VF1100S SABRE 84-85
	CM200T	80-82	KAWA
	XL200S	78-81	EL250B2-B3 ELIMINAT(88-89
	XR200	80-84	EL250E1-E4 ELIMINAT(91-94
	XR200R	81-95	EX250E1/E2 86-87
	XL250R	84-87	EX250F2-F4 88-90
	XR250/R	79-82	EX250F6-F8 92-94
	XR250R	84-95	EX250F9-F11 95-97
	CB250T		KZ250D1-D2 LTD & CS 80-81
	CB250N/NA	79-80	KZ250L1 CSR 82
	XL350	77-78	KZ250WA LTD 83
	XL350R	84-85	EX305B1 GPZ 83
	XR350R	83-85	KZ305A1/A2 81-82
	CB400T		KZ305B1 CSR BELT 81-88
	CB400TII HAWK	78-79	KZ305B2/B3 LTD 87-88
	CM400A AUTOMATIC	79	KZ400A1/A2 DELUXE 77-78
	CM400TI HAWK	78-79	KZ400B1/B2 78-79
	CB400N/NA	79-80	KZ400C1 78
	CB400Nc	82	KZ400H1 LTD 79
	CX500	78-79	KZ400S 75-77
	CX500C CUSTOM	79	KZ440A1-A4 LTD 80-83
	CX500D DELUXE	78-79	KZ440B1/B2 80-81
	XL500S	79-81	KZ440D1-D5 LTD 80-83
	XR500/R	79-84	KZ440G1 BELT 82
	CB550K	77-78	EN450A1-A3 LTD 85-87
	XL600R	83-87	EN450A4-A6 LTD 88-90
	XR600R	85-86	EN500A1-A4 VULCAN 90-93
	CB650	79-80	EN500A5-A7 VULCAN 94-96
	CB650C CUSTOM	79-80	EN500C1/C2 VULCAN 96-97
	CB750A AUTOMATIC	76-78	EX500A1-A4 87-90
	CB750F SUPERSPORT	76-78	EX500A5-A7 91-93
	CB750F SUPERSPORT	79	EX500D1-D4 94-97
	CB750K	76-78	ZR550B1/B2 ZEPHYR 90-91
	CB750K	79	ZR550B3/B4 ZEPHYR 92-93
	CB750L LTD	79	ZL600A1/A2 ELIMINAT(86-87
	CB900FZ	79	ZL600B2/B3 ELIMINAT(96-97
	CB900FA(VB51A(A)	80	ZX600A1-A3 NINJA 85-87
	CBX Z	79-82	ZX600B1 87
	VF500C MAGNA	84-85	ZX600C1-C4 88-91
	VF500F INTERCEPTOR	84-85	ZX600C5-C8 92-95
	NT650 HAWK GT	88-91	ZX600C9-C10 96-98
	VF700F INTERCEPTOR	84-85	ZX600D1-D4 90-93
	VF700S SABRE	84-85	ZX600E1-E3 93-95
GL1200 GOLDWING	84	ZX600E4-E5 96-97	
GL1200A ASPENCADE	84	ZN700A LTD 84-85	
VT700C SHADOW	84-85	KZ750E1-E3 80-82	
VF750CC/CD/CE	82-84	KZ750F1 LTD SHAFT 83	
VF750C MAGNA	82-83	KZ750H1-H4 LTD 80-83	
VF750F INTERCEPTOR	83-84	KZ750N SPECTRE 82-83	
VF750FD/FE	83-84	ZR750C1-C3 ZEPHYR 91-93	
VF750S SABRE	82-83	ZX750F1-F4 87-90	
VF750SC	82	ZX750H1/H2 89-90	
VF750Sd	83	ZX750J1/J2 91-92	
VT750C SHADOW	83	ZX750L1-L3 93-95	
VT800C SHADOW	88	ZL900A1/A2 ELIMINAT(85-86	
VF1000F INTERCEPTOR	84	ZX900A1-A3 84-86	
VF1000FE INTERCEPTOR	84	ZG1000A CONCOURS 86	

K1	ZL1000A1 ELIMINATOR 87	M1	GS550N/EN/LN 79
	ZX1000A1-A3 86-87		GS750B/C/EC 77-78
	ZX1000B1-B3 ZX10 88-90		GS750N/EN/LN 79
	ZX1100C1-C4 ZX11 90-93		GS850GN 79
	ZX1100E1-E3 GPZ 95-97		GS1000C/EC/N 78-79
	ZG1200 VOYAGER XII 86-97		GS1000EN/LN/SN 79
VN1500 VULCAN 87-97	DT125LC 82		RD250LC 82
K2			RD350LC 82
			YAMA
	GL1000 GOLDWING 75-79		XS400D/E/2E/2F 77-79
	GL1000L LTD GOLDWING 76		XS400E 78
K3			XT500 76-79
	CM250C 82-83		XT500 88
	NX250 88-90		XS650 D/E/F 77-79
	XR250L 91-95		XS650 80
	CB250NDc 82		XS750D/2D 77
	CB400T HAWK 80-81		XS750E/SE/F/SF 78-79
	CM400A AUTOMATIC 80-81		XS1100E/SE/F/SF 78-79
	CM400C CUSTOM 81		XS360C/D/2D 76-77
	CM400E 80-81		M2
	CM400T 79-81		
	CB450SC NIGHHAWK 82-83		YAMA
	CB450SC NIGHTHAWK 85		XS400J MAXIM 82
	CB450T HAWK 82		XZ550RK VISION 83
	CM450A AUTOMATIC 82-83		XS400K MAXIM 83
	CM450C CUSTOM 82		XS400RJ SECA 82
	CM450E 82-83		XS400RK SECA 83
	CX500 A/B 80-81		XZ550RJ VISION 82
	CX500C A/B/C 80-83		XJ900RK SECA 83
	CX500C CUSTOM 80-82		SUZU
	CX500D DELUXE 80-82		GV1200GLF/GLG 86-86
	GL500 SILVERWING 81-82		GV1200GLF2 MADURA 85
	GL500I SILVER WING 81-82		GV700GLF MADURA 85
	CB550SC NIGHTHAWK 83		GV700GLF2 MADURA 85
	CB650 81-82		DR125SER/SES/SET 94-96
	CB650C CUSTOM 81-82		DR200SET/SEV 96-97
	CB650SC NIGHTHAWK 82		GS250TT/TX 80-81
	CB650SC NIGHTHAWK 83-85		GS300LZ/LD/LF 82-85
	CX650C CUSTOM 83		GS450ED 83
	GL650 SILVERWING 83		GS450GAZ-GAF 82-85
	GL650I SILVERWING 83		GS450LD 83
	CB700SC NIGHTHAWK 84-85		GS450LF/LG/LH/LJ 85-88
	CB750F SUKPERSPOR 80-82		GS450TXD 83
	CB750FA/FB/FC/F2C 80-81		GS550ET 80
	CB750K 80-82		GS550LT/LX/LZ 80-82
	CB750SC NIGHTHAWK 82-83		GS550MZ 82
	CB900C CUSTOM 80-82		GS550TX 81
	CB900F SUPERSPORT 81-82		GSX600FJ/FK KATANA 88-89
CB900FA/FB/FC/F2C 81-82		GR650D/XD TEMPTER 83	
CB1000C CUSTOM 83		GS650EX/EZ 81-82	
CB1100F SUPERSPORT 83		GS650GLX/GLZ/GLD 81-83	
CB1100R B/C/D 81-83		GS650GX/GZ/GD 81-83	
	KAWA	GS650MD KATANA 83	
	KZ1000A1/A2 77-78	GS700EF/ESF 85	
	KZ900A4-A5 76-77	GS750ED/ESD 83	
	KZ900B1 LTD 76	GS750ET/EX/EZ 80-82	
	KZ1000 D1 Z1R 78	GS750LT/LX 80-81	
	KZ1000A3-A4 MKII 79-80	GS750SD KATANA 83	
	KZ1000B1/B2 LTD 77-78	GS750TZ/TD 82-83	
	KZ1000B3/B4 LTD 79-80	GSX-R750G/H 86-87	
	KZ1000D3 Z1R 80	GSX-R750RG 86	
	KZ1000E1/E2 SHAFT S 79-80	GS850GLT/GLX/GLZ/C 80-83	
	SUZU	GS850GT/GX/GZ/GD 80-83	
	GS550B/C/EC 77-78	GS1000ET 80	
		GS1000ST 80	
		GS1000SZ KATANA 82	

M2	GS1100ET/EX/EZ/ED/180-83	
	GS1100GKZ/GK2/GKD.82-84	
	GS1100GZ/GLZ/GD/GI.82-83	
	GS1100LT	80
	GS1100SD KATANA	83
	GSX-R1100G/H/J	86-88
	GS1150EF2/EG/ESG	85-86
	GS1150ES3/ESE/EF/EI.83-85	
	KAWA	
	KZ700A1	84
	KZ750K1/K2	83-84
	KZ750M1 CSR 2CYL	82-83
	KZ750R1 GPZ	82
	ZX750A1-A3 GPZ	83-85
	KZ1000J1-J3	81-83
	KZ1000K1/K2	81-82
	KZ1000M1/M2 CSR	81-82
	KZ1000R1/R2 REPLICIA	82-83
	KZ1100A1-A3 SHAFT	81-83
	KZ1100D1/D2 SPECTRI	82-83
ZN1100B1/B2 LTD SHA	84-85	

M3 (HITACHI TYPE) 	YAMA	
	RD350 YPVS	83-85
	XJ650LH MIDNIGHT M/81	
	XJ650RJ SECA	82
	XS850G/H	80-81
	XS850LG/LH SPECIAL	80-81
	XS850SG/SH SPECIAL	80-81
	XV1000L/N VIRAGO	84-85
	XV1100S/SC/T/TC	86-87
	XJ650G/H/J/K MAXIM	80-83
	XJ700S/SC MAXIM	86
	XV700CS/CSC	86
	XV700CT/CTC	87
	XV700L/LC/N/NC	84-85
	XJ750J/K MAXIM	82-83
	XJ750MK MIDNIGHT M/83	
	XJ750RH/RJ/RK SECA	81-83
	XV750H/J/K VIRAGO	81-83
	XV750MK MIDIGHT VIR	83
	XV920J VIRAGO	82
	XV920K VIRAGO	83
	XV920MK VIRAGO	83
	XV920RH/RJ	81-82

M4 	SUZU	
	GSX-R750J/K/L/M/N	88-92
	GSX750FK/FL/FM/FN	89-92
	GS1100GM	91
	GSX-R1100K/L/M/N	89-92
	GSX-R1100WP/WR	93-94
	YAMA	
	FZR400A/SAC	90
	FZR400U/SUC/W/SWC	88-89
	FZ600S/SC/T/TCU/UC	86-88
	FZR600RA/RAC	90
	FZR600RB/RBC/RD/RI	91-92
	FZR600RE/REC/RF/RF	93-94
	FZR600RG/RGC/RH/RI	95-96
	FZR600RJ/RJC	97
	FZR600W/WC/AC	89-90
	XJ600SD/SDC/SE/SEC	92-93
	XJ600SF/SFC/SG/SGC	94-95
XJ600SH/SHC/SJ/SJC	96-97	
YX600S/SC/T/TC/U/U	86-88	

M4	YX600W/WC/A/AC RAI	89-90
	XS650G/HJ SPECIAL II	80-81
	FZX700S/SC/T/TC	86-87
	XJ700XN/XNC MASIM	85
	XJ700XS/XSC MASIM	86
	FZ750T/TC	87
	FZR750RT/RU	87-88
	XV750A/AC/B/BC VIR	90-91
	XV750D/DC/E/EC VIR	92-93
	XV750F/FC/G/GC VIR	94-95
	XV750U/UC/W/WC VIR	88-89
	TDM850D/DC/E/EC	92-93
	FZR1000T/TC/U/UC	87-88
	XJ1100L/LC/N/NC	84-85
	XV1100UC-J/JC	88-97
	FJ1200AD/ADC/AE/AE	92-93
	FJ1200B/BC/D/DC	91-92
	FJ1200S/SC/T/TC	86-87
	FJ1200W/WC/A/AC	89-90
	SR250G/H/J	80-82
	SR250TH EXCITER II	81
	XS400G/H SPECIAL II	80-81
	XS400SG/SH/SJ SPEC	80-82
	XJ550H/J/K MAXIM	81-83
	XJ550RH/RJ/RK SECA	81-83
	FJ600L/LC/N/NC	84-85
	XS650SG/SH SPECIAL	80-81
	XS650SJ/SK HERITAGE	82-83
XJ1100J MAXIM	82	
XS1100G/H	80-81	
XS1100LG/LH	80-81	
XS1100SG/SH	80-81	

M6 	YAMA	
	SR500E/F/G/H	78-81
	XT500E/F/G/H	78-81

Y14F 	YAMA	
	XT600A/AC/B/BC	90-91
	XT600D/DC/E/EC	92-93
	XT600F/FC/G/GC	94-95

AIR CUT OFF VALVES

To prevent "after-burn" generated by a lean fuel mixture when closing the throttle, the air cut-off valve temporarily closes the slow-jet air passage and creates an instantly richer mixture.



HONDA

ACV-101	16048-429-771	diaphragm 1 spring 1 o ring 1
	XL250S	80-81
	XL250R	80-82
	CB400T	80-81
	CB400F	80-81
	CM400T	80-81
	CM400A	80-81
	CM400C	81
	CM400E	80-81
	CM400T	80-81
	CB450SC NIGHTHAWK	82-86
	CB400T HAWK	82
	CM450E	82-83
	CX500 CUSTOM	80-82
	CX500D	80-82
	GL500	81-82
	XL500S	79-81
	XR500	79-80
	XR500R	81-82
	CB650	80
	CB650 CUSTOM	80
	CB750C CUSTOM	80-82
	CB750K	80-82
CB750F SUPERSPORT	80-82	
CB750SC	82-83	
CB900F	81-82	
CB750FA/FB/FC/F2C/FD/F2D	80-83	
CB900FZ/FA/FB	79-81	
CB900FC/F2C/FD/F2D	82-83	
GL1100/A/I	80-83	
ACV-102	16048-KB7-004	diaphragm 1 spring 1 o ring 1
	XL250R	82-83
	XR250R	86-91
	XR350R	85
	XL500R	82
	XR600R	88-91
	CX650 CUSTOM	83
	CX650	76-79
	GL650	83
	CB1100F/FD	83
	CB1000 CUSTOM	83
ACV-103	16048-425-671	diaphragm 1 spring 1 o ring 1
	CB750K/L/F	79
	CB650	79
	CB750FZ	79
ACV-104	16048-413-004	diaphragm 1 spring 1 o ring 1
	XL250S	78-79
	CB400A	78
	CB400T HAWK	78-79
	CM400A	79
	CM400T	79
	CB400N/NA	80-81
	CX500	78-79
	CX500C CUSTOM	79
	CX500D	79
ACV-105	16048-371-004	diaphragm 1 spring 1 o ring 3
	GL1000/K1/K2/K3	75-79
	GL1000 LTD	76
ACV-106	16048-MG9-741	diaphragm 1 spring 1 o ring 1
	GL1200A ASPENCADE	86-87
	GL1200I INTERSTATE	86-87

ACV-107	16048-MA2-004	diaphragm 1 spring 1 o ring 1
	CBX1000	79-82
ACV-108	for 2 Carb.	diaphragm 2 spring 4 o ring 2
	* O.E.REF : 16048-MM8-014 16048-MAH-670 16048-MM8-772	
	VT1100C SHADOW	87-96
	VT1100G2 SHADOW AMERICAN CLASSIC EDITION	96-96
ACV-109	for 2 carb.	diaphragm 2 spring 4 o ring 2
	* O.E.REF : 16048-MR1-004 16048-MR1-305 16048-MS9-000	
	VT600C SHADOW	89-96
	VT600CD SHADOW	93-94
	PC800 PACIFIC COAST	89-90
	PC800 PACIFIC COAST	94-96
NT650 HAWK GT	88-91	
ACV-110	for 1 Carb.	diaphragm 1 spring 1 o ring 1
	* O.E.REF : 16048-MR7-004 16048-MM5-671	
	ST1100L/M/N/P/R ST1100AN/AP/AR	90-94 92-94

YAMAHA

ACV-201	3LD-1490H-00 (26H-1490H-00)	diaphragm 1 spring 1
	XT225E/EC/F/FC	93-94
	XT225G/GC/H/HC	95-96
	TDM850D/DC/E/EC	92-93
	XVZ12TK VENTURE	83
	XVZ12TDK VENTURE ROYALE	83
	XVZ12DL/DKC2 VENTURE ROYALE	84
	XVZ12DN VENTURE ROYALE	85
	XVZ13DS/DT VENTURE ROYALE	86-87
	XVZ13DSC/DTC VENTURE ROYALE	86-87
	XVZ12T/TC/U/UC VENTURE	87-88
	XVZ13DU/DUC VENTURE ROYALE	88
	XVZ13DW/DWC VENTURE ROYALE	89
	XVZ13DA/DAC VENTURE ROYALE	90
	XVZ13DB/DBC VENTURE ROYALE	91
	XVZ13DD/DDC VENTURE ROYALE	92
	XVZ13DE/DEC VENTURE ROYALE	93
	VMX12N/NC/S/SC V-MAX	85-86
	VMX12U/UC/W/WC/A/AC V-MAX	88-90
	VMX12B/BC/D/DC/E/EC V-MAX	91-92
	VMX12F/FC/G/GC V-MAX	94-95
	VMX12H/HC V-MAX	96
	<ATV>	
YFM350ERT/ERU/ERW/ERA MOTO4	87-90	
YFM350ERD/ERE/ERF/ERG MOTO4	92-95	
YFM350FWT/FWU/FWW BIG BEAR	87-89	
YFM350FWA/FWB/FWD BIG BEAR	90-92	
YFM350FWE/FWF/FWG BIG BEAR	93-95	
YFM350XT/XU/XW/XA WARRIOR	87-90	
YFM350XB/XD/XE/XF/XG	91-95	
YFP350U TERRAPRO	88	
YFM400FWE/FWF/FWG KODIAK	93-95	
ACV-202	22U-1490H-00	diaphragm 1 spring 1
	XV500K VIRAGO	83
	XV535T/TC/U/UC	87-88
	XV535A/AC VIRAGO	90
	XV535E/EC/F/FC/G/GC VIRAGO	93-95
	XV535SF/SFC/SG/SGC VIRAGO	94-95

AIR CUT OFF VALVES

ACV-203	3CF-1490H-00	diaphragm 1
		spring 2
	XV750W/WC/A/AC/B/BC VIRAGO	89-91
	XV750D/DC/E/EC/F/FC VIRAGO	92-94
	XV750G/GC/H/HC VIRAGO	95-96
	XV750H1/HC1 VIRAGO	96
	XV1100U/UC/W/WC/A/AC/B/BC	88-91
	XV1100D/DC/E/EC/F/FC/G/GC	92-95
ACV-204	22V-14940-00	diaphragm 1
	4NK-14935-00	spring 1
ACV-205	XVZAH/AHC/ATH/ATHC ROYAL STAR	96
	1JK-1490A-00	
	XT600Z	86
	XT600Z	88
	XT600 H/N	87
	XT600E H <3TB1-9>	90-94
	XT600E N <3UW2-4>	91-93
	XT600E <4ME1/4PT1-9, 4SK1>	94-98
	TT600 <5CH2>	99
	XTZ660 H/N	92-93
	ACV-206	5Y1-1490A-00
XT600Z		84
TT600		83-86
XT350 H/N <59Y/1WM>		88
XT350		86
XT350		94
XT350		97-98

SUZUKI

ACV-301	13480-05A10	diaphragm 1
	13481-05A10	spring 1
	* 4 kits required per model	
	GV700GLF/GLF2 MADURA	85
	GV1200GLF/GLF2/GLG MADURA	85-86
	GV1400GCG/GCH CAVALACADE LX	86-87
	GV1400GDG/GDH CAVALACADE LX	86-87
	GV1400GDJ/GDK CAVALACADE LX	88-89
ACV-302	13480-05A10	diaphragm 1
	13481-05A10	spring 1
	* 2 kits required per model	
	VS700GLFG/GLFH INTRUDER	86-87
	VS700GLPG/GLPH INTRUDER	86-87
	VS700GLEFG/GLEFH INTRUDER	86-87
ACV-303	13480-05A10	diaphragm 2
	13481-45C10 front	spring 1
	13481-05A10 rear	spring 1
	VS800GLN/GLR	92-94
	VS800GLS	95
ACV-304	13480-05A10	diaphragm 2
	13481-45C10 front	spring 1
	13481-45C10 rear	spring 1
	VX800L/M/N/P	90-93
	VS800GLS	95
ACV-305	13480-05A10	diaphragm 1
	13481-24B00	spring 1
	LS650FPG/FPJ/FPJ SAVAGE	86-88
	LS650FFG/FFH SAVAGE	86-87
ACV-306	13480-05A10	diaphragm 2
	13481-38B00 front	spring 1
	13481-38B00 rear	spring 1
	VS1400GLPH/GLPJ INTRUDER	87-88
	VS1400GLFH INTRUDER	87
ACV-307	13480-05A10	diaphragm 2
	13481-38B40 front	spring 1
	13481-38B40 rear	spring 1
	VS1400GLPL/GLPM/GLPN INTRUDER	90-92
	VS1400GLPP/GLPR/GLPS INTRUDER	93-95

KAWASAKI

ACV-401	43028-1053	diaphragm 1
	92081-1891	spring 1
	92055-1245	o ring 1
	EL250B2/B3 ELIMINATOR	88-89
	EL250E1 ELIMINATOR	91
	EX250E1/E2	86-87
	EX250F1/F2/F3	88-90
	EX250F6/F7/F8/F9	92-95
	KL600A1/B1/B2 KLR600	84-86
	KL650A1-A9 KLR650	87-96
	KL650B2 TENGAI	90
	KLX650A1-A3	93-96
	KLX650C1-C3	93-96
	VN700A1 VULCAN	85
	VN750 A2-A11 VULCAN	86-96
	ZG1000A1-A8 CONCOURSE	86-94
	ZL1000A1	
VN1500A1-A10 VULCAN 88	87-96	
VN1500B1-B5 VULCAN 88SE	87-91	
VN1500G1L/L		
VN1500S2/A2L		
ACV-402	43028-1013	diaphragm 1
	92081-1156	spring 1
	92055-1245	o ring 1
	KZ1300A1-A4	79-82

CARB. PUMP DIAPHRAGM VALVE SET

CONSIST OF:

- DIAPHRAGM 1
- BELLOW RUBBER 1
- SPRING 1
- (O RING 1 PCS FOR CDV-102 and CDV-104)



CDV-101
16021-393-004
16021-393-014
16021-MC9-771
CB450SC'83
CM450E'83
CB750K'77-78
CB750F'77-78
CB750A'76-78

CDV-102
16021-413-751
16021-438-671
16021-463-004
CM250C'83
CM400E'80-81
CM400A'80-81
CM400C'81
CM400T'80-81
CB400T'80-81
CM450E'82
CM450C'82
CB450T'82
CB450SC'82
CX500C'80-82
CX500D'80-81
GL500/I'81-82
CB900F'81-82
GL1100/I'80-82
GL1100A'82
GL1100/I/A'83

CDV-103
16021-679-005
CB750F'79
CB750L'79
CB750K'79-82
CB750C'80-82
CB750CA'80
CB750SC'82-83
CB900C'80-82

CDV-104
16021-ME2-671
16021-MG1-671
CX650C'83
GL650/I'83
CB1000C'83
CB1100F'83

CDV-105
16021-422-004
CBX1000'79-82

CDV-106
16021-MT8-000
16021-MW8-000
GL1500'88-90
GL1500A'91
GL1500I'91
GL1500SE'91
GL1500A'92-99
GL1500I'92-99
GL1500SE'92-99

VACUUM VALVE



*Model application is different ,depending on market.
Please check part number mentioned before ordering.

for KAWASAKI

VCC-403	KZ1000 J1/J2/J3'81-83
	Z1000 J1/J2'81-82
	KZ1000 R1 REPLICA '82
	KZ1000 P1'82
	KZ1000 M1/M2 CSR'81-82
	KZ1000 LTD K1/K2'81-82
	KZ1100 A1/A2/A3 '81-83
KZ1100 D1/D2'82-83	

VCC-314	GSX-R400 L/M/N/P/S <GK76A>
	GS500E '97-00
	GSX600F V'97
	GSX-R600V'97-00
	GSX750F V'97-00
	RF600R(U) R/S/T'94-96
VCC-317	RF900R R/S/ZS/T/V'94-97
	GSX-R1100W P-W'93-98
	GSF1200S/SA '96-02
	SV650(U/SU)X/Y'99-00
	GSX-R750 T/V'96-97

for SUZUKI

VCC-301	GS500E K/L/M'89-91
	GS500E(U)K/L/M'89-91
	GS500E R/S/T'94-96
	GS500E(U)R/S/T'94-96
	GSX600F L/M/N/P/R/S'90-95
	GSX600FU L/M'90-91
	GSX-R600W N/P'92-93
	GSX750F K/L/M/N/P/R/S/T'89-96
	GSX-R750 J/K/L'88-90
	GSX1100G M/N/P'91-94
	GSX-R1100 K/L'89-90
	GSF1200'96
VCC-302	GSF1200S T'96
	GS500E N/P'92-93
	GS500E(U) N/P<E1,E18,E22,E39>'92-93
	GSX600FU N/P/R/S'92-95
	DR250S L/M'90-91
	DR250S N/P/R'92-94 (E21/24)
VCC-303	DR250SE S'95
	DR350S L/M/N/P/R'90-94
	DR350SE R/S/V/W'94-98
	GSX-R750 L/M'90-91
VCC-305	GSX-R750W N/P/R/S'92-95
	GSX-R1100 M/N'89-92
	GSX-R1100W P/R/S/T'93-96
	DR650SE(U)T/V/W/X/Y'96-00
VCC-306	GSX-R1100 G/H/J'86-88
	VS1400GL(P/F) K/L/M/N/P/R'89-94 (REAR)
VCC-308	VS1400GL(P/F)K/L/M/N/P/R'89-94(FRONT,E22/24)
VCC-311	GS650G X/Z'81-82
	GS750E T/X/Z'80-82
	GSX750E T/X/Z'80-82
	GS750L T/X'80-81
	GS750T D/Z'82-83
	GS850G T/X'80-81
	GS850GL T/X'80-81
VCC-313	GS450E/EU J'88
	GS450S/SU J'88
	GS450L F/G/H'85-87
	GS1000E T'80
	GS1000H T'80
	GS1000G T/X'80-81
	GS1000GL X'81
	GS1100G E/G'84-86
GSX1100L T'80	

for YAMAHA

VCC-201	XTZ750,H '89-93<3LD>
	XTZ750'94-96<3LD>
	XTZ750,N'90-93<3WM>
	YZR750RH/RHC'96<4LE>
	TDM850H'91-93<3VD>
	TDM850'94-95<3VD>
	TDM850N'91-93<4CM>
	TDM850'97-98<4TX>
	TRX850'96<4UN>
	FZR1000'89-91<3LE>
VCC-204	FZR1000'92-95<3LE>
	XJ600S DIVERSION'92-95<4EB,4LX>
VCC-206	XJ600SN DIVERSION'92-95<4DS>
	XJ600N'94-95<4KA,4MB>
	XV750'92-94<4FY>
VCC-210	XV1100'89-95<3LP>
	XV750SE VIRAGO'92-94
	XS650SJ/SK HERITAGE'82-83<5V4>
	XS650SG/SH'80-81<4M4>
VCC-211	XS650 G/H SPECIAL II'80-81<3GO>
	XJ900'83-90<31A,42N,58L,1FW,2HL,3NG>
	XJ900RK SECA'83
	XS1100G/H'80-81<3H5,4R1>
	XS1100LG/LH'80-81<4H3,4W1>
	XS1100SG/SH'80-81<3J6,4RO>
	XJ1100J MAXIM'82
VCC-212	FZR600H'89-93<3HE>
	FZR600M'89-93<2RG>
	FZR600RH/RHC'96<3HH,3UU>
VCC-221	FZR600RK/RKS'98<3HH,3UU>
	XJ550R H/J/K SECA'81-83<4U8>
VCC-222	XJ550'81-83<27A>
	XS650'80-81<1U3>
	FJ1100N'85<50H>
VCC-223	FJ1200'88-92<3YA>
	FJ1200S/SC/T/TC'86-87<1UX>
	FJ1200W/WC/A/AC/B/BC/D/DC'89-92
	<3SK,4AH>
VCC-223	FJ1200AD/ADC/AE/AEC'92-93<4AH>
	XS400SE'82<4G5>
	XS400G'80<3F8>
	XS400H'81<4R5>
	XS400SH/SJ'81-82<4R4,14V>
XS400J'82<12R>	
XS400K'83 MAXIM<12R>	

VCC-224	FZR1000'87<2LA>
VCC-225	FZ750'88
VCC-226	FZ400N<1KF>'85 FZR400R<46X/2EL/3CD>'84-87
VCC-227	FZR400<1WG/2TK>'86-87
VCC-228	FZR400<3EN/3EN2>'88-89
VCC-230	FJ1100'84-85<47E>
VCC-232	XJ600S'96 <37kw 4EB> XJ600N'97-99<4KA4/5/6> XJ600S'97-99<4EB7/8/9>
VCC-233	XJR1200'95-98<4PU> XJR1200SP'98<4PU>
VCC-234	XJ900S'95-01<4KM> XJ900S/SP'02 <4KMD/E,4PS8>
VCC-235	YZF1000R'96-01 YZF-R1'98-99<4XV> TDM850'99 XV1600A'00
VCC-236	XVS650'97<4VR> XVS650'98-01<4VR5/6/9/A/B/D> XVS650A<5BN8/A> XVS650'02 <5SC5>
VCC-238	XT600Z'86 XT600H/N '87 XT600Z '88 XT600E <3TB1/3/7/9>'90-94 XT600E <3UW2/3/4>'91-93 XT600E <4ME1>'94 XT600E <4PT1/3/5/9>'95-98 XT600E <4SK1>'95
VCC-239	TT600'99
VCC-240	YP250 <4UC1/2>'96-97 YP250 <4UD2>'97 YP250DE <5DF1/2>'98 YP250A <5DF3/5DF4>'99 YP250D <5DF5/5DF6>'99
VCC-241	XTZ660 H/N'92-93

remarks:

VCC-402,312 are no longer available
VCC-207/209 are no longer available
VCC-230 BECOME AVAILABLE

VCC-201



VCC-206



VCC-210



VCC-211



VCC-224



VCC-233



VCC-301



VCC-303



VCC-313



VCC-403



VCC-222



VCC-223



VCC-238



VCC-240



VCC-305



VCC-311



VCC-403



CARB HOLDERS

Please check O. E. Ref before ordering.
Different parts might be used
in your market.



STOCK NR	MODELS	YR	MARKET / CODE
	KAWASAKI		
CHK-1	KZ1000 A1-A4	77-80	
	KZ1000 B1-B4 LTD	77-80	
	KZ1000 C2-C4	79-81	
	KZ1000 D1 Z1R	78	
	KZ1000 D3 Z1R	80	
	KZ1000 E1-E2 SHAFT	79-80	
	KZ900 A4	76	
	KZ900 LTD	76	
	Z1 /A/B 900	73-75	
CHK-3	KZ650 H2-H3	82-83	
	KZ700 A1	84	
	KZ750 E1-E3	80-82	
	KZ750 F1	83	
	KZ750 H1-H4	80-83	
	KZ750 L1-L3	81-83	
	KZ750 N1/N2	82-83	
	KZ750 R1 GPZ	82	
	ZN700 A1-A2	84-85	
	ZX750 A1-A3 GPZ	83-85	
	ZX750 E1-E2 TURBO	84-85	
CHK-4	ZX1000 A1/A2	86-87	
CHK-4/2	ER500 A1-A3	97-99	
	ER500 D1	01	
	EX500 A1-A7	87-93	
	EX500 B1-B4	88-91	
	EX500 D1-D5	94-98	
	EX500 D6-D7	99-00	
	EX500 E9	02	
CHK-6	ZX600 A1-A4	85-87	
	ZX600 B1 ' 87	87	
	ZX600 C1-C10	88-97	
CHK-7	KZ1000 A3	83	
	KZ1000 J3	83	
	KZ1000 R2	83	
	KZ1100 D2	83	
	KZ1100 L1	83	
	ZN1100 B1-B2 LTD	83-85	
	ZX1100 A1-A2	83-84	
CHK-8	KZ1000 J1/J2		
	KZ1000 K1/K2 LTD	81-82	
	KZ1000 M1/M2 CSR	81-82	
	KZ1000 R1 REPLICIA	82	
	KZ1100 A1/A2	81-82	
	KZ1100 B2	82	
CHK-9	ZX900 A1/A3	84-86	
CHK-10B	ZX1000 B1-B3 ZX10	88-90	
CHK-11B	ZX1100 C1-C4	90-93	
	ZX1100 D1-D6	93-98	
CHK-12	ZX600 D1-D4	90-93	
CHK-13B	ZX600 E1-E6	94-98	
	ZX600 E7-E10	99-02	
CHK-14B	ZX600 F1/F2/F3	95-97	
CHK-15	ZX900 C1/C2	98-99	
	ZX900 E1/E2	00-01	
CHK-16	ZR1100 C1-C4	97-00	
	ZR1100 D1-D3	97-99	
	ZR1100 D4	00	
	ZR1200 A1-A3	01-03	
	ZR1200 B1-B3	01-03	
	ZR1200 C1-C2	01-03	
CHK-17	ZX600 G1/G2	98-99	
	ZX600 J1/J2	00-01	
	ZX636 A1	02	
CHK-18	EJ650 A1-A4	99-02	
	YAMAHA		
CHY-1	XS400 2E/2F	78-79	2G5, 2V6
	XS400 D/E/F/G/H	77-81	2A2, 2L0, 3F8, 4R5
	XS400S G/H/J	80-81	3FG, 4R4
	XS400SH	81	4G8
CHY-2	XS650 G/H SPECIAL II	80-81	
	XS650 SG/SH SPECIAL	80-81	
	XS650 SG/SK HERITAGE SPECIAL	82-83	
CHY-3	XS750 F	79	
	XS750S E/F	78-79	
	XS750SE	80	
	XS850 G/H	80-81	3J3, 4R3
	XS850L G/H	80-81	4H1, 4WD
	XS850S G/H	80-81	3J2
CHY-4	XJ550	83	27A
	XJ550	81	4V9
	XJ550 H/J/K MAXIM	81-83	5K5
	XJ550R H/J/K SECA	81-83	4U8

STOCK NR	MODELS	YR	MARKET / CODE
CHY-5	XJ1100 J	82	
	XS1100	88	3X0
	XS1100 E/F/G/H	78-81	3H5, 4R1
	XS1100S G/H ' 80-81	80-81	3J6, 4R0
CHY-6	XV750 H/J/K VIRAGO	81-83	4X7
	XV750M K MIDNIGHT VIRAGO	83	
	XV920 J/K VIRAGO	82-83	
	XV920R H/J	81-82	
CHY-7	XV1000 L/LC/N/NC VIRAGO	83-85	56V, 56W
	XV1000SE	83	23W
	XV1100 VIRAGO	86-88	
	XV700 VIRAGO	84-87	
	XV920M K VIRAGO	83	
CHY-8	XVZ12/XVZ13 VENTURE & ROYAL	83-93	
CHY-9	FZ750 N/S/SC	85-86	
	FZ750' 88	88	3DY
	FZR750R T/U	87-88	
	FZX750 S/SL/T/TC	86-87	
CHY-10	SR500 E/F/G/H	78-81	
	XT500 E/F/G/H	78-81	
CHY-11	SR500	88	3EB
	SR500	82-84	
	XT500	88	
CHY-12	FJ1100L/LC/N/NC	84-85	50H, 47M
	FJ1200 AD/ADC-AE/AEC	92-93	4CR
	FJ1200 S/SC/T/TC	86-87	1UX, 1WJ
	FJ1200 U/UC-D/DC	89-92	3CSK, 4AH
CHY-15	YX600 S-WC RADIAN	86-90	
CHY-16	FZ600 S/SC/U/UC	86-88	
CHY-17	XV750 VIRAGO	92-93	4FY
	XV750 A/AC/B/BC VIRAGO	90-91	3JL
	XV750 H1/HC1/J1/JC1 VIRAGO	96-97	
	XV750 U/UC/W/WC VIRAGO	88-89	3AL, 3CM, 3JL
	XV750 VIRAGO	94-95	4FY, 4PW
CHY-19	XV1100	89-94	3LP
	XV1100 A/AC/B/BC	90-91	3JK
	XV1100 D/DC/E/EC	92-93	3JK
	XV1100 F/FC/G/GC	94-95	3JK
	XV1100 H/HG/J/JC	96-97	3JK
	XV1100 SH/SHC/SJ/SJC	96-97	
	XV1100 U/UC/W/WC VIRAGO	88-89	3CF, 3CG, 3JK
CHY-22	FZR1000 T/TC/U/UC	87-88	2LA
CHY-23	FZR1000 W/A/B/D/E/F/G	89-95	3LK
CHY-24	FZR1000	89-95	3LE1-3LE7
CHY-25	XJ900	83-85	31A, 42N, 1FW
CHY-26	SZR660	96-97	
	XTZ660H	92-93	<35.3KW>
	XTZ660 TENERE	91-93	
CHY-27	TX650	74	
	XS650	80	1U3
	XS650 B/C	75-76	
	XS650 D	77	
CHY-28	XT600 L/LC/N/NC	84-85	49N, 49R
	XT600 S/SC/T/TC	86-87	49N, 1WN
	XT600 U/UC/W/WC	88-89	3EW
CHY-29	XT600E	90-95	
	XT600E	99-02	
	XT600H	87	
	XT600Z	86, 88, 90	
CHY-32	XV125	97-99	
CHY-34	YP250	96	4UC
	YP250D	98	5DF
CHY-37	FZR600R	94-95	4JH
	YZF600R	96-02	4TV
CHY-38	XJ600S	92-93	4EB <37KW>
CHY-39	XJ600N	98	4KA, 4MB
carb. side	XJ600S	96-98	4EB, 4LX
CHY-40	XVS650	97-99	4VR, 4XR
	XVS650A	98-99	5BN
CHY-42	TDM850	94-95	3VD
	TDM850	96-98	4TX
	TDM850H	91-93	3VD <57KW>
CHY-44	YZF-R1	98-01	
CHY-45	FZS600	98-02	5DM1/2/4/5/7/9 5DMF/H, 5RT1
CHY-46	FZR600	91-93	3HE7/A/C<67KW>
CHY-47	RD250LC	82	
	RD350LC	82	
CHY-48	RD350	85	
	RD350LCF	88	

STOCK NR	MODELS	YR	MARKET / CODE
CHY-49	YFZ-R6	99-02	
CHY-50	XVZ1300 ROYAL STAR	96-00	
	XVZ1300A	96-97	
	XVZ1300AT	96-00	
	XVZ1300LT	99-02	
	XVZ13A	97-00	
	XVZ13AT	96, 99-00	
	XVZ13LT	97-01	
CHY-51	XT660X	04-08	
	XT660R	04-08	
	XT660Z TENERE	08	
	MT-03	06-08	
	HONDA		
CHH-1	CB750FZ/FA/FB/FC/F2G	79-82	
CHH-2	VFR750F L/M	90-91	E/ED/FI/G/IT/ND/SP
	VFR750F N	92	E/ED/F/G/IT/SP
	VFR750F P	93	E/ED/F/IT/SP
CHH-4	CBR1000F H	87	E/ED/FI/ND/SP
	CBR1000F J	88	E/ED/FI/IT/N/SP
	CBR1000F K/L	89-90	E/ED/FI/IT/N/SP/SW
	CBR1000F M	91	E/ED/FI/IT/SP/SW
	CBR1000F N	92	E/ED/IT/N/SP/SW
CHH-6	CBR600F M/N	91-92	E/ED/F/G/SP/SW
	CBR600F P/R	93-94	E/ED/F/SP/SW
CHH-8	CBR600F 1-4	01-04	E/ED/F/G
	CBR600F 5	05	E/ED
	CBR600FR	01-02	E/ED/F/G
	CBR600FS	01-02	E/ED/F/G
CHH-9	CBR900RR	00-03	E/ED/G
CHH-10	CB600F W HORNET	98	E/ED/F/G/H/SW
	CB600F X/Y/1/2 HORNET	99-02	E/ED/F/H/SW
	CB600F 3-4 HORNET	03-04	E/ED/F/H
	CB600F2 Y-2	00-02	E/ED/F/H/SW
CHH-11	ST1100 L-M	90-91	E/ED/F/FI/G/IT/N/ND/SP
	ST1100 N-R	92-94	E/ED/F/FI/ND/SP
	ST1100 S/T	95-96	E/ED/F/SP/SW
	ST1100 V-Y	97-00	E/ED/F/IT/SP/SW
	ST1100A N	92	E/ED/F/G/IT/SP/SW
	ST1100A P	93	E/ED/F/ND/SP/SW
	ST1100A R	94	E/ED/F/IT/SP
	ST1100A S-Y	95-00	E/ED/F/IT/SP/SW
	ST1100P P	93	E/ED/SP
	ST1100P S	95	E/ED
	ST1100P T/Y	96/00	E/ED/SP
CHH-12	VF750C P-X	93-99	E/ED/F/G/SP/SW
	VFR750F R/S	94-95	E/ED/F/IT/SP/SW
	VFR750F T	96	E/ED/F/IT/SP
	VFR750F V	97	E/ED/F/H/W
CHH-14	VFR750R J	88	E/ED/F/FI/IT/N/SP/SW
	VFR750R K	89	E/ED/F/IT/SP/SW
	VFR750R L	90	E
CHH-15	VFR800F1 W-X	98-99	E/ED/F/G/ND/SW
	VFR800 Y-1	00-01	E/ED/F
CHH-16	VFR800	02-05	E/ED/F
	VFR800A	02-05	E/ED/F
CHH-18	VT600C J	88	ED/F/G/SD
	VT600C K	89	ED/F/G/IT/SD
	VT600C L	90	ED/F/G/IT/N/SD/SP
	VT600C M	91	F I/N
	VT600C N-P	92-93	E/ED/F/FI/G/IT/SP
	VT600C R	94	E/ED/F/G/IT/SP
	VT600C S	95	E/ED/F/FI/G/IT/SP
	VT600C T	96	E/ED/F/G/SP
	VT600C V	97	E/ED/F/FI/G/SP
	VT750C V	97	E/ED/F/G/IT/SP/SW
	VT750C W-Y	98-00	E/ED/F/SW
	VT750C	01-02	E/ED/F/H
	NTV600 J-M	88-90	E
	XL600V J	88	E/FI/G/IT/ND/SP
	XL600V K	89	E/F/G/IT/ND/SP
	XL600V L	90	F/IT/SP
	XL600V M-R	91-94	E/F/G/IT/SP
	XL600V T	96	E/F/G/IT/SP
	XL600V V-X	97-99	E/F/G/IT/SW
	XL650V Y-5	00-05	E/ED/F
	XRV650 J-K	88-89	F/FI/IT/SP

E ENGLAND
ED EUROPEAN DIRECT SALES
F FRANCE
G GERMANY
ND NORTH EUROPE
SW SWITZERLAND
N NORWAY
SP SPAIN
IT ITALY
H HOLLAND
SD SWEEDEN

STOCK NR	MODELS	YR	MARKET / CODE
CHH-19	NT650V W-1	98-01	E/ED/F/G
	NT650V	02-05	E/ED/F
	NTV650 J-K	88-89	ED/F/FI/G/IT/SP
	NTV650 M	91	ED/F/G/SP
	NTV650 P	93	E/ED/F/G/SP
	NTV650 S	95	E/ED/F/G
	NTV650 T-V	96-97	E/ED/F/G/SP
	XRV750 L-N	90-92	E/F/G/H/IT/ND/SP
CHH-20	VT1100C2 S-V	95-97	ED/F/G/SP
	VT1100C2 W	98	ED/F/G/FI/SP
	VT1100C2 X	99	ED/F/G/FI
	VT1100C2	02	ED/F
CHH-21	CB500 R	94	E/F/G/IT/SP/SW
	CB500 T-V	96-97	E/F/G/IT/ND/SP/SW
	CB500 W-Y	98-00	E/F/G/IT/ND/SW
	CB500	02	E/F/G/ND/SW
	CB500S W-Y	98-00	E/F/G/IT/ND/SW
	CB500S	02	E/F/G/ND/SW
CHH-23	GL1500A M	91	N/SD/SP
	GL1500A N	92	F/N/SD/SP
	GL1500A P	93	ED/F/FI/SD
	GL1500A R-V	94-97	ED/F/FI/SD/SP
	GL1500 J-L	88-90	E/ED/F/FI/G/IT/N/SP
	GL1500SE M-N	91-92	E/F/FI/IT/SW
	GL1500SE P-W	93-98	E/ED/F/FI/G/SP/SW
	GL1500SE X-Y	99-00	E/ED/F/FI/G/SD/SP
CHH-24	XL1000V X-2	99-02	E/ED/F
CHH-25	VTR1000F V-2	97-02	G
	VTR1000F	03	E/ED/F
	VTR1000F	05	E/ED/EK
CHH-26	VTR1000F V	97	E/ED/F/IT/ND/SW
	VTR1000F W-Y	98-00	E/ED/F/FI/IT/ND/SW
	VTR1000F 1-3	01-03	E/ED/F
CHH-27	CBR1000F K-N	89-92	F/G/SD
CHH-28	CBR600F H/J	87-88	E/ED/F/G/IT/N/SD/SP
CHH-29	CBR600F K/L	89-90	E/ED/F/G/IT/N/SD/SP
CHH-30	CBR600F X-Y	99-00	E/ED/F/SW
CHH-31	CBR900RR W	98	E/ED/ND
	CBR900RR X	99	E/ED/G/ND/SD
CHH-32	CBF600N/NA/S	04-06	ED (25K) 34 PS
CHH-33	CBF600N/NA/S	04-06	E/ED/F
CHH-34	VT125C	99-00	E/ED/F/G/SW
	VT125C	01-03	E/ED/F/SW
	VT125C	04-06	E/ED/F
	XL125V	01-02	E/ED/F/G
	XL125V	03	E/ED/F
	XL125V	04-06	E/EU
CHH-35	CBR600RR	03-06	E/ED/G/U
CHH-36	CB900F	02-05	E/ED/F/H/U
CHH-37	CBR1000RR	04-05	E/ED/G/U
CHH-38	XL1000V	03-06	E/ED/F/G
	XL1000VA	04-06	E/ED/F/G
CHH-39	CB1300	05	E/ED/U
	CB1300A	05	E/ED
	CB1300F1	03	E/ED/U
	CB1300F	03	E/ED/U
	CB1300S	05	U
	CB1300SA	05	E/ED
CHH-40	ST1300/A	02	E/ED
	ST1300/A	03	U
	ST1300	04	E/ED/U
	ST1300/A	06	E/ED
CHH-41	GL1500C	97-03	E/ED/F/G/SW/U
	GL1500CT	97-00	U
CHH-42	GL1800A	01-05	E/ED/F/U
	GL1800	06	E/ED/F/U
CHH-43	CBF500	04-06	E/ED/F
	CBF500A	04-06	E/ED/F
CHH-44	CB750K0		
CHH-45	CB750K1-K5		
	CB750' 76		
	CB750F' 76		
CHH-101M	CRF-250R	04-05	
CHH-102M	CRF-250R	06-08	
CHH-103M	CRF-450R	02-06	
CHH-46	CBX B/C	81-82	
CHH-47	CBX Z/A	79-80	

FOLLOWINGS BECOME NO LONGER AVAILABLE

CHY-21/CHY-35/CHY-44F/CHY-43 NO LONGER AVAILABLE
CHY-14/13/22/18 NO LONGER AVAILABLE

FUEL PETCOCK REPAIR KIT

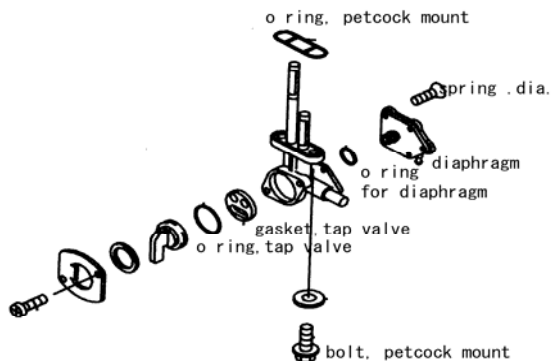

FCK-1	
Diaphragm	1
Diaphragm spring	1
O ring	1
O ring	1

HONDA			
VTR250		INTERCEPTOR	88-90
CB450SC		NIGHTHAWK	85-86
CMX450C		CUSTOM	86-87
CX500C	B/C		81-82
CX500D	B/C		81-82
FT500		ASCOT	82-83
GL500	B/C		81-82
GL500I	B/C		81-82
VF500F	E/F		84-85
VT500C		SHADOW	83-86
VT500E	D		83
VT500FT		ASCOT	84
CB550SC		NIGHTHAWK	83
CBX550F	G/2C		82
XL600V		TRANSALP	89-90
CB650SC		NIGHTHAWK	83-85
CBX650E	D		83
GL650D	D		83
GL650I		SILVERWING	83
CB700SC		NIGHTHAWK	84-86
VF700S		SABRE	84-85
CBX750F	E		84

FCK-2		kawa	yam
Diaphragm	1	43028-1015	diaphragm
O ring for dia.	1	670B1504	o ring
O ring, petcock mount	1	51039-010	2G2-24512-00
Gasket, tap valve	1	11009-1194(1530)	16G-24523-00
O ring, tap lever	1	92055-1027	2g2-24534-00

KAWASAKI			
KZ650	B3		79
KZ650	F1		80
KZ650	F2-F3		81-82
KZ650	H2/H3		82-83
KZ650E1			80
KZ700	A1		84
KZ750	E1/ES/E3		80-82
KZ750	H1-H4		80-83
KZ750	L1-L2		81-82
KZ750	R1	GPZ	82
KZ750	L3		83
ZX750	A1-A3		83-85
ZX750	G1/G2	GPZ750R	84-85
ZL900	A1/A2	ELIMINATOR	85-86
ZX900	A1-A3	GPZ900R	84-86
KZ1000	K1/K2		81-82
KZ1000	M1/M2		81-82
KZ1000	P1-P14		82-95
ZG1000	A1-A13		86-98
ZX1000	A1/A2		86-87
KZ1100	D1/D2	SPECTRE	82-83
KZ1100	L1	LTD	83
ZN1100	B1/B2	LTD 1100	84-85

FCK-2			
ZL1000	A1	ELIMINATOR	87
YAMAHA			
XS400	E-H		78-81
XS400S	G/H		80-81
XS650	F/G/H		79-81
XS650S	E/F/G/H/J/K		78-83
XJ700	N/NC/S/S/MAXIM		85-86
XJ700X	N/NC/S/SC		85-86
XS750S	E	->311211	78
XS750S	F		79
XS850S	G/H		80-81
XJ900			83-85
XJ900R	K	SECA	83

FCK-3		Yam	Kaw
Diaphragm	1	diaphragm	43028-1021
O ring for dia.	1	o ring	670B1504
O ring, petcock mount	1	2w6-24512-00	51039-003
Gasket, tap valve	1	3H3-24523-00	11009-1188
O ring, tap lever	1	3H3-24534-00	92055-1085

KAWASAKI			
Z400	J1/J2		80-81
KZ440	B1/B2		80-81
KZ440	A1-A4		80-83
KZ440	D1-D5		80-84
KZ440	G1		82
KZ500	B1-B4		79-82
KZ550	C1-C4		80-83
KZ550	A1-A4		80-83
KZ550	D1	GPZ	81
ZL600	A1/A2	ELIMINATOR	86-87
ZL600	B2/B3	ELIMINATOR	96-97
KZ650	H1	CSR	81
KZ750K/M		2 CYL	82-84

YAMAHA			
SR250	G/H/J		80-82
XJ400		MAXIM/SECA	82-83
XJ550	H/J/K	MAXIM	81-83
XJ550R	H/J/K		81-83
XZ550R	J/K	VISION	82-83
FJ600	L/N, LC/NC		84-85
SRX600	S, SC		86
XJ650	G/H/J/K	MAXIM	80-83
XJ650L	H		81
XJ650L	J/K	SECA	82-83
XJ650R	J		82
XV700		VIRAGO	84-87
XJ750R	H/J/K	SECA	81-83
XV750	H/J/K	VIRAGO	81-83
XV750M	K		83
XV920	J/K	VIRAGO	82-83
XV920M	K	VIRAGO	83
XV920R	H/J/K		81-83

FCK-4		kaw	
Diaphragm	1	43028-1033	
O ring,petcock mount	1	51039-003	
O ring for dia.	1	670B1504	
Gasket,tap valve	1	11009-1188	
O ring , tap lever	1	92055-1085	
KAWASAKI			
EX250	E1/E2		86-87
EN450	A1-A6	LTD	85-90
EN500	A1-A7	VULCAN	90-96
EX500	A1-A7		87-93
EX500	B1-B3	GPZ500S	88-91
EX500	D1-D5		94-98
KZ550	H1/H2	GPZ	82-83
KZ550F/M			83-84
ZX550	A1/A2		84-85
ZX600	C1-C5		88-92
ZX600A/B			85-87
KL650	A1-A12		87-98
KL650	B2	TENGA1	90
VN700	A1	VULCAN	85
ZN700	A1/A2	LTD	84-85
KZ750	N1/N2	SPECTRE	82-83
KZ750	F1	LTD	83

FCK-5		assy. ref	
Diaphragm	1	44300-45370	44300-34470/1
O ring,petcock mount	1	44300-45371	44300-49570
O ring for dia.	1	44300-45372	44300-00A70
O ring,tap lever	1	44300-45470	44300-34570
Gasket,dia	1	44300-45471	44300-43461
SUZUKI			
GSX400E	Z		82
GSX400E	E/F		84-85
GSX400S	Z		82
GSX400S	E/F		84-85
GS450E	D		83
GS450GA	Z/D/F		82-85
GS450L	F/G/H		85-87
GS450T	X/Z		81-82
GS450TX	Z/D		82-83
GS550E	F		85
GS550ES	3/E/F/G		83-86
GS550L	X/Z		81-82
GS550L	F/G		85-86
GS550M	Z		82
GS550T	X		81
GSX550E	F/G		85-86
GSX550E(U)	F		85
GSX550EF	F/G		85-86
GSX550ES	F/G		85-86
GR650	D		83
GR650X	D		83
GS650E	X/Z		81-82
GS650G	X/Z/D		81-83
GS650GL	X/Z/D		81-83
GS700E	F		85
GS700ES	F		85
GS750E	X/Z		81-82
GS750L	X		81
GS750T	Z/D		82-83
GSX750E	X/Z/D		81-83
GSX750L	X		81
GS850G	Z/D		82-83
GS850G	E/F/G		84-86
GS850GL	X-D		81-83
GS1000GL	X		81
GS1000S	Z		82
GS1100G	E/F/G		84-86
GS1100S	D	KATANA	83
GSX1100E	Z/D		82-83
GSX1100E	E/F/G		84-86
GSX1100EF	E/F/G		84-86

FCK-5			
GSX1100ES	D		83
GSX1100ES	E/F/G		84-86
GSX1100S	Z/D		82-83
GS1150E	E/F/G		85
GS1150ES	3/E/F		83-85
GSX-R1100	G/H/J	*Single diaphragm	86-88
GSX-R750	G/H	*type only	86-87

FCK-6		kawa	
Diaphragm	1	16126-1038	
O ring	1	92055-1068	
Spring,dia.	1	92081-1054	
O ring,petcock mount	1	43058-1001	
Gasket,tap valve	1	11009-1044	
Plain washer	2	92022-183	
KAWASAKI			
KZ1000	E1/E2	SHAFT	79-80
KZ1000	J1/J2/J3		81-83
KZ1000	A1/A2/A3	SHAFT	81-83
KZ1000	R1/R2	REPLICA	82-83

FCK-7		kawa	
Gasket,tap valve	1	43049-1017	
O ring,tap lever	1	92055-1111	
O ring,petcock mount	1	92055-1112	
Screw 3x5	2	92009-1123	
Bolt,mount	2	92001-1091	
Washers	2	92022-183	
KAWASAKI			
KLT60	A1	ATV	85
KD80	N1-N3		88-90
KLT110	A1-A3	ATV	84-86
KLT185	A1/A2	ATV	86-87
KL250	D1K-D12	KLR250	85-95
KZ250	L1/W1	CSR<D	82-83
EX305	B1	GPZ	83
KZ305	A1/A2/B1	CSR<D	81-82
KZ305	B2/B3		87-88
KL600	A1/BA/B2		84-86

FCK-8		kawa	
Gasket,Fuel tap cap	1	51037-010	
Gasket,fuel tap	1	92065-081	
O ring,tap valve 10mm	1	670B2010	
O ring,tap valve 14mm	1	670B2014	
KAWASAKI			
KH250	A5		76
KH400	A3/A4		76-77
KZ750B/G		2 CYL	77-78
KZ900	A4/B1		76
Z1 A/B			73-75
KZ1000	A1		77
KZ1000	B1-B4	LTD	77-80
KZ1000	C1/D1	Z1R	78
KZ1000	D3	Z1R	80
ZX1100	A1/A2	GPZ	83-84

FCK-9		Suz assy ref	
Diaphragm	1	Diaphragm	44300-45010
O ring for dia.	1	Oring	44300-45011
O ring, petcock mount	1	44348-31051	44300-44011
O ring,tap lever	1	44353-33154	
Gasket,tap	1	44341-33150	
SUZUKI			
GS400	B/C		77-78
GS400	C/N		78-79
GS400E	C/N		78-79
GS400X	B/C		77-78
GS425	N		79
GS425E	N		79
GS425L	N		79
GS750	B/C/N		77-79
GS750E	C/N		78-79
GS850G	N/T/X		79-81
GS1000	C/N		78-79
GS1000E	C/N		78-79
GS1000G	T/X		80-81

FCK-9			
GS1000S	N		79

FCK-10			
		suz	assy.ref
Diaphragm	1	diaphragm	44300-49172
O ring,petcock moun	1	44348-49170	44300-49170
O ring	1		
SUZUKI			
GSX250	T/X		80-81
GSX250E	T/X		80-81
GSX400E	T/X		80-81
GSX400S	T/X		80-81
GS450	T		80
GS450E	T/X		80-81
GS450S	T/X/Z		80-82
GS550	T/X		80-81
GS550D	T		80
GS550E	T/X		80-81
GS1000L	N		79

FCK-11			
		suz	assy.ref
Diaphragm,single	1	diaphragm	44300-17C00
O ring,petcock mount	1	44305-17C00	
SUZUKI			
GSX-R750	J/K/L		88-90
GSX-R1100	K/L		89-90
GSX-R1100	MC	CALIFORNIA	91
GSX-R1100N	NC	CALIFORNIA	92

FCK-12			
		yam	assy ref
Diaphragm	1	diaphragm	2J2-24500-00
O ring for dia.	1	o ring	2H7-24510-00
O ring,petcock mount	1	1J7-24512-00	2H7-24500-00
Gasket,tap valve	1	1J7-24523-00	
O ring,tap lever	1	1J7-24534-00	
Gasket	1	1J7-24522-00	
YAMAHA			
XS360C/D			76-77
XS400D			77
SR500	E/F/G/H		78-81
SR500			82-84
SR500			88
SR500			91-93
XS500	E		78
XS650	E		78
XS750	E/E/F		77-79
XS1100	E/F/G/H		78-81

FCK-14			
O ring,petcock moun	1	4X8-24512-00	
O ring	1	4X8-24534-00	
Screw 3x8	2	98580-03008	
Washer	2	90202-06010	
Bolt, 6-15	2	90149-06011	
YAMAHA			
YZ80	S-G		86-95
YZ125	S-D		86-92
WR250ZB			91
YZ250	S-D		86-92
YZ250WR	W/A		89-90
YZ490	S-A		86-90
XT600	U/UC/W/WC		88-89
XT600H			87
XT600N			87
XT600Z			84-88

FCK-15			
		yam	assy ref.suz
O ring,petcock moun	1	214-24512-00	44300-22D00/01
O ring	1	1A0-24152-00	
Bolt 6-15	2	90149-06011	
Washer	2	90202-05187(06010)	
SUZUKI			
RGV250	M/N/P/R		91-94
YAMAHA			
YZ80	G/J/K/L/N		80-85
YZ125	D/E/F/J/K/L/N		77-85

FCK-16			
		yam	
O ring,petcock mount	1	214-24512-00	
O ring,tap lever	1	1A0-24512-00	
Gasket	1	498-24522-00	
Bolts	2	90149-06011	
Washers	2	90202-06010	
YAMAHA			
RD250LC			82
RD350LC			82

FCK-17			
		yam	assy ref
Diaphragm	1	diaphragm	29L-24500-02
O ring for dia.	1	o ring	
O ring,petcock moun	1	2W6-24512-00	
O ring,tap lever	1	3H3-24534-00	
Gasket	1	gasket	
SUZUKI			
DR250		DUAL SPORT	94-95
DR350		DUAL SPORT	94-95
YAMAHA			
RD250			85
RD250YPVS			83-84
RZ250RN			84-85
TDR250			88
RD350			85
RD350LCF			88
RD350YPVS			83-84
RZ350RN			84-85
FZ600	S/T/U/US		86-88

FCK-18			
		kawa	
O ring,petcock moun	1	92055-1300	
O ring,tap lever	1	92055-1299	
Screw 3x8	2	92009-1386	
Bolt,petcock mount	2	187B0616	
KAWASAKI			
KX60	B1-B14		85-98
KDX80	C1-C5		84-88
KX80	G1/G2/J2/L1-L3		85-92
KX80	N1-N3/R1/RT/T1-T4/R5-R8		88-97
KX125	D1/E1/E2/FA/G1/H1-H3		85-93
KLT200	C2/C3		84-85
KLT250	C2/C3		84-85
KX250	C2/D1/D2/E1/F1/G1/H1/H2		84-92
KX500	A2/B1/B2/C1/D1/E1-E9		84-97

FCK-19			
		kawa	
Gasket,tap	1	43049-1017	
O ring,petcock moun	1	92055-1348	
O ring,tap lever	1	92055-1111	
Screw 3x8	2	92009-1123	
Bolt,petcock mount	2	187B0616	
KAWASAKI			
KDX200	C1-C3/E1-E6		86-94
KDX200	H1-H4		95-98
KDX220	A4/A5		97-98
KDX250	D1-D4		91-94
KSF250	A1-A11		87-97
KLX650	A1-A3		93-95
KLX650	D1		96

FCK-20			
Diaphragm	1	43028-1068	
O ring,petcock moun	1	92055-1112	
O ring	1	92055-1377	
Spring,tap lever	1	92144-1119	
Bolt, 6 x 16	2	92150-1358	
Washers	2	92022-183	
KAWASAKI			
ZX600	D1-D4		90-93
ZX750	F1-F4		87-90

FCK-21		kawa	
O ring,petcock moun	1	92055-1112	
O ring	1	92055-1419	
Spring,tap lever	1	92144-1119	
Gasket,tap valve	1	43049-1066	
Bolts,	2	92001-1091	
Washers	2	92022-183	
KAWASAKI			
ZR550	B1-B5	ZEPHYR	90-94
ZR750	C1-C4	ZEPHYR	91-94
ZR1100	A1/A2		92-93
SUZUKI			
GSF600S	T/V/W		96-98
GSF1200S	V/W		97-98

FCK-22		kawa		assy ref yama	
O ring,petcock moun	1	92055-1112		3LD-24510-00	
O ring,tap lever	1	92055-1419		3JD-24500-01	
Gasket,tap	1	43049-1066		2VE-24500-01	
Screw 3x8	2	220B0308		3FY-24500-00	
Bolts	2	132G0612		2RH-24500-01	
				assy ref suz	
				44300-15D00	
				44300-15D20	

KAWASAKI					
KX125	J1/J2			92-93	
KX125	K1-K4			94-97	
KX250	J1/J2			92-93	
KX250	K1-K3			94-96	
ZX400	L1/L2	ZXR400		91-92	
ZX750	P1-P3			96-98	
ZX900	B1-B4			94-97	
SUZUKI					
DR250	L/M/N/P/R			90-93	
DR350	L/M/N/P/R/S			90-95	
YAMAHA					
YZ85V				06	
YZ80				94-98	
TZR125				87-93	
DT125RE				05-06	
DT125X				05-06	
TW125				99-03	
XVS125 DRAGSTAR				00-04	
YZ125				93-98	
YZ125				05-06	
XT225E				92-00	
YZ250				93-98	
YZ250				05-06	
YZ250F				05-06	
WR250FT/FV				05-06	
XVS250 DRAGSTAR				01-04	
XT350				94-00	
YZ450F				05-06	
WR450F				05-06	
FZR600	W/WC/A/AC			89-90	
FZR600A				91	
FZR600B				91	
FZR600R	A/AC/B/BC/D/DC			90-92	
FZR600R	E/EG/F/FC/G/GC			93-95	
FZR600R	H/HC/H/JC/K/KC			96-98	
FZS600 FAZER				98-03	
XT600E	A/B/D/E/F			90-94	
XT600EH				90	
XT600EN				90	
XT600Z				90	
XVS650 DRAGSTAR				97-02	
XVS650A DRAGSTAR CLASSIC				98-06	
XT660				91	
XT660Z				91-93	
XTZ750	SUP	TENERE			
TDM850				91-95	
TDM850				99-01	
TRX850				96-97	
XJ900S DIVERSION				95-01	
YZF1000R				96-00	
YZF-R1				98-01	
FZS1000 FAZER				01-05	
XV1100A DRAGSTAR				00-06	
XV1100 DRAGSTAR				99-02	
XVZ1300 ROYAL STAR				96-00	
XVZ1300TF ROYAL STAR VENTURE				00	
XV1600 WILD STAR				99-02	

FCK-23		suz	
O ring,petcock mount	1	44348-28070	
O ring	1	44346-28070	
O ring	1	44353-32470	
Spring,tap lever	1	44357-32470	
Bolts	2	09128-06006	
Washers	2	09168-06026	

SUZUKI			
GN125	Z/D		82-83
GN125E	M/N/P/R		91-94
SP125	G/H/J		86-88
SP200	G/H/J		86-88
GN250	F		85
GN250	J		88
SP370	C/N		78-79
GN400T	X/Z		81-82
GN400X	T/X		80-81
SP400	T		80

FCK-24		assy ref	
Diaphragm assy(dou	1		43000-17E00/20
O ring,petcock moun	1	44305-17C00	44300-41C00/01
Spring,tap lever	1		44300-46E00
Bolts 6 x 20	2		
Oil seal	1		
Screws	4		
Spring,diaphragm*	1		

SUZUKI			
GSX-R600W	N/P		92-93
GSX-R750	J/K/L		88-90
GSX-R750	M/N		91-92
GSX-R750W	P/R/S		93-95
GSX-R1100	K/L		89-90
GSX-R1100	M/N		91-92
GSX-R1100	V/W		97-98
GSX-R1100W	P/R/S/T		93-96

FCK-25		assy ref	
Diaphragm	1		
O ring for dia.	1		
O ring,petcock moun	2	2W6-245412-00	
Gasket,tap valve	2	3H3-24523-00	
O ring,tap lever	2	3H3-24534-00	
YAMAHA			
XJ1100	J	MAXIM	82
XS1100L	G/H		80-81
XS1100S	F/G/H		79-81

FCK-26		assy ref	
Diaphragm	1	44300-20C00	
Gasket for cover	1		
Gasket,petcock moun	1		
O ring	1		
Spring, tap lever	1		
SUZUKI			
GSX600F	J-V	KATANA	88-97
GSX750F	K-V	KATANA	89-97

FCK-27		assy ref	
Diaphragm	1	44300-48B10/11	
Gasket for cover	1		
O ring,petcock moun	1		
O ring	1		
Spring,tap lever	1		
Spring,diaphragm	1		
SUZUKI			
GSX1100F	J-P		88-93

FCK-28			
		kaw	
Gasket,tap valve	1	43049-1066	
O ring,tap lever	1	92055-1419	
O ring,petcock moun	1	92055-1386	
O ring,petcock moun	1	92055-1387	
Screw	2	92009-1123	
KAWASAKI			
ZX600	E1-E5	ZZR600	93-98
ZX600	F1-F3		95-97
KLX650	G1C2		93-94
ZX750	H2		90
ZX750	K1/K2	ZX-7R	91-92
ZX750	J1/J2	ZX-7	91-92
ZX750	M1/M2	ZX-7R	93-94
ZX750	L1-L3		93-95
ZX1100	C1/C2	ZX-11	90-91
ZX1100	G3-G4	ZZR1100	92-93
ZX1100	D1-D6	ZZR1100 ZX11	93-98

FCK-30			
			assy ref
Diaphragm	1	3AL-24500-00	
O ring,petcock moun	1		
Gasket,tap valve	1		
O ring	1		
Screw 3 x 8	2		
YAMAHA			
XV750	U/W/A/B/D/E/F/G/H		88-96

FCK-31			
		yama	assy ref
O ring,petcock moun	1	4x8-24512-00	3JB-24500-03
Gasket	1	gasket	
O ring	1	3AJ-24534-00	
O ring	1	o ring	
O ring,tap valve	1	3AJ-24523-00	
Screw	2	98580-03008	
YAMAHA			
XV535	A/B/D/E/F/G/H/J/K		90-98

FCK-32			
		yam	assy ref
Diaphragm	1	diaphragm	4BP-24500-01
O ring ,petock moun	1	4X8-24512-00	
Gasket,tap valve	1	2AJ-24523-00	
O ring,tap lever	1	3AJ-24534-00	
Bolt	2	90149-06008	
YAMAHA			
XJ600S	D/E/F/G/H		92-96

FCK-33			
		yam	assy.ref
O ring,petcock moun	1	214-24512-00	26H-24500-00
O ring	1	o ring	
Spring,tap lever	1	spring	
Bolt	2	90149-06011	
Washers	2	90202-06010	
YAMAHA			
FZ750	S/T/U		86-88
FZR1000	W/A/B/D/E/F/G		89-95
FJ1200	U/W/A/B/D/E		88-93

FCK-34			
			assy ref
O ring,petock mount	1	44300-21E00	
O ring	1	44330-21E10(00)	
Gasket,tap valve	1		
Screw 3x8	2		
SUZUKI			
RF600R	R/S/T		94-96
RF900R	R/S/T/V		94-97

FCK-35			
			assy ref
Diaphragm	1	44300-33E01/00	
O ring,petcock moun	1		
Spring,diaphragm	1		
Screw 4x14	4		
SUZUKI			
GSX-R600	V/W		97-98
GSX-R750	T/V/W		96-98

FCK-36			
			assy ref
Diaphragm	1	16970-MN5-003	
Spring	1		
Screw	4		
(BASED ON ASSY NO. 16970-MN5-003)			
HONDA			
GL1500 GOLDWING			88-90
GL1500A ASPENCADE			91-95
GL1500I INTERSTATE			91-95
GL1500SE GOLDWING			91-95

FCK-37			
			assy ref
Diaphragm	2	16950-MW3-670	
O ring	2		
Spring	1		
HONDA			
CB750	NIGHTHAWK		91-96
CB750FII			97-99
CB750FII			01

FCK-38			
			assy ref
Diaphragm	2	16950-MZ2-010	
O ring	1	16950-MS2-003/013	
Spring	1		
HONDA			
CBR1000F			90-95

FCK-39			
			assy ref
Diaphragm	2	16970-MR5-000	
Spring	1		
HONDA			
PC800		PACIFIC COAST	89-98

FCK-1R			
Diaphragm	2	Diaphragm added	
Diaphragm spring	1		
O ring	1		
O ring	1		

HONDA			
VTR250		INTERCEPTOR	88-90
CB450SC		NIGHTHAWK	85-86
CMX450C		CUSTOM	86-87
CX500C	B/C		81-82
CX500D	B/C		81-82
FT500		ASCOT	82-83
GL500	B/C		81-82
GL500I	B/C		81-82
VF500F	E/F		84-85
VT500C		SHADOW	83-86
VT500E	D		83
VT500FT		ASCOT	84
CB550SC		NIGHTHAWK	83
CBX550F	C/2C		82
XL600V		TRANSALP	89-90
CB650SC		NIGHTHAWK	83-85
CBX650E	D		83
GL650D	D		83
GL650I		SILVERWING	83
CB700SC		NIGHTHAWK	84-86
VF700S		SABRE	84-85
CBX750F	E		84

FCK-41			
Diaphragm	1	large	
Diaphragm	1	small	
o ring	1		
Spring	1		
HONDA			
GL1500CF VALKYRIE INTERSTATE			97-04
GL1500CT VALKYRIE TOURER			97-00

FCK-44	
Diaphragm	1
Tap rubber gasket	1
Mount o ring	1
O ring	1
Spring	1
YAMAHA	
XJR1200	95-97
XJR1300	99-06
XJR1300SP	99-01
KAWASAKI	
ZX1100E1-E3 GPz	95-97
ZR1100D1-D3 ZRX	97-99
ZR1200C3H	04
ZR1200A1P-A3P	00-03
ZR1200A4H/A5H	04-05
ZR1200A6F ZRX	06
ZR1200B1P-B3P	01-03
ZR1200B4H	04
VN1800A1-A4 VULCAN	95-98
VN1800B1-B8	96-03
VN800B9P/B10P	04-05
VN800C1/C2	99-00
SUZUKI	
GSF1200 BANDIT	01-05
GSF1200S BANDIT	01-05

Spring, dia. is not included in the kit except FCK-35,FCK-27,FCK-24.
So, stocked Diaphragm spring should be used.

Each kit contains different parts.
Check details mentioned in order to order the correct item.

REMARKS:
FCK-29 IS NO LONGER AVAILABLE

FUEL PETCOCK ASSY & FILTER UNIT

YAMAHA

FPC-201	DT100C	76
	DT125C	76
	DT175C	76
FPC-202	DT50M	80
	RD50M	80
	TY50M	80
	DT80H/J/K	81-83
	YZ80A/B/C	74-76
	YZ80D/E/F	77-79
	DT100D	77
	DT100E/F/G	78-80
	DT100H/J/K	81-83
FPC-203	DT100A/B	74-75
	AT2/3	72-73
	CT2/3	72-73
	DT125A/B	74-75
	DT175A/B	74-75
	DT250A/360A	74
	DT250B/C	75-76
	DT400B/C	75-76
	XT500G/H	80-81
	XT500C/D/E/F	76-79
	FPC-204	RD250LC
RD350LC		82
FPC-205	YZ80G/H/J/K	80-83
	YZ80L/N	84-85
	YZ100D/E/F	77-79
	YZ100G/H	80-81
	YZ100J/K	82-83
	YZ125E/F/G/H	78-81
	YZ125J/K/L/N	82-85
	YZ250C/D/E/F	76-79
	YZ250G/H/J/K	80-83
	YZ250L/N	84-85
FPC-206	XVZ12TK	83
	XVZ12TDK	83
FPC-207	RD80LC	82
FPC-208R	XS1/XS1B/XS2	70-72
	TX650A/B	74-75
	TX750/750A	73-74
FPC-209	DT50LC	94-00
FPC-211	TY125	86-92

SUZUKI

FPC-301	TS100K-B	73-77
	TS125K-B	73-77
	TS185K/L/M	73-75
	TS815B/C/N	77-79
	TS250K/L/M/A	73-76
	TC100K-B	73-77
	TC125J-B	72-77
	TC185L/M	74-75
	FPC-302	TS100C/N
TS125C/N		78-79
TS250B/C/N		77-79
GP125C/N/X		77-79
RM125M-C		75-78
FPC-303	TS100T/X	80-81
	TS125T/X	80-81
	TS185T/X	80-81
	TS250T/X	80-81
	TS100ERN-ERX	79-81
	TS125ERT/ERX	80-81
	TS185ERT/ERX	80-81
	TS185ERZ	82
	TS185ERK	89

FPC-303	TS185ERN-ERR	92-94
	GN125Z/D	82-83
	GN125M-V	91-97
	GN250Z/D	82-83
	GN250F	85
FPC-304	DR125Z/D/E	82-84
	DR250Z-G	82-86
FPC-305	DR125SL-SN	90-92
	RD250SL-SN	90-92
	RD350SL-SN	90-92
FPC-306	GS550LT	80
	GS750ET	80
	GS750LT	80
	GS850GLT	80
	GS1000ET	80
	GS1000GLT	80
	GS1000ST	80
	GS1100ET	80
	GS1100LT	80
	FPC-307	GS300LZ/LD
GS300LF		85
GS450GAZ/GAD		82-83
GS450GAF		85
GS450LD		83
GS450LF-LJ		85-88
GS450TX		81
GS450TXD		83
GS550LX/LZ		81-82
GS550MZ		82
GS550TX		81
GR650D/XD		83
GS650EZ		82
GS650GLX-GLD		81-83
GS650GZ/GD		82-83
GS650MD		83
GS700EF/ESF		85
GS750LX	81	
GS750SD	83	
GS850GLX	81	
GS850GZ-GLD	82-83	
GS1000GLX	81	
GS1000SZ	82	
GS1000GZ-GLD	82-83	
GS1100GKZ-GKE	82-84	
GS1100SD	83	
FPC-308	GS450TZ/TXZ	82
	GS450ED	83
	GS750EX-ESD	81-83
	GS750TZ/TD	82-83
	GS1100EX	81
	GS1150ES3/ESF	83-85
	GS1150EF2-ESG	85-86
FPC-309	GS500EK-ET	89-00
FPC-310	GSF400N/P/R	92-94
	filter unit GS500EV-K2	89-0
FPC-311	GSX600FJ/FK	88-89
FPC-312	GSX600FL-GV	90-97
	GSX750FK-FV	89-97

FPC-313	GSX600F	98-06
	GSX750F	98-05
FPC-314	GSX-R750G/RG	86
	GSX-R750H	87
	GSX-R1100G/H/	86-88
FPC-315	GSX1100FJ-FP	88-93
FPC-317	VS800GLN-GLT	92-96
	VS800GLV-GLY	97-00
FPC-318	VS1400GLFH-GL	87-90
	VS1400GLFM-GL	91-94
	VS1400GLPH-GL	87-93
	VS1400GLPR-GL	94-00
FPC-319	RM80G-P	86-93
	RM80R-Y	94-00
	RM125N-J	79-88
	RM250N-H	79-87
FPC-320	RGV250M-R	91-94



REMARKS: FPC-310 Filter unit is used together with FPC-309 Fuel petcock assy.

CARB. FLOAT SET

Consist of FLOAT 1PC
FLOAT PIN 1PC



CHECK O.E.REF and Make sure if you are ordering the correct item before ordering.

STOCK NO.	O.E.REF			MODEL	
FLP-Y1	22F-14185-00 127-14186-00	FLOAT PIN	ATV	YFM80N-K MOTO-4 YFM-100 T-B CHAMP MOTO-4	85-98 90-94
FLP-Y2	3L6-14185-01 603-14186-00	FLOAT PIN	OFF ROAD	PW50H/J/K/N/S/T Y-ZINGER PW50U-L Y-ZINGER	81-87 88-99
FLP-Y3	2E9-14185-00 127-14186-00	FLOAT FLOAT PIN	OFF ROAD	PW80K/N/S/T/U/W Y-ZINGER PW80A-N1 Y-ZINGER	83-89 90-01
FLP-Y4	314-14185-00 127-14186-00	FLOAT FLOAT PIN	STREET OFF ROAD	DT125R RD125LC YZ60J/H/K YZ80 C-N1	82 82 81-83 83-01
FLP-Y5	2N7-14185-00 537-14186-00	FLOAT FLOAT PIN	OFF ROAD	YZ250G-U1 WR250Z D-J COMPETITION WR500ZD/ZE	80-88 92-97 92-93
FLP-Y6	4L0-14185-00 537-14186-00	FLOAT	STREET ATV	RD250LC/350LC RD350YPVS RD350LCFH/FN YFS200 U-N YFZ350 D-N	81-82 83-86 88 88-01 87-01
FLP-Y7	2A2-14985-00 537-14186-00	FLOAT FLOAT PIN	STREET	XS400D/2E/E/F/2F XS500E XS750E/SE/F/SF XS1100E/F/SF	77-79 78 78-79 78-79
FLP-Y8	256-14985-00 127-14186-00 (137-14186-00)	FLOAT FLOAT PIN	STREET	XS1/XS1B/XS2 TX650/A XS650B/C/D/E/F XS650SE/SF/SG XS650-2F TX750/A	70-72 73-74 75-79 78-80 79 73-74
FLP-Y9	1UY-14185-00 537-14186-00	FLOAT FLOAT PIN	ATV	YFM350ERT MOTO-4 YFM350XT WARRIOR YFM-350FWT/FWU BIG BEAR	87 87 87-88
FLP-Y10	21V-14185-00 127-14185-00		ATV	YFA1W/A/B/D/E DREESE YFA1F/G/H/J/K YTM200K/L/N TRI-MOTO YTM200ERN TRI-MOTO YTM225DXK/DXL/DXN TRI-MOTO YTM225DRN/DRS TRIMOTO YFM200N/DXS/DXT MOTO-4 YFM200DXU/DXW MOTO-4 YFM225S/T/U MOTO-4 YFB250D/E/F/G TIMBERWOLF YFB250FWF/FWG YFB250FEH/FWJ TIMBERWOLF YFB250UJ/UK TIMBERWOLF YFM250W/A/B MOTO-4	89-93 94-98 83-85 85 83-85 85-86 83-87 88-89 86-88 92-95 94-95 96-97 97-98 89-91
FLP-Y11	2VA-14185-00 (2LN-14185-00) 537-14186-00	FLOAT FLOAT PIN	STREET DUAL SPORT ATV	XV750U/W/A/B VIRAGO XV750D/E/F/G VIRAGO XV750H/H1/J1 VIRAGO XV1100U/W/A/B/D VIRAGO XV1100E/F/G/H VIRAGO XV1100J/SJ VIRAGO XT225E/F/G/H/J/K YFM250XN/XHN YFM350ER U-G MOTO-4 YFM350X U-N WARRIOR YFM350FW W-J BIG BEAR YFM-350FWBJ BIG BEAR YFM350FX J-N WOLVERINE YFM350UK YFM400FW E-98 KODIAK	88-91 92-95 96-97 88-92 93-96 97 93-98 01 88-95 88-01 89-97 97 97-01 98 93-98

STOCK NO.	O.E.REF			MODEL	
FLP-Y12	3H5-14985-00 (12R-14985-00) 537-14186-00	FLOAT		XS650 SPECIAL	81
		FLOAT PIN		XS650	81
				XS650SH	81
				XS650SJ HERITAGE	82
				XS650SK HERITAGE SPECIAL	83
				XS1100G/H	80-81
				XS1100SG/SH	80-81
				XS1100LG/LH	80-81
				XJ700XN/XS MAXIM	85-86
				XJ900	83-85
				XJ900RK SECA	83
				XJ900RL/RN	85
				XJ1100J MAXIM	81-82
				FJ600L/LC/N/NC	84-85
				FJ1100L/LC/N/NC	84-85
				FJ1200S/T/U/W	86-89
				FJ1200A/B/D/AE	90-93
		XJR1300	99		
		XJR1300SP	99		
		XJR1200SP	97-98		
		XJR1200	95-97		
FLP-Y13	1WG-14985-00 353-14186-00	FLOAT	STREET	FZR400 U/W/A	88-90
		FLOAT PIN		FZR700 T/U	87-88
				FZR750RT/RU	87-88
				FZR1000 T/U	87-88
				FZR400(1WG)	
				FZR400(25K)	
FLP-Y14	3GM-14985-00 53L-14186-00	FLOAT	STREET	FZR1000 W/A/B/D/E/F/G	89-95
		FLOAT PIN		YZF750RF/RH/RJ	94-97
				XJ600S/SN	92
				XJ600S	93-94
				XJ600N	95
				TDM850	91-98
				TRX850	96
				FZR400RR(3TJ1)	
				FZR400RR-SP(3TJ2)	
		FLP-Y16	5Y1-14385-00 6E5-14386-01 (689-14386-00)	FLOAT	OFF-ROAD
FLOAT PIN				TT250S/T	86-87
				TT350S/T	86-87
				TT600K/L	83-84
				TT600N/S	85-86
	DUAL SPORT			XT350N/S/T/U/W	85-89
				XT350A/B/D/E/F	90-94
				XT350G/H/J	95-97
				XT350K	98
				XT550J/K	92-93
				XT600L/N/S	84-86
				XT600T/U/W	87-89
FLP-Y17	2JN-14385-00 6E5-14386-01			FLOAT	STREET
		FLOAT PIN	OFF ROAD	TW200T/U/W/A/B	87-91
				TW200D/E/F/G	92-95
				BW350T/U	87-88
				XTZ660H	92-93
				XTZ660N	92-93
				TT600R	99
				TTR250N	01
			DUAL SPORT	XT600EA/EB/ED	90-92
				XT600EE/EF/EG	93-95
		XT600EH/EJ/EK/EL	96-99		
FLP-K1	16031-1009 92043-1066	FLOAT	STREET	KZ550A1/A2	80-81
		FLOAT PIN		KZ550C1/C2 LTD	80-81
FLP-K2	16031-1018 92043-1112	FLOAT	STREET	KZ550D1 GP	81
		FLOAT PIN		KZ550M1 LTD	83
				KZ550H1/H2 GP	82-83
FLP-K3	16031-030 16032-003/008	FLOAT	STREET	KZ550F1/F2 SPECTRE & LTD	83-84
		FLOAT PIN		ZX550A1-A3	84-86
FLP-K3	16031-030 16032-003/008	FLOAT	STREET	KZ750G1 LTD	80
		FLOAT PIN		KZ750B1-B4	76-79

STOCK NO.	O.E.REF		MODEL						
FLP-K4	16031-1013	FLOAT	STREET	KZ650H2	82				
				KZ700A1	84				
				KZ750M1 CSR	82				
				KZ750L3	83				
				KZ750R1 GP	82				
				KZ750J1/J2/J3	81-83				
				KZ750K1/K2	83-84				
				KZ1000K1/K2	81-82				
				KZ1000M1/M2	81-82				
				KZ1000R1/R2	82-83				
				KZ1000P1-P15	82-96				
				KZ1100A1-A3	81-83				
				KZ1100D1/D2	82-83				
				KZ1100L1 LTD	83				
FLP-S1	13252-31210	FLOAT	STREET	GS400B/C/XB/XC	77-78				
				GS425N/EN/LN	79				
				GS450LT/LX/LZ/TX/TZ/TXZ	81-82				
				GS450E/ST/EX/SX/EZ	80-82				
FLP-S2	13250-44080 13254-92311	FLOAT FLOAT PIN		GS450LD/TXD/ED	83				
				GS450GAZ/GAD	82-83				
				GS450GAF	85				
				GS450LF/FG/LH/LJ	85-88				
				GS550LT/ET	80				
				GS550LX/LZ	81-82				
				GS550MZ	82				
				GS650EX/EZ	81-82				
				GS650GX/GZ/GDGLX/GLZ/GLD	81-83				
				GS650MD	83				
				GS700EF/ESF	85				
				GS750LT/LX	82				
				GS750ET/EX/EZ	80-81				
				GS750TZ/TD	82-83				
				GS750ED/ESD	83				
				GS750SD KATANA	83				
				GS850GT/GX/GZ/GD	80-83				
				GS850GLT/GLX/GLZ/GLD	80-83				
				GS1000ST/ET/LT	80				
				GS1000GT/GX	80-81				
				GS1000GLT/GLX	80-81				
				GS1000SZ KATANA	82				
				GS1100ET/EX	80-81				
				GS1100GZ/GD	82-83				
				GS1100GD	83				
				GS1100GKZ/GKZ-2/GKD	82-83				
				GS1100GLZ/GLD	82-83				
				GS1100EZ/ED/ESD	82-83				
				GS1100KZE	84				
				GS1150ES3/ESE/EF/ESF/EF2/EG/ESG	83-86				
				FLP-S3	13250-43410 13254-20010	FLOAT FLOAT PIN		GS550LD	83
								GS550ED/ESD	83
GS550LF/LG	85-86								
GS550ES3/ESE/EF/ESF/ESG	83-86								
FLP-S4	13250-28A00 13254-92311	FLOAT FLOAT PIN		GSF600FJ/FJK KATANA	88-89				
				GSX1100FJ-FP KATANA	88-93				

CARB. ACCELERATOR PUMP REBUILD KIT

ACK-902



STOCK NO		MODEL	
ACK-901	Honda	CRF250R	04
		CR450R	02
	Yamaha	YZ426FN/FP	01-02
		YZ450FR	03
		YZ450FT	05
		YFZ450S/SET ATV	
ACK-902	Honda	CRF450R	03-05
ACK-903	Honda	CRF250R	05
	Yamaha	YZ250FN/FP/FR/FS/FT	01-05
	Suzuki	RM-Z250K4/K5	04-05
	Kawasaki	KX250N1/N2	04-05

Yamaha Diaphragm are all STD size

FRONT FORK REPAIR PARTS

	FSM	FSD	FSB	FRK
FORK OIL SEAL	2	2	2	1
DUST SEAL		2		1
DU BUSH Inner			2	1
DU BUSH Outer			2	1
CIR CLIP				1

FRONT FORK OIL SEAL KIT



MC ID	SIZE
FSM-001	36-48-10.5
FSM-002	34-46-10.5
FSM-003	35-48-10.5
FSM-003R	35-48-13
FSM-003T	35-48-11 DOUBLE SPRING
FSM-004	33-46-10.5
FSM-004D	33-46-11 DOUBLE SPRINGS
FSM-004DX	33-46-11 DOUBLE SPRINGS
FSM-005	31-43-10
FSM-006	37-48-12.5
FSM-007	37-48-10.5
FSM-008	31-43-12.5
FSM-009	27-39-10.5
FSM-009D	27-39-10.5 DOUBLE SPRINGS
FSM-010	27-37-7.5
FSM-012	31-41-9.1
FSM-014	30-40.5-10.5
FSM-016	30-42-10.5
FSM-023	33-46-12.5
FSM-025	36-48-11
FSM-025D	36-48-11 DOUBLE SPRINGS
FSM-026	38-50-10.5
FSM-026X	38-50-10.5
FSM-027	37-49-8/9.5
FSM-031	32-43-12.5
FSM-032	38-50-8/9.5
FSM-032D	38-50-8/9.5
FSM-033	40-52-8/9.5
FSM-034	30-42-11
FSM-035	32-44-10.5
FSM-036	43-55-10.5
FSM-037	39-52-11 DOUBLE SPRINGS
FSM-041	41-53-10.5
FSM-044	37-50-11 DOUBLE SPRINGS
FSM-044X	37-50-11 DOUBLE SPRINGS
FSM-045N	41-53-8/9.5
FSM-046	36-48-8/9.5
FSM-047	41-54-11 DOUBLE SPRINGS
FSM-048	43-54-11
FSM-048X	43-54-11
FSM-048D	43-54-11 DOUBLE SPRINGS
FSM-049	35-48-8/9.5
FSM-050	37-49-8/10.5
FSM-052	26-37-10.5
FSM-052D	26-37-10.5 DOUBLE SPRINGS
FSM-055	29-41-11
FSM-057	38-52-11
FSM-059	39-51-8/10.5
FSM-060	41-53-8/9.5
FSM-060D	41-53-8/10.5 DOUBLE SPRING
FSM-060X	41-53-8/9.5

MC ID	SIZE
FSM-061	43-55-9.5/10.5
FSM-061D	43-55-9.5/10.5 DOUBLE SPRING
FSM-061X	43-55-9.5/10.5
FSM-062	45-57-11
FSM-063X	43-54-9.5/10.5
FSM-064	YP150
FSM-069X	46-58-9.5/11.5 DOUBLE SPRINGS
FSM-070D	46-58-10.5 DOUBLE SPRING
FSM-070X	46-58-10.5/11
FSM-071XX	49-60-10
FSM-073XX	47-58-10
FSM-075	43-55-11
FSM-076D	33-45-8/10.5
FSM-077	48-61-11
FSM-078	48-58.1-8.5/10.5

FRONT FORK OIL SEAL & DUST SEAL KIT

< FSD > Oil seal & dust seal



FRONT FORK REPAIR KIT

Oil seal, Dust seal, In & Out bush & clip
Clips is Stainless steel made !

< FRK >



FRONT FORK OIL SEAL & BUSH SET

Oil seals & Inner + Outer bushes

< FSB >



MODEL APPLICATION LIST (FRONT FORK REPAIR PARTS)



MODEL			FSM	FSD	FSB	FRK
	HONDA					
CL50		72-74	FSM-003T			
Z50AK		78	FSM-003			
XL50		79	FSM-009			
MB50S		80	FSM-009			
MBX50		84-86	FSM-009			
MBX50SD(F)		85	FSM-055			
MBX50SD(H)		87	FSM-055			
MT50S(A)		80	FSM-009			
MTX50S(E)		84	FSM-005			
CB50J		80	FSM-009			
CRF70F		04-06	FSM-009	FSD-064		
SL70/K1		71-73	FSM-009			
XL70		74-75	FSM-009			
XL75		77-79	FSM-009			
XR75		76-78	FSM-009			
XR75/K1/K2		73-75	FSM-009			
CR80R		84	FSM-004D	FSD-016		
CR80R		85-86	FSM-004D	FSD-014		
CR80R		87-95	FSM-003T	FSD-002		
CR80R		96-02	FSM-044X			
CY80		79	FSM-009			
MCX80S		83	FSM-055			
MT80S		80	FSM-009			
MTX80(C)		82	FSM-005			
MTX80RS(D)		83	FSM-005			
MTX80RS(E)		84	FSM-003T			
MB80S(A)		80	FSM-009			
MBS80FWD(D)		83	FSM-055			
MBX80SW(D)		83	FSM-055			
MBX80SW2(D)		83	FSM-055			
MBX80SW(D)		83	FSM-055			
XL80S		80-85	FSM-009			
XR80		79-84	FSM-009			
XR80R		85-03	FSM-009	FSD-064		
CR80R		03-04	FSM-044X	FSD-050		
CRF80R		04-06	FSM-009D	FSD-064D		
CR85R		03-05	FSM-044X	FSD-050		
CR85RB		03-07	FSM-044X	FSD-050		
CR85R		04-07	FSM-044X	FSD-050		
SL90			FSM-010			
CT90		79	FSM-010			
CB100(K1/K2/K3)		76-78	FSM-008			
SL100K/K1		70-71	FSM-005			
CL100			FSM-010			
CRF100F		04-09	FSM-009D	FSM-064D		
XL100/K1		74-75	FSM-008			
XL100S		80	FSM-005			
XL100S		81-85	FSM-009			
XR100		81-84	FSM-009			
XR100R		85-03	FSM-009	FSD-064		
CB125B6/T			FSM-005			
CB125K3		74	FSM-012			
CB125S		76-82	FSM-009			
CB125		84-85	FSM-009			
CL125			FSM-010			
CM125C		82	FSM-005			
CR125R		74-78	FSM-003			
CR125R		84-86	FSM-036			
CR125R		87-89	FSM-048X	FSD-013X		
CR125R		92-93	FSM-063X	FSD-031	FSB-002	FRK-902
CR125R		94-96	FSM-061X	FSD-030	FSB-001	FRK-901
CR125R		97-98	FSM-069X	FSD-047X	FSB-003	FRK-903B
CR125		99-07	FSM-069X	FSD-049	FSB-003	FRK-903B
NES125		01-06	FSM-076D			
NX125		88-90	FSM-003T			
TL125/K1/K2/S		73-76	FSM-008			
VT125		01-06	FSM-003T	FSD-002		

MODEL			FSM	FSD	FSB	FRK
XL125K1		74-75	FSM-008			
XL125		76-78	FSM-008			
XL125R	C	82	FSM-004D			
XL125S		76-80	FSM-008			
XL125S		81-84	FSM-005			
XL125V		01-09	FSM-003T	FSD-002		
CRF150R		07-09	FSM-044X	FSD-050		
CRF150F		09	FSM-003T			
NES150		01-06	FSM-076D			
FES-150		98-03	FSM-004D			
CB/CL175K7		73	FSM-005			
CD175			FSM-012			
XL175	K1-K2		FSM-008			
XL175		76-78	FSM-008			
CM185T		78-79	FSM-005			
XL185		79	FSM-005			
XL185S	Z	79	FSM-008			
XL185S		80-83	FSM-005			
XR185		79	FSM-005			
ATC200S		84-86	FSM-016			
ATC200M		84-85	FSM-016			
ATC200X		83	FSM-016			
ATC200X		84-87	FSM-004	FSD-016		
CB200K		74	FSM-005			
CB200T		75-76	FSM-005			
CL200		74	FSM-005			
CM200T	A/B	80-81	FSM-005			
TR200		86-87	FSM-005			
TLR200		86-87	FSM-004			
XL200R		83-84	FSM-004			
XR200		80-84	FSM-005			
XR200R PROLINK		81-83	FSM-003T	FSD-002		
XR200R		84-02	FSM-001			
CRF230F		09	FSM-044X			
ATC250R		81-82	FSM-016			
ATC250ES		85-87	FSM-004	FSD-016		
ATC250SX		85-87	FSM-004			
ATC250R		83-84	FSM-003T	FSD-002		
ATC250R		85-86	FSM-037			
CR250		92-94	FSM-063X	FSD-031	FSB-002	FRK-902
CR250		95	FSM-061X	FSD-030	FSB-001	FRK-901
CR250		96	FSM-069X	FSD-047X	FSB-003	FRK-903B
CR250R		97-07	FSM-073XX	FSD-035	FSB-005	FRK-905
CRF250R		04-09	FSM-073XX	FSD-035	FSB-005	FRK-905
CRF250X		04-09	FSM-073XX	FSD-035	FSB-005	FRK-905
CB250N		79	FSM-004	FSD-016N		
CB250N(A/B)		80-81	FSM-004	FSD-016N		
CB250ND(C)		82	FSM-004D	FSD-016		
CB250RS		80	FSM-004			
CB250T	1/2		FSM-004	FSD-016N		
C-J250T		77	FSM-004			
CM250C(C)		82	FSM-005			
CMX250C		85-87	FSM-004D	FSD-014		
CMX250CD		86	FSM-004D	FSD-014		
CMX250C REBEL		97-00	FSM-004D	FSD-014		
CMX250C		09	FSM-004D			
CMX250C2 REBLE		99-00	FSM-004D	FSD-014		
FES250		98-00	FSM-004D			
MR250 ELSINORE		76	FSM-003T			
NSS250EX		06-07	FSM-004D			
NT250		74-76	FSM-003T			
NX250(J/K/L)		88-90	FSM-044			
VTR250		88-90	FSM-003T	FSD-002		
VT250C(S)		95	FSM-047			
VT250L		90	FSM-044			
XL250K/K1/K2		72-75	FSM-003T			
XL250		76	FSM-003T			
XL250K3/K4		78-79	FSM-003T			
XL250S	Z/A/B	79-81	FSM-003T			
XL250R		82-87	FSM-003T	FSD-002		
XR250		79-80	FSM-003T	FSD-002		
XR250L		91-96	FSM-047			
XR250R		81-82	FSM-044X			
XR250R	E/F	84-85	FSM-036			
XR250R		86-90-04	FSM-060X			

MODEL			FSM	FSD	FSB	FRK
ATC350X		85-86	FSM-003T			
CB350K4		72	FSM-004			
CB350G		73	FSM-004			
CB350F/F1		73-74	FSM-004			
CL350K/K1		74-75	FSM-004			
SL350/K		70-71	FSM-004			
SL350/K2		72	FSM-003T			
XL350/K1			FSM-003T			
XL350		76-78	FSM-003T			
XL350R		84-85	FSM-037	FSD-001		
XR350R(D/E/F)		83-85	FSM-047			
CJ360T		76	FSM-004D	FSD-016		
CJ360		76-77	FSM-004D	FSD-016		
CB360G		75	FSM-004			
CB400		79	FSM-004			
CB400A		78	FSM-004			
CB400F		75-77	FSM-004D			
CB400TI		78	FSM-004D	FSD-016		
CB400TII		79	FSM-004D	FSD-016		
CB400TZ		79	FSM-004	FSD-016N		
CB400T		80-81	FSM-004D	FSD-016		
CB400N		79-81	FSM-004	FSD-016N		
CB400N		82	FSM-004D	FSD-016		
CB1 400F		89-90	FSM-047	FSD-009		
CM400A		79-81	FSM-004D	FSD-016		
CM400E		80-81	FSM-004D	FSD-016		
CM400T		80-81	FSM-004	FSD-016N		
NS400R	F	85	FSM-044	FSD-003		
XR400R		96-04	FSM-048X			
CB450(K5-K7)		72-74	FSM-003			
CB450N		85	FSM-004			
CB450SC		82-86	FSM-004D	FSD-016		
CB450T		82	FSM-004D	FSD-016		
CL450K5-K6		72-73	FSM-003			
CM450A		82-83	FSM-004D	FSD-016		
CM450C		82	FSM-004D	FSD-016		
CM450E		82-83	FSM-004D	FSD-016		
CMX450C REBEL		86-87	FSM-044	FSD-051		
CRF450R		02-08	FSM-073XX	FSD-035	FSB-005	FRK-905
CRF450R		09-10	FSM-078	FSD061	FSB-016	FRK-918
CRF450X		05-07	FSM-073XX	FSD-035	FSB-005	FRK-905
CB500		70-74	FSM-003T			
CB500	T-Y	96-00	FSM-044	FSD-051		
CB500S	W/X/Y	98-00	FSM-044	FSD-051		
CB500T		75-76	FSM-003T			
CR500		92-94	FSM-063X	FSD-031	FSB-002	FRK-902
CR500R		95	FSM-061X	FSD-030	FSB-001	FRK-901
CR500R		96-01	FSM-069X	FSD-047X	FSB-003	FRK-903B
CX500		79	FSM-004	FSD-016N		
CX500	A	80	FSM-004	FSD-016N		
CX500	B	81	FSM-004D	FSD-016		
CX500C	A	80	FSM-004	FSD-016N		
CX500C	B/C	81-82	FSM-004D	FSD-016		
CX500E		82	FSM-044			
CX500D	A	80	FSM-004			
CX500TC	C	82	FSM-044	FSD-003		
FT500C		82-83	FSM-044	FSD-003		
GB500 CLUBMAN		85	FSM-003T			
GB500		89-90	FSM-003T	FSD-002		
GL500/I		81-82	FSM-003T	FSD-002		
GL500D	C	82	FSM-003T	FSD-002		
NX500	N-R	92-94	FSM-047			
VF500C		84-85	FSM-044	FSD-003		
VF500FII	E	84	FSM-044	FSD-003		
VF500F	E/F	84-85	FSM-044	FSD-003		
VT500C		83-84	FSM-044	FSD-003		
VT500ED	D	83	FSM-044	FSD-003		
VT500FT		83-84	FSM-044	FSD-003		
XBR500		85-87	FSM-003T			
XBR500S		88	FSM-003T			
XL500R	C	81-82	FSM-044X			
XL500S	Z/A/B	79-81	FSM-003T			
XR500R		79-80	FSM-003T			
XR500R		81-82	FSM-044			
XR500R		83-84	FSM-048			

MODEL			FSM	FSD	FSB	FRK
CB550/K		74-76	FSM-003T			
CB550F		75-77	FSM-003T			
CB550F/K		78	FSM-003			
CB550SC		83	FSM-044	FSD-003		
CBX550F		82	FSM-003T	FSD-002		
CBX550FII		82	FSM-003T	FSD-002		
CB600F		98-00	FSM-047	FSD-009	FSB-010	FRK-910
CB600F		01-07	FSM-047	FSD-009		
CB600F		08-10	FSM-047	FSD-009		
CB600FA		07-10	FSM-047	FSD-009		
CB600F2		00	FSM-047	FSD-009	FSB-010	FRK-910
CB600F2		01-02	FSM-047	FSD-009		
CBF600N/NA		04-09	FSM-047	FSD-009		
CBF600S/SA		04-09	FSM-047	FSD-009		
CBR600F		87-90	FSM-044	FSD-003		
CBR600F		91-98	FSM-047	FSD-009	FSB-010	FRK-910
CBR600F		99-00	FSM-048	FSD-037		
CBR600F		01-06	FSM-048X			
CBR600F4		99-00	FSM-048	FSD-037		
CBR600F4		01-02	FSM-048			
CBR600F1		01-02	FSM-048X			
CBR600FR		02	FSM-048X			
CBR600FS		01-02	FSM-048X			
CBR600RR		03-04	FSM-062			
CBR600RR		05-10	FSM-047	FSD-009		
FJS600 SILVERWING		01-03	FSM-060D	FSD-054		
FJS600A		03-04	FSM-060D	FSD-054		
FJS600D		03-04	FSM-060D	FSD-054		
VT600C		88-04	FSM-059	FSD-033		
VT600CD		93-04	FSM-059	FSD-033		
VT600CD2		99-02	FSM-059	FSD-033		
XL600L	D	83	FSM-037	FSD-001		
XL600R		83-87	FSM-037	FSD-001		
XL600V	H/J/K/L	87-90	FSM-047			
XR600L		93-00	FSM-048			
XR600R		85-99	FSM-048			
XR600R		00	FSM-048X			
CB650	Z-B	79-81	FSM-003	FSD-002		
CB650C		80	FSM-003	FSD-002		
CB650SC	C	82	FSM-044	FSD-003		
CB650SC NIGHTHAWK		83-85	FSM-037	FSD-001		
CBX650E		83	FSM-037	FSD-001		
CX650T		83	FSM-044	FSD-003		
CX650E	D	83	FSM-044	FSD-003		
CX650C	D	83	FSM-037	FSD-001		
GL650/I		83	FSM-044	FSD-003		
GL650D	D	83	FSM-044	FSD-003		
NT650	J/K/L	88-91	FSM-047	FSD-009		
NT650		98-00	FSM-047	FSD-009	FSB-010	
NT650V		98-05	FSM-047	FSD-009		
NTV650		88-91	FSM-047	FSD-009		
NX650		88-94	FSM-047			
SLR650		97	FSM-047	FSD-009		
XL650V		00-06	FSM-047			
XR650L		93-00	FSM-048			
XR650L		09	FSM-048X			
XR650R		00-07	FSM-070X	FSD-029	FSB-017	FRK-919
XRV650	J/K	88-89	FSM-048			
CB700SC		84-86	FSM-059			
NT700V		06-10	FSM-047	FSD-009		
NT700VA		06-10	FSM-047	FSD-009		
VF700C MAGNA		84-87	FSM-044			
VF700F INTERCEPTOR		84-85	FSM-044			
VF700S SABRE		84-85	FSM-044			
VT700C		84-85	FSM-037			
CB750A		76-78	FSM-003T			
CB750K1-K6		69-76	FSM-003T			
CB750K7		77	FSM-003T			
CB750C		80-82	FSM-003T	FSD-002		
CB750F	A/B/C	80-82	FSM-003T	FSD-002		
CB750F1/F2		77-78	FSM-003T	FSD-002		
CB750K	Z/A/B	79-81	FSM-003	FSD-002		
CB750FII	C	82	FSM-003T	FSD-002		
CB750FII		92-01	FSM-047	FSD-009	FSB-010	FRK-910
CB750 NIGHTHAWK		91-01	FSM-047	FSD-009	FSB-010	FRK-910
CB750L		79	FSM-003T	FSD-002		
CB750SC		82-83	FSM-044	FSD-003		

MODEL			FSM	FSD	FSB	FRK
CBX750F(E)		84	FSM-037	FSD-001		
NV750C2		99	FSM-045N	FSD-036		
RVF750R		94	FSM-047	FSD-009		
VF750C		82-84	FSM-044	FSD-003		
VF750C MAGNA		88	FSM-037	FSD-001		
VF750C		94-97	FSM-047	FSD-009		
VF750C		98-00	FSM-047	FSD-009	FSB-010	FRK-910
VF750C2		97	FSM-047	FSD-009		
VF750C2		98-00	FSM-047	FSD-009	FSB-010	FRK-910
VF750CD MAGNA DELUXE		95-96	FSM-047	FSD-009		
VF750S SABRE	C/D	82-83	FSM-044	FSD-003		
VF750F INERCEPTOR	D/E/F	83-85	FSM-037	FSD-001		
VF750F2 INTERCEPTOR		86-87	FSM-044	FSD-003		
VFR750F INTERCEPTOR	G/H	86-87	FSM-044	FSD-003		
VFR750F		88-89	FSM-047	FSD-009		
VFR750F		90-95	FSM-047	FSD-009	FSB-010	FRK-910
VFR750F		96-97	FSM-047	FSD-009		
VFR750R	J	88	FSM-048			
VT750C	D/E/F	83-85	FSM-037	FSD-001		
VT750C		97-01	FSM-045N	FSD-036		
VT750C		05-09	FSM-060D	FSD-054		
VT750CA		05-07	FSM-060D	FSD-054		
VT750C2		97-01	FSM-045N	FSD-036		
VT750C3		01	FSM-045N	FSD-036		
VT750CD3		01	FSM-045N	FSD-036		
VT750DC		01-03	FSM-047	FSD-009		
XLV750R	F	85	FSM-048			
XRV750	L-X	90-99	FSM-048X			
PC800		89-97	FSM-047	FSD-009		
VFR800	F1	98-01	FSM-047	FSD-009	FSB-010	FRK-910
VFR800		02-06	FSM-048X			
VFR800		02-09	FSM-048D			
VFR800A		02-09	FSM-048D			
VT800C		88	FSM-037	FSD-001		
CB900C		80-82	FSM-044			
CB900F	Z	79	FSM-003T			
CB900F	A	80	FSM-003T	FSD-002		
CB900F	B	81	FSM-044	FSD-003		
CB900F	C	82	FSM-037	FSD-001		
CB900FII	B	81	FSM-044	FSD-003		
CB900FII	C	82	FSM-037	FSD-001		
CB900F HORNET		02-03	FSM-048X			
CB900F HORNET		07	FSM-048X			
CBR900RR		93-99	FSM-062	FSD-011		
CBR900RR		00-03	FSM-048X			
CBR900RE		01-02	FSM-048X			
CB1000		94-95	FSM-048	FSD-037		
CB1000		96-97	FSM-048			
CB1000C		83	FSM-037	FSD-001		
CB1000R		09	FSM-048D			
CB1000RA		09	FSM-048D			
CBF1000		06-10	FSM-047	FSD-009		
CBF1000 ABS		06-10	FSM-047	FSD-009		
CBF1000S		07-10	FSM-047	FSD-009		
CBF1000T		07-10	FSM-047	FSD-009		
CBR1000F	H/J	87-88	FSM-047	FSD-009		
CBR1000F		90-95	FSM-047	FSD-009	FSB-010	FRK-910
CBR1000F		96	FSM-047	FSD-009		
CBR1000RA		09	FSM-048D			
CBR1000RR		04-07	FSM-048X			
CBR1000RR		08-09	FSM-048D			
CBX1000	Z/A	79-80	FSM-003T	FSD-002		
CBX1000	B/C	81-82	FSM-037	FSD-001		
GL1000		75	FSM-007			
GL1000 LTD		75	FSM-007			
GL1000K1-K2		75-76	FSM-007			
GL1000K3/Z		78-79	FSM-006			
RVT1000R		00-03	FSM-048X			
VF1000F	E/F/G	84-86	FSM-047	FSD-006		
VF1000FII	F/G	85-86	FSM-047	FSD-006		
VF1000R		85-86	FSM-047	FSD-009		
VTR1000 SP		00-06	FSM-048X			
VTR1000F FIRE STORM		97-03	FSM-047	FSD-009	FSB-010	FRK-910
VTR1000F FIRE STORM		05-06	FSM-047	FSD-009		
XL1000V VARADERO		99-01	FSM-048	FSD-037	FSB-014	FRK-915
XL1000V VARADERO		02	FSM-048	FSD-037		
XL1000V VARADERO		03-07	FSM-048X			
XL1000V VARADERO		08-09	FSM-048D			

MODEL			FSM	FSD	FSB	FRK
XL100VA		05-06	FSM-048X			
CB1100R	B	81	FSM-044	FSD-003		
CB1100R	C/D	82-83	FSM-037	FSD-001		
CB1100F	D	83	FSM-037	FSD-001		
CB1100SF		00	FSM-048X			
CBR1100XX		97-98	FSM-048	FSD-037	FSB-014	FRK-915
CBR1100XX		99-06	FSM-048	FSD-037		
GL1100A/1A/DA		80	FSM-037	FSD-001		
GL1100B/1B/DB		81	FSM-037	FSD-001		
GL1100C/1C/DC		82	FSM-037	FSD-001		
GL1100D/1D/DD		83	FSM-037	FSD-001		
GL1100D2D/AD		83	FSM-037	FSD-001		
ST1100		90-02	FSM-047	FSD-009	FSB-010	FRK-910
ST1100A		90-96	FSM-047	FSD-009	FSB-010	FRK-910
ST1100A		97-02	FSM-048	FSD-037	FSB-014	
VF1100C		83-86	FSM-047	FSD-006		
VF1100S		84-85	FSM-047	FSD-006		
VT1100C		85-86	FSM-047	FSD-006		
VT1100C		87-94	FSM-047	FSD-009		
VT1100C		95-00	FSM-047	FSD-009	FSB-010	FRK-910
VT1100C		01-04	FSM-047	FSD-009		
VT1100CII		95-96	FSM-047	FSD-009		
VT1100CII		97	FSM-047	FSD-009	FSB-010	FRK-910
VT1100CII		98	FSM-047	FSD-009		
VT1100CII		00-02	FSM-060D	FSD-054		
VT1100C3		98-00	FSM-047	FSD-009	FSB-010	FRK-910
GL1200		84	FSM-047	FSD-006		
GL1200A		84-87	FSM-047	FSD-006		
GL1200D	E	84	FSM-047	FSD-006		
GL1200I		84-87	FSM-047	FSD-006		
GL1200L		85	FSM-047	FSD-006		
CB1300		05-09	FSM-048D			
CB1300A		05-09	FSM-048D			
ST1300		02-09	FSM-062			
ST1300A		02-09	FSM-062			
VTX1300C		04	FSM-047	FSD-009		
VTX1300S		03-07	FSM-047	FSD-009	FSB-010	FRK-910
GL1500	J/K/L	88-90	FSM-047	FSD-009		
GL1500A		93-96	FSM-047	FSD-009	FSB-010	FRK-910
GL1500A		97-00	FSM-047	FSD-009	FSB-010	FRK-910
GL1500C		97-01	FSM-062	FSD-011		
GL1500CF		99-01	FSM-062	FSD-011		
GL1500CT		97-02	FSM-062	FSD-011		
GL1500CD		01-03	FSM-062	FSD-011		
GL1500I		91-96	FSM-047	FSD-009		
GL1500SE		91-96	FSM-047	FSD-009	FSB-010	FRK-910
GL1500SE		97-00	FSM-047	FSD-009	FSB-010	FRK-910
GL1800		01-06	FSM-062			
GL1800A		01-03	FSM-062			
VTX1800C		02-04	FSM-062			
KAWASAKI						
AE50	A1	81	FSM-009			
AR50		82	FSM-009			
KX60	B15-B18	99-02	FSM-034			
KX65A		00-10	FSM-004DX	FSD-014		
AE80	A1/1A1	81-82	FSM-009			
AR80	A1/1A1	81-82	FSM-009			
KD80/A2		75-76	FSM-009			
KD80N1-N3		88-90	FSM-009			
KX80E1	E1	83	FSM-004	FSD-016N		
KX80T2-T4		92-94	FSM-046	FSD-027		
KX80	W1-W3	98-00	FSM-046	FSD-027		
KX85	A1-A3	01-03	FSM-046	FSD-027		
KX85	B3-B4	03-04	FSM-046	FSD-027		
KX85		05	FSM-046	FSD-027		
KX85	A	06-10	FSM-046X	FSD-027		
KE100		76-91	FSM-014			
KD100		76-79	FSM-009			
KV100		76	FSM-014			
KH100		76-77	FSM-009			
KM100		76-81	FSM-009			

MODEL			FSM	FSD	FSB	FRK
KX100B2-B6		92-96	FSM-046	FSD-027		
KX100	C1-C3	98-00	FSM-046	FSD-027		
KX100	D1-D5	01-05	FSM-046	FSD-027		
KX100	B6F	06	FSM-046X	FSD-027		
KX100	D7F	07	FSM-046X	FSD-027		
KLX100	A6F	06	FSM-034			
KLX110	A	02-09	FSM-034			
KLX110	C	10	FSM-034			
KLX1100A7F		07	FSM-034			
BN125	A	04-09	FSM-004D			
EN125	A1	A2	FSM-004			
KD125		75-79	FSM-008			
KE125	A3-A8	76-81	FSM-008			
KH125	A1-A2	77-78	FSM-009			
KS125		74-75	FSM-005			
KX125		90	FSM-060X	FSD-028		
KX125		91-95	FSM-061X	FSD-030	FSB-001	FRK-901
KX125		96-99	FSM-069X	FSD-047X	FSB-003	FRK-903B
KX125	L2/L3	00-01	FSM-069X	FSD-049	FSB-003	FRK-903B
KX125	L4/M1	02-03	FSM-078	FSD-061	FSB-004	FRK-904
KX125	M2	04	FSM-078	FSD-061	FSB-016	FRK-918
KX125		05	FSM-078	FSD-061	FSB-016	FRK-918
KDX175	A1-A3	80-82	FSM-001			
KDX175	B1-B2	81-82	FSM-001			
KE175	F1	82	FSM-009			
KE175	D1-D4	79-82	FSM-009			
KDX200		83-85	FSM-026			
KDX200	C1-C3		FSM-036			
KDX200	E1-E4	89-92	FSM-036			
KDX200	E5-E6	93-94	FSM-060X	FSD-028		
KDX200	H1-H6	95-02	FSM-061X			
KDX200		04-05	FSM-061X		FSB-001	
KDX200	H6F	06	FSM-061X		FSB-001	
KZ200	A1-A2	77-79	FSM-031			
KDX220	A4-A9	97-02	FSM-061X			
KDX220	A11-A12	04-05	FSM-061X		FSB-001	
KDX220	H6-H8	00-02	FSM-061X			
EL250	B2-B3	88-89	FSM-025D	FSD-010		
EL250	D4-D5	93-95	FSM-025D	FSD-010		
EL250	E1-E4	91-94	FSM-025D	FSD-010		
EL250	F6	03	FSM-025D	FSD-010		
EX250		83	FSM-031			
EX250	E1/E2	86-87	FSM-003T	FSD-002		
EX250	F2-F12	88-98	FSM-025D	FSD-010		
EX250	F13-F16	99-02	FSM-025D	FSD-010		
EX250	F18-F19	04-05	FSM-025D	FSD-010		
EX250	F6F-E7F	06-07	FSM-025D	FSD-010		
EX250	J	09-10	FSM-044	FSD-051		
KDX250	D1-D4	91-94	FSM-061X	FSD-030	FSB-001	FRK-901
KE250		77-79	FSM-003			
KL250	A1-A2	78-79	FSM-003			
KL250	A3-A5	80-82	FSM-001			
KL250	C1-C2	83-84	FSM-001			
KL250	D2-D18	85-01	FSM-001			
KL250	D21-D22	04-05	FSM-001			
KLX250	A1-A2	79-80	FSM-001			
KLX250	D1-D4	93-96	FSM-061X	FSD-030	FSB-001	FRK-901
KLX250	E1/E3	93-95	FSM-061X	FSD-030	FSB-001	FRK-901
KLX250	H6F	06	FSM-061X	FSD-030	FSB-001	FRK-901
KLX250	T	09-10	FSM-061X	FSD-030	FSB-001	FRK-901
KLX250	W	09-10	FSM-061X	FSD-030	FSB-001	FRK-901
KX250	H2	91	FSM-061X	FSD-030	FSB-001	FRK-901
KX250	J1/J2	92-93	FSM-061X	FSD-030	FSB-001	FRK-901
KX250	K1/K2	94-95	FSM-061X	FSD-030	FSB-001	FRK-901
KX250	K3-K5	96-98	FSM-069X	FSD-047X	FSB-003	FRK-903B
KX250	L1-L3	99-01	FSM-069X	FSD-049	FSB-003	FRK-903B
KX250	L4	02	FSM-078	FSD-061	FSB-004	FRK-904
KX250	M1	03	FSM-078	FSD-061	FSB-004	FRK-904
KX250	M2	04	FSM-078	FSD-061	FSB-016	FRK-918
KX250	R1	05	FSM-078	FSD-061	FSB-016	FRK-918
KX250	R6F	06	FSM-078	FSD-061	FSB-016	FRK-918
KX250	R7F	07	FSM-078	FSD-061	FSB-016	FRK-918
KX250F	N1-N2	04-05	FSM-078	FSD-061	FSB-016	FRK-918
KX250F	T	06-10	FSM-073XX	FSD-035	FSB-005	FRK-905
KXT250 TECATE	A1-A2	84	FSM-001			

MODEL			FSM	FSD	FSB	FRK
KXT250	B1-B2	86-87	FSM-041			
KZ250	A1-A4	79-82	FSM-004			
KZ250	C1-C3	80-82	FSM-031			
KZ250	J1	81	FSM-004			
KLX300	A2-A10	97-05	FSM-061X	FSD-030	FSB-001	FRK-901
KLX300	A6/A7F	06-07	FSM-061X	FSD-030	FSB-001	FRK-901
KZ305	A1/A2	81-82	FSM-004	FSD-016N		
KZ305	B1	82	FSM-004	FSD-016N		
KZ305	B2/B3	87-88	FSM-004	FSD-016N		
ZX400	J1/J2		FSM-045N			
ZX400	K1/K2		FSM-047			
ZX400	L1-L2	91-92	FSM-047			
KH400	A3-A5	76-78	FSM-004			
KZ400	A1-A2	77-78	FSM-004	FSD-016N		
KZ400	B1-B2	78-79	FSM-004	FSD-016N		
KZ400	C1	78	FSM-004	FSD-016N		
KZ400	D2-D4	75-77	FSM-004	FSD-016N		
KZ400	G1	79	FSM-004			
KZ400	H1	79	FSM-004	FSD-016N		
KZ400	J1-J3	80-82	FSM-025			
KZ400	M1	83	FSM-003T			
KZ400	S/S2/S3	75-77	FSM-004	FSD-016N		
KZ440	A1-A4	80-83	FSM-004	FSD-016N		
KZ440	B1/B2	80-81	FSM-004	FSD-016N		
KZ440	C1-C2	80-81	FSM-004			
KZ440	D1-D5	80-83	FSM-004	FSD-016N		
KZ440	D6	84	FSM-004			
KZ440	G1	82	FSM-004	FSD-016N		
KZ440	H1-H2	82	FSM-004			
KLX450	A	09	FSM-078	FSD-061		
KX450F	D	08	FSM-078	FSD-061		
EN450	A1-A6	85-90	FSM-025D	FSD-010		
EN500	A1-A7	90-96	FSM-025D	FSD-010		
EN500	C1-C5	96-00	FSM-060X	FSD-036		
EN500	C8-C10	03-05	FSM-060D	FSD-054		
EN500	C	06-09	FSM-060D	FSD-054		
ER500	A1-A3	97-99	FSM-044	FSD-051		
ER500	C1/C2	01-03	FSM-044	FSD-051		
ER500	D1	01	FSM-044	FSD-051		
EX500	A1-A7	87-93	FSM-025D	FSD-010		
EX500	B1-B4	88-91	FSM-025D	FSD-010		
EX500	D1-D12	94-05	FSM-044	FSD-051		
EX500	D	06-09	FSM-044	FSD-051		
EX500	E9	02	FSM-044	FSD-051		
KZ500	B1-B2	79-80	FSM-025D			
KX500	E1	89	FSM-070X	FSD-029		
KX500	E2	90	FSM-060X	FSD-028		
KX500	E3-E8	91-96	FSM-061X	FSD-030	FSB-001	FRK-901
KX500	E10-E14	97-02	FSM-069X	FSD-047X	FSB-003	FRK-903B
KZ550	A1-A4	80-83	FSM-025D	FSD-020		
KZ550	C1-C3	80-82	FSM-025D	FSD-020		
KZ550	D1	81	FSM-025D	FSD-020		
KZ550	H1-H2	82-83	FSM-003T	FSD-019		
ZR550	B2-B5	91-94	FSM-059	FSD-033		
ZX550	A1-A2	84-85	FSM-003T	FSD-017		
KL600	B1-B2	85-86	FSM-026			
ZL600	A1-A2	86-87	FSM-050	FSD-007		
ZL600	B2-B3	96-97	FSM-050	FSD-007		
ZX600	A1-A3	85-87	FSM-050	FSD-007		
ZX600	B1	87	FSM-050	FSD-007		
ZX600	C1-C10	88-97	FSM-032	FSD-039	FSB-015	FRK-916
ZX600	D1-D4	90-93	FSM-047	FSD-009	FSB-010	FRK-910
ZX600	E1-E3	93-95	FSM-047	FSD-009		
ZX600	E1-E12	93-04	FSM-047	FSD-009	FSB-010	FRK-910
ZX600	F1-F3	95-97	FSM-060X	FSD-036	FSB-013	FRK-914
ZX600	G1-G2	98-99	FSM-070D	FSD-042	FSB-009	FRK-909
ZX600	J1-J4	00-05	FSM-070D	FSD-042	FSB-009	FRK-909
ZX600 ZZR600	J	06-08	FSM-070D	FSD-042		
ZX600	K1	03	FSM-060D	FSD-054		
ZX600	M1	04	FSM-060D	FSD-054		
ZX600	N1	05	FSM-047	FSD-009		
ZX600 ZX-6RR	N6F	06	FSM-047	FSD-009		
ZX600 ZX-6R	P	07-08	FSM-047	FSD-009		

MODEL			FSM	FSD	FSB	FRK
ZX600	R	09-10	FSM-047	FSD-009		
ZX636	A1P	02	FSM-070D	FSD-042		
ZX636	B1-B2	03-04	FSM-060D	FSD-054		
ZX636	C1	05	FSM-047	FSD-009		
ZX636 ZX-6R	C6F	06	FSM-047	FSD-009		
EJ650 W650	A1-A2	99-00	FSM-059			
ER650	C	09-10	FSM-060D	FSD-054		
EX650	A	06-08	FSM-060D	FSD-054		
EX650	C	09-10	FSM-060D	FSD-054		
KL650	A1-A19	87-05	FSM-026			
KL650	A6F-A7F	06-07	FSM-026			
KL650	B1-B3	89-91	FSM-026			
KL650	E	08-10	FSM-060X	FSD-028		
KLE650	A	08-09	FSM-047	FSD-009		
KLX650	A1-A3	93-95	FSM-061X	FSD-030	FSB-001	FRK-901
KLX650	C1-C4	93-96	FSM-061X	FSD-030	FSB-001	FRK-901
KLX650	D1	96	FSM-061X	FSD-030	FSB-001	FRK-901
KZ650	B1-B3	77-78	FSM-001			
KZ650	C1-C3	77-79	FSM-001			
KZ650	D1-D2	78-79	FSM-001			
KZ650	E1		FSM-001			
KZ650	F1	80	FSM-001			
KZ650	H1-H3	81-83	FSM-046			
KZ750	B1-B3	76-78	FSM-001			
KZ750	B4	79	FSM-001			
KZ750	E1	80	FSM-046			
KZ750	E2-E3	81-82	FSM-046			
KZ750	F1		FSM-025D			
KZ750	G1		FSM-001			
KZ750	H1-H4	80-83	FSM-046			
KZ750	K1/K2	83-84	FSM-046			
KZ750	L1-L3	81-83	FSM-046			
KZ750	M1		FSM-046			
KZ750	N1/N2	82-83	FSM-025D			
KZ750	R1	82	FSM-046			
VN750	A2-A16	86-00	FSM-057			
VN750	A20-21	04-05	FSM-057			
VN750	A6F	06	FSM-057			
ZR750	C1-C3	91-93	FSM-060X	FSD-036	FSB-013	FRK-914
ZR750	C4	94	FSM-060X	FSD-036		
ZR750 ZR7	F1-F5	99-003	FSM-060D	FSD-054		
ZR750	H1-H3	01-03	FSM-060D	FSD-054		
ZR750	K1	05	FSM-060D	FSD-054		
ZR750	K6F	06	FSM-060D	FSD-054		
ZR750	L	07-10	FSM-060D	FSD-054		
ZX750	A1-A3	83-85	FSM-050	FSD-007		
ZX750	E1-E2	84-85	FSM-050	FSD-007		
ZX750	F1-F3	87-89	FSM-032	FSD-039	FSB-015	FRK-916
ZX750	F4	90	FSM-032	FSD-039		
ZX750	G2	85	FSM-032	FSD-039		
ZX750	H1-H2	89-90	FSM-061	FSD-043	FSB-001	FRK-906
ZX750	J1-J2	91-92	FSM-061	FSD-043		
ZX750	K1-K2	91-92	FSM-045N	FSD-036		FRK-912
ZX750	L1-L3	93-95	FSM-060X	FSD-036	FSB-011	FRK-912
ZX750	M1-M2	93-94	FSM-060X	FSD-036	FSB-011	FRK-912
ZX750	N1/N2	96-97	FSM-061	FSD-043		
ZX750	P1-P8	96-03	FSM-061	FSD-043		
VN800	A1-A11	95-05	FSM-047	FSD-009	FSB-010	FRK-910
VN800	B1-B9	96-05	FSM-047	FSD-009	FSB-010	FRK-910
VN800	C1-C2	99-00	FSM-047	FSD-009		
VN800	E1-E5	01-05	FSM-047	FSD-009		
VN800	E6	06	FSM-047	FSD-009		
VN900	B	07-10	FSM-047	FSD-009		
VN900	C	07-10	FSM-047	FSD-009		
VN900	D	09-10	FSM-047	FSD-009		
KZ900	A4-A5	76-77	FSM-001			
KZ900	B1	76	FSM-001			
Z1 900		73	FSM-003			
Z1A 900		74	FSM-003			
Z1B 900		75	FSM-003			
ZL900	A1/A2	85-86	FSM-057			
ZX900	A1-A3	84-86	FSM-032	FSD-039		
ZX900	B1-B4	94-97	FSM-060X	FSD-036	FSB-011	FRK-912
ZX900	C1-C2	98-99	FSM-070D	FSD-042	FSB-009	FRK-909
ZX900	E1P/E2P	00-01	FSM-070D	FSD-042	FSB-009	FRK-909
ZX900	F1/F2	02-03	FSM-070D	FSD-042		

MODEL			FSM	FSD	FSB	FRK
KZ1000	A1-A4	77-80	FSM-001			
KZ1000	B1-B4	77-80	FSM-001			
KZ1000	C1	78				
KZ1000	D1/D3	78/80	FSM-001			
KZ1000	E1-E2	79-80	FSM-033			
KZ1000	G1	80	FSM-001			
KZ1000	J1-J3	81-83	FSM-032			
KZ1000	K1-K2	81-82	FSM-032			
KZ1000	M1/M2	81-82	FSM-032			
KZ1000	P5-P19	96-00	FSM-032			
KZ1000	R1/R2	82-83	FSM-032			
ZG1000	A1-A8	93	FSM-060X	FSD-036		
ZG1000	A9-A13	94-98	FSM-060X	FSD-036	FSB-013	FRK-914
ZG1000	A14-A20	99-05	FSM-060D	FSD-054		
ZG1000 Z1000	A6F	06	FSM-060D	FSD-054		
ZL1000	A1	87	FSM-057			
ZR1000	A1-A3	03-05	FSM-047	FSD-009		
ZR1000 ZX-10R	A6F	06	FSM-047	FSD-009		
ZR1000 Z1000	B	07-09	FSM-047	FSD-009		
ZR1000 Z1000 ABS	E	10	FSM-047	FSD-009		
ZX1000	B1-B3	88-90	FSM-045N	FSD-036		FRK-914
ZX1000	A1-A2	86-87	FSM-033			
ZX1000	E	09	FSM-061D			
ZX1000 ZX-10R	F	10	FSM-061D			
ZX1000 ZX-10R	C1-C2	04-05	FSM-061D	FSD-046		
KZ1100	A1-A3	81-83	FSM-032			
KZ1100	B1-B2	81-82	FSM-032			
KZ1100	D1/D2	82-83	FSM-032			
KZ1100	L1	83	FSM-032			
ZN1100	B1/B2	84-85	FSM-032	FSD-039		
ZR1100	A1-A3	92-94	FSM-061	FSD-043	FSB-001	FRK-906
ZR1100	C1-C3	97-99	FSM-061D	FSD-046	FSB-007	FRK-907
ZR1100	D1-D4	97-00	FSM-061D	FSD-046	FSB-007	FRK-907
ZX1100	A1-A2	83-84	FSM-050	FSD-007		
ZX1100	C1-C4	90-93	FSM-061	FSD-043	FSB-001	FRK-906
ZX1100	D1-D8	93-00	FSM-061	FSD-043	FSB-001	FRK-906
ZX1100	E1-E3	95	FSM-060X	FSD-036		
ZX1100	F1	96	FSM-060X	FSD-036		
ZR1200	A1P-A3P	01-03	FSM-061D	FSD-046	FSB-007	FRK-907
ZR1200	A4-A5	05	FSM-061D	FSD-046		
ZR1200	B1P-B3P	01-03	FSM-061D	FSD-046	FSB-007	FRK-907
ZR1200	C1P/C2P	01-03	FSM-061D	FSD-046	FSB-007	FRK-907
ZG1200	A1	86-98	FSM-047	FSD-009		
ZG1200	B1-B17	99-03	FSM-047	FSD-009	FSB-010	FRK-910
ZX1200 ZX12R	A1-A4	00-03	FSM-061D	FSD-046		
ZX1200	B1-B4	02-05	FSM-061D	FSD-046		
ZX1200	C1-C4	02-05	FSM-061D	FSD-046		
KZ1300	A1-A4	79-82	FSM-045N			
KZ1300	B2	80	FSM-045N			
ZN1300	A1-A6	83-88	FSM-045N			
ZX1400 ZX-14	A7F	07	FSM-061D	FSD-046		
ZX1400	C	08-10	FSM-061D	FSD-046		
ZX1400 ZZR ABS	D	08-10	FSM-061D	FSD-046		
ZG1400 GTR	C	10	FSM-061D	FSD-046		
ZG1400	D	10	FSM-061D	FSD-046		
VN1500	A1-A12	87-98	FSM-047	FSD-009	FSB-010	FRK-910
VN1500	A6F	06	FSM-061D	FSD-046		
VN1500	B2-B5	88-92	FSM-047	FSD-009	FSB-010	FRK-910
VN1500	C1-C4	94-97	FSM-047	FSD-009		
VN1500	D1-D2	96-97	FSM-047	FSD-009	FSB-010	FRK-910
VN1500	D3	98	FSM-047	FSD-009		
VN1500	E1-E7	98-04	FSM-047	FSD-009	FSB-010	FRK-910
VN1500	G1/G2A	98-99	FSM-047	FSD-009		
VN1500	J1-J2	99-00	FSM-047	FSD-009		
VN1500	L1/L4	00-03	FSM-047	FSD-009		
VN1500	L5	04	FSM-047	FSD-009		
VN1500	N1-N4	00-05	FSM-047	FSD-009	FSB-010	FRK-910
VN1500	N6F-N7F	06	FSM-047	FSD-009	FSB-010	FRK-910
VN1500	P1H-P2H	02-03	FSM-048			
VN1500	RA-R5	01-05	FSM-047	FSD-009		
VN1500	R4	04	FSM-047	FSD-009		
VN1600	A1	03	FSM-061D	FSD-046		
VN1600	A2-A3	04-05	FSM-061D	FSD-046		
VN1600	A6F	06	FSM-061D	FSD-046		
VN1600	B1-B2	04-05	FSM-048			

MODEL			FSM	FSD	FSB	FRK
VN1600	B6F-B7F	06-07	FSM-048X			
VN1600	D1	05	FSM-061D	FSD-046		
VN1600	D	06-08	FSM-061D	FSD-046		
VN2000	A1-A2	04-05	FSM-071XX	FSD-034		
VN2000	A6F-A7F	06-07	FSM-071XX	FSD-034		
VN2000	J/H/G	08	FSM-071XX	FSD-034		
VN2000	G/H	09-10	FSM-071XX	FSD-034		
		SUZUKI				
TS50		74	FSM-009			
RM65	K3-K4	03-04	FSM-004DX	FSD-014		
TS75		75-77	FSM-009			
TM75		74-76	FSM-009			
RM80		89-01	FSM-003T	FSD-038		
RM85		02-06	FSM-044X	FSD-050		
RM85		07-10	FSM-044X	FSD-050		
RM85L		03	FSM-044X	FSD-050		
RV90	K,L,M,A,B	73-77	FSM-009			
RM100		79-81	FSM-003T			
TM100		74-75	FSM-014			
TS100		74-76	FSM-014			
TS100ERT		80	FSM-016			
DR125		82-84	FSM-031			
DR125		86-88	FSM-003T			
DR125SE		94-96	FSM-003T			
GP125		80-84	FSM-009			
GN125E	M-T	91-96	FSM-035			
GS125E	Z,D	82-83	FSM-014			
GS125ES	D,F,K,L,M,N	83-92	FSM-014			
GS125		98-99	FSM-014			
SP125		86-98	FSM-003T			
TS125		74-77	FSM-014			
TS125	C/N	78-79	FSM-016			
RM125		88	FSM-061X			
RM125		89	FSM-070X	FSD-029		
RM125		90	FSM-060X	FSD-028		
RM125		96-00	FSM-71XX	FSD-034		
RM125		01-04	FSM-073XX	FSD-035	FSB-005	FRK-905
RM125		02-03	FSM-073XX	FSD-035		
RM125		04-08	FSM-073XX	FSD-035	FSB-005	FRK-905
RV125		03-10	FSM-076D			
VL125		05-07	FSM-050	FSD-007		
PE175		84-85	FSM-036			
DS185		79	FSM-035			
GT185	M,A,B,C	75-77	FSM-016			
TS185		73-78	FSM-014			
DR200		86-88	FSM-003T	FSD-065		
DR200SE		96-04	FSM-003T	FSD-065		
SP200		86-88	FSM-003T			
AN250	X	99	FSM-060D			
AN250 BURGMAN		03-06	FSM-060D	FSD-045		
DR250	Z-f	82-85	FSM-001			
DR250		90-92	FSM-048			
DR250S	L,M,N,P,R	90-94	FSM-048			
DR250SE	S	93-95	FSM-048			
DR-Z250		01-04	FSM-048			
GT250		73-77	FSM-023			
GN250		82-88	FSM-004D	FSD-016		
GZ250		99-05	FSM-044	FSD-051		
GZ250		06	FSM-044			
GSX250	T,X	80-81	FSM-004	FSD-016N		
GSX250	Z/D	82-83	FSM-004D	FSD-016		
GSX250E	T,X	80-81	FSM-004	FSD-016N		
GSX250F	M/N/P/R	91-94	FSM-027	FSD-066		
GSX250S	Z	82	FSM-004D	FSD-016		
RGV250	K-R	89-94	FSM-047			
RM250		89-90	FSM-060X	FSD-028		
RM250		96-00	FSM-071XX	FSD-034		
RM250		01-03	FSM-069X	FSD-049	FSB-003	FRK-903B
RM250		04-08	FSM-073XX	FSD-035	FSB-005	FRK-905
RM-Z250		04-06	FSM-078	FSD-061	FSB-016	FRK-918
RM-Z250		07-09	FSM-073XX	FSD-035	FSB-005	FRK-905

MODEL			FSM	FSD	FSB	FRK
RM-Z250		10	FSM-073XX	FSD-035		
TS250	B,C	77-78	FSM-003			
TS250ER	N,T,X	79-81	FSM-001			
TS250X	G,H,J	86-88	FSM-026			
TU250	W-X	98-99	FSM-044			
VL250		05-07	FSM-050	FSD-007		
DR350		90-98	FSM-048			
DR350S	L,M,N,P,R	90-94	FSM-048			
DR350SE	R-W	94-98	FSM-048			
DR350SH	N,P,R	92-94	FSM-047			
SP370	C,N	78-79	FSM-046			
GT380		73-77	FSM-023			
AN400 BURGMAN		03-10	FSM-060D	FSD-054		
DR-Z400/E		00-06	FSM-071XX	FSD-034		
DR-Z400S		00-09	FSM-071XX	FSD-034		
DR-Z400SM		05-09	FSM-073XX	FSD-035		
GN400	T	80	FSM-003T			
GN400L	T,X	80-81	FSM-003T			
GN400T	X,Z	81-82	FSM-003T			
GN400TD	T,X	80-81	FSM-003T			
GN400X	T,X	80-81	FSM-003T			
GS400	B/C/N	77-79	FSM-004	FSD-016N		
GS400E	N	79	FSM-004	FSD-016N		
GS400	M/N/P	91-93	FSM-060	FSD-036		
GSF400	M,N,P	91-95	FSM-045N			
GSX400S	T,X	80-81	FSM-004			
GSX400FE	X	81	FSM-004D			
GSX400E	T,X	80-81	FSM-004			
SP400		78-81	FSM-001			
GS425	N	79	FSM-004	FSD-016N		
GS425E	N	79	FSM-004	FSD-016N		
GS450E	T,X,Z,D	80-83	FSM-004	FSD-016N		
GS450GA	Z,D	82-83	FSM-004D	FSD-016		
GS450GAF		85	FSM-004D	FSD-016		
GS450L	T,X,Z	80-82	FSM-004	FSD-016N		
GS450L	D	83	FSM-003T	FSD-019		
GS450L	F,G,H,J	85-88	FSM-003T	FSD-019		
GS450S	T,X	80-81	FSM-004	FSD-016N		
GS450T	X	81	FSM-004D	FSD-016		
GS450TX	Z/D	82-83	FSM-004D	FSD-016		
RM-Z450		05-10	FSM-073XX	FSD-035	FSB-005	FRK-905
DR500	X,Z	81-82	FSM-046			
DR500S	X,Z	81-82	FSM-001			
GS500E	N	79	FSM-003T			
GS500E	K-Y	89-00	FSM-027	FSD-007		
GS500	K1-K3	01-03	FSM-050	FSD-007		
GS500	K4-K5	04-05	FSM-027	FSD-066		
GT500		76-77	FSM-003T			
RG500	G	86	FSM-032			
GS550	B,C	77-78	FSM-003R			
GS550	N-X	79-81	FSM-003T	FSD-019		
GS550D	T	80	FSM-003T			
GS550E	C	78	FSM-003R			
GS550E	N,T/X	79-81	FSM-003T	FSD-019		
GS550E	D,F	83-85	FSM-027			
GS550E	T	80	FSM-003T	FSD-019		
GS550L	N,T,X,Z	79-82	FSM-003T	FSD-019		
GS550L	G	86	FSM-003T			
GS550M	Z	82	FSM-003T	FSD-019		
GS550T	X	81	FSM-003T	FSD-019		
GSX550E	F/G	85-86	FSM-027			
GSX550EU	F/G	85-86	FSM-027			
GSX550ES	F/G	85-86	FSM-027			
GSX550EF	F/G	85-86	FSM-027			
GT550	K,L,M,A,B	73-77	FSM-003R			
DR600S		82-85	FSM-035			
GSF600S BANDIT		95-98	FSM-045N	FSD-036		FRK-914
GSF600S BANDIT	X-K4	99-04	FSM-060D	FSD-045		
GSR600		06-10	FSM-061D	FSD-046		
GSX600F		89-96	FSM-047	FSD-041	FSB-010	FRK-911
GSX600F		97-06	FSM-047	FSD-009		
GSXR600W	N,P	92-93	FSM-047	FSD-041	FSB-012	FRK-913
GSX-R600		97-03	FSM-062	FSD-011		
GSX-R600		04-05	FSM-048X			

MODEL			FSM	FSD	FSB	FRK
GSX-R600		06-10	FSM-047	FSD-009		
RF600R		93-96	FSM-047	FSD-009	FSB-010	FRK-910
AN650 BURGMAN		03-10	FSM-060D	FSD-054		
DL650		04-10	FSM-048X			
DR650REU	R,S	94-95	FSM-060X			
DR650RE	R,S	94-95	FSM-060X			
DR650S	L,M,N,P	90-93	FSM-060X			
DR650SE	R,S	94-95	FSM-060X			
DR650SE		96-05	FSM-036			
GS650G	X-D	81-83	FSM-044			
GS650GT	X/Z	81-82	FSM-044			
GSF650 BANDIT		05-10	FSM-060D	FSD-054		
GSX650F		08-10	FSM-060D	FSD-054		
GR650	D	83	FSM-003T			
GR650X	D,E,F	83-85	FSM-003T			
LS650P	G-Y	86-00	FSM-032			
LS650F	G,J,K	86-89	FSM-032			
SFV650/U GLADIUS		09-10	FSM-047	FSD-009		
SV650	X-K2	99-02	FSM-060D	FSD-045		
SV650	K3-K6	03-06	FSM-047	FSD-009		
SV650	/U/S/SU	07-10	FSM-047	FSD-009		
SV650 ABS	A/UA/SA/SU	07-10	FSM-047	FSD-009		
XF650		97-98	FSM-061			
DR750S	J,K	88-89	FSM-060X			
DR750SU	J,K	88-89	FSM-060X			
GS750	B,C	77-78	FSM-003R	FSD-019		
GS750	N	79	FSM-003T	FSD-019		
GS750D	B,C	77-78	FSM-003R			
GS750D	N	79	FSM-003T	FSD-019		
GS750E	C	78	FSM-003R			
GS750E	N	79	FSM-003T	FSD-019		
GS750L	N/T	79-80	FSM-044			
GS750S	D	83	FSM-027			
GS750T	Z,D	82-83	FSM-003T			
GSX750	T,X	80-81	FSM-003	FSD-019		
GSX750	W/X/Y	98-00	FSM-048	FSD-037		
GSX750E	E	84	FSM-044			
GSX750E	T/X/Z	80-82	FSM-003T	FSD-019		
GSX750EF	E/F	84-85	FSM-044			
GSX750ES	D,E	83-84	FSM-044			
GSX750F	K-T	89-96	FSM-047	FSD-041	FSB-010	FRK-911
GSX750F		97	FSM-047	FSD-009	FSB-010	FRK-910
GSX750F		98-06	FSM-047	FSD-009		
GSX750L	T,X	80-81	FSM-003T	FSD-019		
GSX-R750	G,H	86-87	FSM-045N	FSD-036		
GSX-R750	J,K	88-90	FSM-048	FSD-037	FSB-008	FRK-908
GSX-R750		91-92	FSM-047	FSD-041	FSB-010	FRK-911
GSX-R750		96-03	FSM-048	FSD-037	FSB-014	FRK-915
GSX-R750		04-05	FSM-048X			
GSX-R750		06-10	FSM-047	FSD-009		
GSX-R750W	N/P	92-93	FSM-047	FSD-041	FSB-012	FRK-913
GSX-R750W	R,S	94-95	FSM-048	FSD-037		
VS750GLP	G,H	86-87	FSM-044			
VS750GLP	J,K,L,M	88-91	FSM-037			
VS750GLF	G,H	86-87	FSM-044			
VS750GLF	J,K	88-89	FSM-037			
DR800S/SU	L	90	FSM-045N			
VL800		01-10	FSM-047	FSD-009		
VS800GLP	N-V	92-97	FSM-037			
VS800GL		98-04	FSM-037	FSD-067		
VX800	L,M,N,P,	90-93	FSM-045N	FSD-036		
VX800	R	94	FSM-045N			
VZ800	V-K4	97-04	FSM-045N	FSD-036		
VZ800		05-10	FSM-060D	FSD-054		
GS850G	N-G	79-86	FSM-027			
GS850GL	T,X/D	80-83	FSM-027			
RF900R		94-97	FSM-048	FSD-037	FSB-014	FRK-915
RF900RZ		95	FSM-048	FSD-037		
DL1000		02-10	FSM-048	FSD-037		
GS1000	C /N/T	78-80	FSM-027			
GS1000E	C/N/T	78-80	FSM-027			
GS1000G	T-G	80-86	FSM-027			
GS1000GL	X	81	FSM-027			
GS1000H	C/N/T	78-80	FSM-027			
GS1000L	N	79	FSM-027			

MODEL			FSM	FSD	FSB	FRK
GS1000S	N	79	FSM-027			
GSX-R1000	K1-K4	01-04	FSM-061D	FSD-046		
GSX-R1000	K5-K6	05-06	FSM-061D	FSD-046		
GSX-R1000	K7	07-08	FSM-061D	FSD-046		
SV1000	K3-K4	03-05	FSD-070D	FSD-042		
SV1000S	K3-K4	03	FSD-070D	FSD-042		
TL1000S		97-00	FSM-061	FSD-043	FSB-001	FRK-906
TL1000R		98-03	FSM-061D	FSD-046	FSB-007	FRK-907
GS1100E	T,X,Z	80-82	FSM-027			
GS1100G	E,G	84-86	FSM-027			
GS1100GL	D	83	FSM-027			
GS1100L	T	80	FSM-027			
GSX1100	T/X/Z/D	80-83	FSM-027			
GSX1100E	T/X/Z/D	80-83	FSM-027			
GSX1100E	E,F,G	84-86	FSM-050			
GSX1100EF	E,F,G	84-86	FSM-050			
GSX1100ES	E,F,G	84-86	FSM-050			
GSX1100F		88-93	FSM-047	FSD-041	FSB-010	FRK-911
GSX1100G	M,N,R	91-94	FSM-061	FSD-043	FSB-001	FRK-906
GSX1100L	T	80	FSM-027			
GSX1100S	Z/D	82-83	FSM-027			
GSX-R1100	G,H,J	86-88	FSM-045N	FSD-036		
GSX-R1100	K	89-90	FSM-061	FSD-043	FSB-001	FRK-906
GSX-R1100	M/N	91-92	FSM-045N	FSD-036		FRK-912
GSX-R1100W	P,R	93-94	FSM-060X	FSD-036	FSB-011	FRK-912
GSX-R1100W	S,T,V,W	95-98	FSM-061	FSD-043		
GS1150E	F/G	85-86	FSM-027			
GS1150ES	3/E/F/G	83-85	FSM-027			
GSX1200 X		99	FSM-048	FSD-037		
GV1200GL	F/G	85-86	FSM-045N			
GSF1200SA		96-00	FSM-048	FSD-037	FSB-014	FRK-915
GSF1200S BANDIT		96-00	FSM-048	FSD-037	FSB-014	FRK-915
GSF1200S BANDIT		01-05	FSM-048	FSD-037		
GSF1250		07-10	FSM-048D			
GSX1300R		99-06	FSM-061D	FSD-046		
GSX1300R HAYABUSA		08-10	FSM-061D	FSD-046		
GSX1300B B-KING		08-10	FSM-061D	FSD-046		
GV1400G		85-87	FSM-045N			
GV1400GD		86-87	FSM-045N			
GV1400GT	G/H	86-87	FSM-045N			
GSX1400		02-06	FSM-070D	FSD-042		
VS1400GL(P/F)		87-03	FSM-047	FSD-041		
VS1400GLP		04	FSM-047	FSD-041		
VL1500		98-04	FSM-047	FSD-009		
VL1500		06	FSM-047	FSD-009		
VZ1600		04-05	FSM-048			
VZR1800R		06	FSM-070D	FSM-042		
	YAMAHA					
TY50M		80	FSM-052			
RD50M		82	FSM-009			
DT50M		80	FSM-052			
DT50MX		87	FSM-034			
DT50MX		82	FSM-014			
YZ80		93-01	FSM046X	FSD-027		
RD80MX		81-82	FSM-009			
DT80MX		81-82	FSM-014			
DT80LCII		90	FSM-046			
DT80LCII		85-87	FSM-046			
DT80LC		83-84	FSM-003T			
DT80LC (53V)		85	FSM-025D			
YZ85		02	FSM-046X			
YZ85		03-06	FSM-046	FSD-027		
YZ85LW		03-04	FSM-046	FSD-027		
YZ85		05-09	FSM-046	FSD-027		
DT100		77-83	FSM-009			
MX100		79-83	FSM-009			
RT100		90-92	FSM-009			
RS100DX		79-81	FSM-016			
RS100		75-76	FSM-009			
DT125	A/B/C	74-81	FSM-014			
DT125MX		81	FSM-008			

MODEL			FSM	FSD	FSB	FRK
DT125LC		82	FSM-003T			
DT125R		95-00	FSM-045N			
RD125LC		82	FSM-016			
RD125DX		76-77	FSM-016			
TDR125		96-99	FSM-032	FSD-039		
TTR125		05	FSM-014			
TTR125E		04-06	FSM-014			
TTR125L		06	FSM-014			
TTR125LE		06	FSM-014			
WR125R(KAYABA SHOCK)		09-10	FSM-060D	FSD-054		
WR125X(KAYABA SHOCK)		09-10	FSM-060D	FSD-054		
XV125		99-00	FSM-076D			
XV125		01	FSM-049			
XVS125		02	FSM-049			
XV125S		99	FSM-076D			
YZ125		89-90	FSM-060X	FSD-028		
YZ125		91-95	FSM-061X	FSD-030	FSB-001	FRK-901
YZ125		96-99	FSM-069X	FSD-047X	FSB-003	FRK-903B
YZ125		00-03	FSM-069X	FSD-049	FSB-003	FRK-903B
YZ125		04-10	FSM-078	FSD-061	FSB-016	FRK-918
YP150		01	FSM-064			
DT175MX		78-81	FSM-008			
RD200		78-79	FSM-014			
RD200	A/B/C	74-76	FSM-014			
XT225		05-06	FSM-025D			
DT250	A/B/C/D/E	74-78	FSM-002			
DT250MX		77-78	FSM-002			
DT250MX		80	FSM-001			
RD250LC		80-82	FSM-031			
SR250	G/H/J	80-82	FSM-035			
TDR250		88-90	FSM-026			
TZR250		88	FSM-037			
TTR250		04-06	FSM-061X		FSB-001	
WR250Z		91-97	FSM-061X	FSD-030	FSB-001	FRK-901
WR250F		01-03	FSM-069X	FSD-049	FSB-003	FRK-903B
WR250F		04	FSM-069X	FSD-049		
WR250F		05-10	FSM-078	FSD-061	FSB-016	FRK-918
WR250FP		02	FSM-069X	FSD-049	FSB-003	FRK-903B
XG250 TRICKER		05	FSM-049			
XV250		05-06	FSM-076D			
YP250		96-99	FSM-076D			
YZ250		89-90	FSM-060X	FSD-028		
YZ250		91-95	FSM-061X	FSD-030	FSB-001	FRK-901
YZ250		96-00	FSM-069X	FSD-047X	FSB-003	FRK-903B
YZ250		01-03	FSM-069X	FSD-049	FSB-003	FRK-903B
YZ250		04-07	FSM-078	FSD-061	FSB-016	FRK-918
YZ250F		00-03	FSM-069X	FSD-049	FSB-003	FRK-903B
YZ250F		04-09	FSM-078	FSD-061	FSB-016	FRK-918
XT350N		86-90	FSM-001			
XT350		91-92	FSM-001			
RD350		75	FSM-002			
RD350LC		80-82	FSM-031			
RD350LC YPVS		83-84	FSM-003T	FSD-002		
RD350LCF		85	FSM-003T	FSD-002		
RD350LC N		86-90	FSM-003T			
RD350LC H		86-90	FSM-003T			
XS360	C/D	76-77	FSM-004			
DT400	B/C/D/E	75-78	FSM-002			
DT400MX		77-79	FSM-002			
FZR400R		88-90	FSM-032	FSD-039		
RD400,S		76	FSM-002			
RD400		78-79	FSM-003			
WR400F		99-00	FSM-069X	FSD-047X	FSB-003	FRK-903B
WR400F		01-02	FSM-069X	FSD-049	FSB-003	FRK-903B
XS400	D/E/F/G/H	77-81	FSM-004			
XS400	(2A2)	81-82	FSM-004			
XS400	J/K	82-83	FSM-003T	FSD-002		
XS400S	G/H	80-81	FSM-004			
XS400S	J	82	FSM-004			
XS400 DOHC		82-87	FSM-003T			
XS400R SECA	J/K	82-83	FSM-003T	FSD-002		
XS400SE		81-82	FSM-004			
YP400 MAJESTY		04-10	FSM-060D	FSD-054		
YZ400		98-99	FSM-069X	FSD-047X	FSB-003	FRK-903B

MODEL			FSM	FSD	FSB	FRK
WR426FN		01	FSM-069X	FSD-049	FSB-003	FRK-903B
WR426F		02	FSM-069X	FSD-049	FSB-003	FRK-903B
WR426FP		02	FSM-069X	FSD-049	FSB-003	FRK-903B
YZ426F		01-03	FSM-069X	FSD-049	FSB-003	FRK-903B
YZ450F		04-09	FSM-078	FSD-061	FSB-016	FRK-918
WR450F		03-04	FSM-069X	FSD-049		
WR450F		05-10	FSM-078	FSD-061	FSB-016	FRK-918
WR450FR		03	FSM-069X	FSD-049		
RD500LC		84-85	FSM-027			
SR500		78-93	FSM-003			
TX500/A		73-74	FSM-002			
WR500Z		92-93	FSM-061X	FSD-030	FSB-001	FRK-903B
XP500 T-MAX /ABS		08-09	FSM-061D	FSD-046		
XS500		76-78	FSM-003T			
XS500	B/C/D/E	75	FSM-002			
XT500		78-88	FSM-001			
XV500		83	FSM-046			
XV535		87-00	FSM-025	FSD-032		
XV535S		94-98	FSM-025	FSD-032		
XV535SE,N		88	FSM-025	FSD-032		
XJ550		81-82	FSM-049			
XJ550		83	FSM-049			
XJ550R	H/J/K	81-83	FSM-049			
XT550	J/K	82-83	FSM-032			
XT550		82-83	FSM-026			
XZ550R	J/K	82-83	FSM-049			
FJ600	L/N	84-85	FSM-046			
FZ600	S/T/U	86-88	FSM-046			
FZR600		89-92	FSM-032	FSD-039	FSB-015	FRK-916
FZR600		93	FSM-032	FSD-039	FSB-015	FRK-916
FZR600R		94-95	FSM-060X	FSD-036		
FZR600R		96-97	FSM-032	FSD-039	FSB-015	FRK-916
FZR600R		98-99	FSM-032D			
FZS600		98-03	FSM-060D	FSD-054		
FZS600S		01	FSM-060D	FSD-054		
FZS600P		02	FSM-060D	FSD-054		
FZS600SN		01	FSM-060D	FSD-054		
FZS600R		03	FSM-060D	FSD-054		
FZ6 FAZER		04-07	FSM-075			
FZ6-N		04-06	FSM-075			
FZ6-NS		05-06	FSM-075			
FZ6-S FAZER		06	FSM-075			
FZ6-SA FAZER		06	FSM-075			
FZ6-SHG FAZER		07	FSM-075			
FZ6 FAZER ABS		06-07	FSM-075			
FZ6 S2		07-08	FSM-075			
FZ6 S2 FAZER		07-08	FSM-075			
FZ6 S2 FAZER ABS		08	FSM-075			
R46 600		06	FSM-060D	FSD-054		
SRX600H,N		86	FSM-046			
XJ600		84-88	FSM-046			
XJ600N		00-02	FSM-060D	FSD-054		
XJ600S		92-97	FSM-032	FSD-039	FSB-015	FRK-916
XJ600S		98-99	FSM-060D	FSD-054		
XT600		84-89	FSM-041			
XT600EH/EN		90-93	FSM-041			
XT600E	A/B/D/E/F	90-94	FSM-041			
XT600E		95-02	FSM-045N			
XT600H,N		86-90	FSM-041			
XT600Z		83-90	FSM-047			
YZF600R		95-98	FSM-060X	FSD-036		
YZF600R		99-05	FSM-060X	FSD-036	FSB-013	FRK-914
YZF600R		06	FSM-060D	FSD-054		
YZF-R6		99-04	FSM-061D	FSD-046		
YZF-R6		05	FSM-060D	FSD-054		
YZF-R6P		02	FSM-061D	FSD-046		
YZF-R6S		01	FSM-061D	FSD-046		
YZF-R6S		08	FSM-061D	FSD-046		
TX650	A	74	FSM-002			
XJ650	G/H/J/K	80-83	FSM-046			
XJ650L	J/H	81-82	FSM-046			
XJ650L	K	83	FSM-027			
XJ650R	J	82	FSM-046			
XS650	B/C	75-76	FSM-002			
XS650	D/E/F/G/H	77-81	FSM-003			
XS650S	E/F/G/H/J/K	78-83	FSM-003			
XS650SE		80-81	FSM-003			
XVS650		97-98	FSM-060X	FSD-036	FSB-013	FRK-914

MODEL			FSM	FSD	FSB	FRK
XVS650		99-06	FSM-060D	FSD-054		
XVS650A		99-08	FSM-060D	FSD-054		
XVS650AT		06-08	FSM-060D	FSD-054		
MT-03		06-09	FSM-061X	FSD-030		
XTZ660H,N		92-93	FSM-036			
XTZ660		91	FSM-036			
XT660R		04-09	FSM-061X			
XT660Z TENERE		08-09	FSM-061X	FSD-030		
XT660X		08-10	FSM-061X			
XJ700X	N/C	85-86	FSM-032			
XJ700	N/S	85-86	FSM-032			
TX750		73-74	FSM-003			
FZ750		85-90	FSM-059			
FZR750	T/U	87/88	FSM-045N	FSD-036		
FZR750R		90	FSM-061	FSD-043		
XJ750	J/K	82-83	FSM-046			
XJ750		84	FSM-027			
XJ750M	K	83	FSM-046			
XJ750R	H/J/K	81-83	FSM-025D			
XJ750R	N	85	FSM-027			
XS750	D	77	FSM-003T			
XS750	E/F	78-79	FSM-025	FSD-020		
XS750SE		78-79	FSM-025	FSD-020		
XS750S	E/F	78-79	FSM-025	FSD-020		
XTZ750		89	FSM-036			
XTZ750		91-95	FSM-036			
XTZ750H		90	FSM-036			
XV750	H/J/K	81-83	FSM-046			
XV750		88-94	FSM-032			
XV750		95-97	FSM-032	FSD-039	FSB-015	FRK-916
XV750M	K	83	FSM-046			
XV750SE		81-82	FSM-046			
YZF750R		94	FSM-060X	FSD-036	FSB-011	FRK-912
YZF750R		96-98	FSM-060X	FSD-036	FSB-013	FRK-914
YZF-R7		99	FSM-075			
FZ8 N		11	FSM-061D	FSD-046		
FZ8 S		11	FSM-061D	FSD-046		
TDM850		94-95	FSM-061			
TDM850		96-99	FSM-075			
TRX850		96	FSM-060X	FSD-036		
TRX850		98	FSM-060D			
XS850	G/H	80-81	FSM-025	FSD-020		
XS850L	G/H	80-81	FSM-046			
XS850S	G/H	80-81	FSM-046			
TDM900		02-09	FSM-061D	FSD-046		
TDM900R		03-05	FSM-061D	FSD-046		
XJ900		83	FSM-027			
XJ900		84-85	FSM-050			
XJ900R	K	83	FSM-027	FSD-007		
XJ900R		85	FSM-050			
XJ900S		95-97	FSM-060X	FSD-036		
XJ900S		98-02	FSM-060D	FSD-054		
XJ900SP		02	FSM-060D	FSD-054		
XV920	J	82	FSM-025D			
XV920		83	FSM-046			
XV920M		83	FSM-046			
XV920RJ		82	FSM-027			
XV920RH		81	FSM-050			
XVS950A MID NIGHT STAR		09-10	FSM-060D	FSD-054		
FJ1100	"47E"	84-85	FSM-045N	FSD-036		
FZR1000		87-88	FSM-045N	FSD-036		FRK-914
FZR1000		89-90	FSM-061	FSD-043	FSB-001	FRK-906
FZR1000		91-93	FSM-045N	FSD-036		FRK-912
FZR1000		94-95	FSM-061			
FZS1000 FAZER		01-03	FSM-075			
FZS1000 FAZER		04-05	FSM-075			
FZ1		08-09	FSM-061D	FSD-046		
FZ1 FAZER		08-10	FSM-061D	FSD-046		
FZ1-N		06	FSM-061D	FSD-046		
FZ1-S FAZER		06	FSM-061D	FSD-046		
FZ1-SA FAZER		07	FSM-061D	FSD-046		
FZS10		08	FSM-061D	FSD-046		
XV1000		81-82	FSM-027			

MODEL			FSM	FSD	FSB	FRK
XV1000	L/N	84-85	FSM-032			
XV1000SE		83	FSM-025D			
XV1000SE		86-88	FSM-032			
YZF R1		98-01	FSM-060D	FSD-054		
YZF-R1		02-08	FSM-061D	FSD-046		
YZF-R1		09-10	FSM-075			
BT1100 BULLDOG		03-06	FSM-061D	FSD-046		
XS1100	E/F/G/H	78-81	FSM-027			
XS1100S	F/G/H	79-81	FSM-007			
XV1100		86-93	FSM-032			
XV1100		94-97	FSM-032	FSD-039	FSB-015	FRK-916
XVS1100		99-06	FSM-060D	FSD-054		
XVS11		08	FSM-060D	FSD-054		
XVS1100A		01-03	FSM-060D	FSD-054		
XVS1100AT		06	FSM-060D	FSD-054		
XVS1100AW		06	FSM-060D	FSD-054		
FJ1200	S/T/W/A	86-90	FSM-045N	FSD-036		
FJ1200	B/D	91-92	FSM-060X	FSD-036		
FJ1200A	D/E	92-93	FSM-060X	FSD-036		
FJR1200A		10				
XVZ12T	K	83	FSM-033			
XVZ12	L	84	FSM-033			
XVZ12D	L/N	84-85	FSM-033			
XTX1200		10	FSM-061X	FSD-030		
VMX12		85-92	FSM-033			
VMX12		93-98	FSM-061	FSD-043	FSB-001	FRK-906
VMX12		99-01	FSM-061D	FSD-046	FSB-007	FRK-907
VMX12		02-06	FSM-061D	FSD-046		
XJR1300		99-03	FSM-061D	FSD-046		
XJR1300		04-09	FSM-061D	FSD-046		
XJR1300SP		99-03	FSM-061D	FSD-046		
XVS1300		07-08	FSM-060D	FSD-054		
XVS13A		08	FSM-060D	FSD-054		
XVZ13	T/U	87-88	FSM-033			
XVZ13CT		06-08	FSM-048	FSD-037		
XVZ13CTM		06	FSM-048	FSD-037		
XVZ13D	S-E	86-93	FSM-033			
XVZ13LT		97-01	FSM-048	FSD-037		
XVZ13A		96-97	FSM-048	FSD-037		
XVZ13AT		96-97	FSM-048	FSD-037		
XVZ1300A		00	FSM-048	FSD-037		
XVZ13TF		00-06	FSM-048	FSD-037		
XVZ13TFM		04-06	FSM-048	FSD-037		
XVZ1300A		00	FSM-048	FSD-037		
XV1600A		99-02	FSM-048	FSD-037		
XV1600AT		01	FSM-048	FSD-037		
XV1600AL		00	FSM-048	FSD-037		
XV1600AS		01	FSM-048	FSD-037		
XV1700PCP/PCR		02-03	FSM-060D			
XV17PCM		08	FSM-060D	FSD-054		
XV17A		04-05	FSM-048	FSD-037		
XV17AT		04-05	FSM-048	FSD-037		
XV1700AM		04	FSM-048	FSD-037		
MT01		05-09	FSM-075			
			DUCATI			
748 BIPOSTO		98	FSM-048			
748 STRADA		98	FSM-048			
748 BIPOSTO		95-97	FSM-048			
748 SP		95-97	FSM-048			
750 SS		94	FSM-047			
851 BIPOSTO		90	FSM-047			
851 SP2		88	FSM-047			
851 SPORT		88	FSM-047			
888 SP5		92-94	FSM-047			
888 STRADA		91-94	FSM-047			
900 M		93-98	FSM-047			
900M CHROMO		98	FSM-047			
900 SL		92-98	FSM-047			
900 SS		90-97	FSM-047			
907 IE		91-94	FSM-047			
916 BIPOSTO		95-97	FSM-048			
916 SENNA		95-97	FSM-048			
916 SP		94-97	FSM-048			
916 SPS		97-98	FSM-048			
916 STRADA		94-95	FSM-048			
916		98	FSM-048			
916 SENNA		98	FSM-048			

MODEL			FSM	FSD	FSB	FRK
944 ST2		97-98	FSM-048			
		GUZZI				
V65 FLORIDA		86-93	FSM-026			
V65 GT		87-94	FSM-026			
750 NEVADA		91-93	FSM-026			
750 NEVADA N.T.		94-98	FSM-026			
750 STRADA		93-96	FSM-026			
750 TARGA		90-93	FSM-026			
750 V75		85-87	FSM-026			
		TRIUMPH				
DAYTONA 750		93-98	FSM-036			
TRIDENT 750		91-97	FSM-036			
ADVENTURE 900		96-97	FSM-036			
DAYTONA 900		93-98	FSM-036			
DAYTONA 900 SPIII		94-98	FSM-036			
SPEEDO TRIPLE 900			FSM-036			
SPRINT 900		92-98	FSM-036			
THUNDERBIRD 900		95-98	FSM-036			
TIGER 900		93-98	FSM-036			
TRIDENT 900		91-97	FSM-036			
TROPHY 900		91-98	FSM-036			
DAYTONA 1200		93-98	FSM-036			
TROPHY 1200		91-98	FSM-036			

REMARKS:

REMARKS: FSM-059D/FSD-019 ... NO LONGER AVAILABLE

FSM-077 IS NO LONGER AVAILABLE

FSD-049 BECOME NO LONGER AVAILABLE

USE FSD-047X instead of FSD-049

FRK-903 BECOME NO LONGER AVAILABLE

USE FRK-903B instead of FRK-903

STEERING OIL DAMPERS

The item marked with "TUV" has passed the TUV test and supplied with technical data.
ODM3000/2000 have hard anodized aluminum body.

7 position click adjustment for every riding condition
Rod dia. Is 10 m/m for all dampers.

ODM3000ER SEREIS



COLOR GOLD

Stock No	Stroke	Body	Total length	Mounting bracket
ODM3090ER-S	90 m/m	175 m/m	315 m/m	ER
ODM3110ER	110 m/m	200 m/m	355 m/m	ER
ODM3000ER	130 m/m	215 m/m	395 m/m	ER
ODM3160ER	165 m/m	265 m/m	485 m/m	ER
ODM3190ER	190 m/m	290 m/m	535 m/m	ER

<ER BRACKET>



ODM3000E SERIES



COLOR GOLD

Stock No	Stroke	Body	Total length	Mounting bracket
ODM3090E	90 m/m	175 m/m	315 m/m	E TUV
ODM3110E	110 m/m	200 m/m	355 m/m	E TUV
ODM3000E	130 m/m	215 m/m	395 m/m	E TUV
ODM3160E	165 m/m	265 m/m	485 m/m	E
ODM3190E	190 m/m	290 m/m	535 m/m	E

<E BRACKET5>



ODM3000-XS



HARD ANODIZED ALUMINUM BODY
WEIGHT 360 g
COLOR GOLD

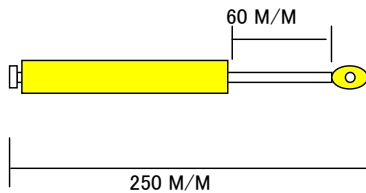

ODM2000

TUV



ANODIZED ALUMINUM BODY
WEIGHT 450 g
COLOR GUNMETAL

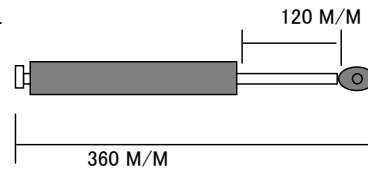

ODM1000 **TUV**



HARD CHROME PLATED FINISH

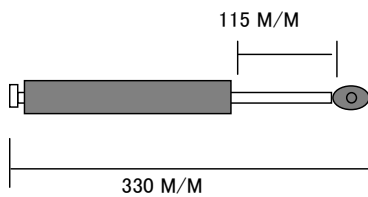

ODM500 **TUV**



BLACK

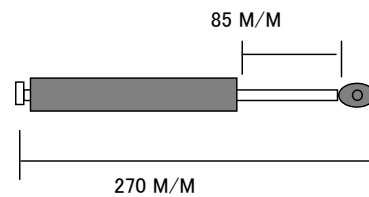

FITTING KIT

WITHOUT MOUNGINT BRACKET

	500	1000	2000	3000-XS	3000E	3000	3090E	3110E	3110ER	3160ER	3160E
HONDA											
NSR50/80'88-	12130N						12130N				
NS-1	12131N						12131N				
MONKEY 6V/12V	12100N						12100N				
MONKEY R '87-	12103N						12103N				
CB50J/JX	12105N										
CB750F/900F/1100F					16115N						
VFR750R(RC30)'87			12140N		12140N		STEERING STOP need to be modified				
VFR400R(NC30)			12134N								
CB1000SF											16125N
CB1300S/F'98										16117N	
CB600F HORNET '98			14116N		14116N						
CBR600F'99-00				BRK-6101							
VTR1000'97-									16109N		
KAWASAKI											
W650'99-	12201N						16213N				
GPZ600R'85-					16279N						
ZXR750 '89-90		12294N	12294N		12294N						
ZXR750R'91-94		12297N	12297N		12297N						
Z1000 J/R Z1R		12278N	12278N		12278N						
GPZ400F/FZ Z400GP			12287N		12287N						
ZRX400'94			12263N		12263N						
ZR750'91- ZEPHYR			12280N		12280N						
Z1000MK2 Z-1			12239N		12239N		*RECTIFIER NEED TO BE MODIFIED (Z1000MK2)				
GPZ900R/750R A1-A6							16296N				
GPZ900/750R(A7-)							16295N				
GPZ1000RX '86-87										16224N	
ZX10 '88-89										16220N	
ZRX1100'97-(W/CAWLING)									16205N		
ZR1100					16214N						
ZZR1100'90-92										16219N	
ZR-7 '99-			14216N		14216N						
SUZUKI											
GSX750S/110S KATANA							16316N				
GSX-R1100'87-88 GSX-R750'87							16321N				
GSX-R750'88-89		12366N	12366N		12366N		*NEED TO BE MODIFIED (STEERING STOP)				
BANDIT GSF250/400'89-94			12370N		12370N						
BANDIT GSF250/400'95-			12301N		12301N						
GSX-R750'90-91 GSX1100'89-92										16317N	
GSX-R750'00				BRK-6302							
GSF1200'95-			12300N					12300N			
TL1000S'97-				BRK-6303							
TL1000R'98-00				BRK-6301							
GSX1200 INAZUMA'98										16304N	
GSX1300R HAYABUSA'00				16306N							
YAMAHA											
SR400/500'78		12456N	12456N		12456N						
SRX600'85-89		12455N	12455N		12455N						
TZR250'86-88			12455N		12455N						
FZX750'86-			12400N					12400N			
XJR1200'94-			12464N					12464N			
YZF1000 R1						16403N	*Part of carbon panel to be cut-off				

BRK-6101 & ODM3000-XS



BRK-6302 & ODM3000-XS



ODM3000 & 16403N



FORK TUBE BRACKET

<BRK>

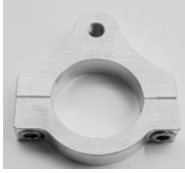

BRK	DIA
BRK-27	27M/M
BRK-30	30M/M
BRK-31	31M/M
BRK-32	32M/M
BRK-33	33M/M
BRK-35	35M/M
BRK-36	36M/M
BRK-37	37M/M
BRK-38	38M/M
BRK-39	39M/M
BRK-40	40M/M
BRK-41	41M/M
BRK-43	43M/M
BRK-45	45M/M
BRK-50	50M/M
BRK-51	51M/M
BRK-52	52M/M
BRK-54	54M/M

<BRE>



BRE	DIA.
BRE-41	41M/M
BRE-43	43M/M
BRE-50	50M/M
BRE-51	51M/M
BRE-52	52M/M

CAM SHAFT TIMING CHAINS



MODEL	STOCK NO	
GRF50F	05-06	CMM-U082
GRF70F	04-06	CMM-U082
GRF100F	04-09	CMM-R090
XL100S	79-85	CMM-R090
XR100R	93-03	CMM-R090
CB125T/T2/TA	79	CMM-RD094
CB125TDC	82	CMM-RD094
GLR125	98-00	CMM-Y100
GM125CH	87	CMM-RD094
SH125	01-07	CMM-Y094
VT125 SHADOW	99-00	CMM-Y100
XL125RC	82	CMM-R098
XL125S	85	CMM-R098
XL125V	01-05	CMM-Y100
CRF150R	07-09	CMM-E096
CRF150F	09	CMM-Y094
SH150	01-07	CMM-Y094
XL185S	79-83	CMM-T100
XL185S	87-93	CMM-T100
XL200R	83-84	CMM-T100
XR200	80-84	CMM-T100
XR200R	81-83	CMM-T100
XR200R	84-85	CMM-A100
XR200R	86-02	CMM-T100
CRF230F	09	CMM-Y104
CB250	08	CMM-098
CB250 TWO FIFTY	93-97	CMM-A098
CB250N	92-93	CMM-A098
CB250N/NA/NB/NDB/NDC	79-83	CMM-A108
CB250N/NA/NB/NDC/NC	79-85	CMM-A110
CB250RSA/RSD/RSDC	80-84	CMM-A104
CB250T	78-80	CMM-A108
CBX250RSE	84-86	CMM-A108
CL250Sc	82	CMM-A104
CM250C	82-83	CMM-A098
CM250TR	82-84	CMM-A108
CMX250	08-09	CMM-098
GMX250C	85-87	CMM-A098
GMX250CD	86	CMM-A098
GN250	86-97	CMM-M098
FES 250 FORESIGHT	98-05	CMM-M098
NSS250EX FORZA	05-07	CMM-Y098
NSS250X	05-07	CMM-Y098
CRF250R	05-09	CMM-E104
CRF250R	10	CMM-E106
CRF250X	04-05	CMM-E104
NX250J/K/L	88-90	CMM-B126
VT250C	95	CMM-J128
XL250S/SA/SB/RC	79-83	CMM-A104
XL250RE/RF/RH	84-87	CMM-A102
XR250L	91-96	CMM-A102
XR250Z/A/SZ/SA/SB	79-81	CMM-A104
XR250R	81-82	CMM-A104
XR250R	84-95	CMM-A102
XR250R	96-04	CMM-B102
XL350RD/RE	83-84	CMM-A108
XL350RJ	88	CMM-A108
CB400A	78-79	CMM-A110
CB400T HAWK	78-80	CMM-A110
CB400Tz	79	CMM-A110
GM400A	79-81	CMM-A110
GM400E	80-81	CMM-A110
GM400T(Z/A/B/C)	79-82	CMM-A110
XR400R	96-04	CMM-B112
CB450K3-K7		CMM-Q128
CB450S	86-88	CMM-A110
CB450N	85	CMM-A110
CB450DXK	89-92	CMM-A110
GRF450R	02-08	CMM-E112
CRF450R	09-10	CMM-EX108
FJS400D SILVERWING	03-07	CMM-J138
CB500K/K1/K2 500 FOUR		CMM-Q088
CB500T76 TWIN DOHC	76	CMM-Q128
CB500	96-00	CMM-B130
CB500S	98-00	CMM-B130
CBF500	04	CMM-B130
GX500/Z	78-79	CMM-P078
GX500 A/B	80-81	CMM-P078
GX500C A/B/C	80-82	CMM-P078
CX500TC C	82	CMM-P078
CX500D A	80	CMM-P078
FT500C	82-84	CMM-A120
GL500B/IB	81	CMM-P078
GL500C/IG/DC	82	CMM-P078
NX500S	95	CMM-J118
VF500F E/2E/F	84-85	CMM-TD130
VT500C	83-85	CMM-A116
VT500ED/EF	83-85	CMM-A116
VT500FT	83-84	CMM-A116
XBR500F/G/H/SH	85-87	CMM-A118
XL500R	82	CMM-A120
XL500S/SZ/SA/SB	79-81	CMM-A120
XR500	83-84	CMM-A118
XR500SZ/SA/SB	79-81	CMM-A120
XR500RD/RE	83-84	CMM-A118
CB550K/K1 550 FOUR	76	CMM-Q088
CB550F	76-77	CMM-Q088
CB550K	77-78	CMM-Q088
CB550SC	83	CMM-A140

MODEL	STOCK NO	
CBX550FC/F2C/FD/F2D	82-83	CMM-A134
CB800F	98-10	CMM-E116
CB800FA	07-10	CMM-E116
CB800F2	00	CMM-E116
CBF800N/NA	04-09	CMM-E116
CBF800S/SA	04-09	CMM-E116
CBR600 F4	99-04	CMM-E116
CBR600F	87-90	CMM-A126
CBR600F	91-05	CMM-E116
CBR600FR	02	CMM-E116
CBR600FS	01-02	CMM-E116
CBR600RR	03-04	CMM-E116
CBR600RR	08-10	CMM-E116
FJS800 SILVERWING	01-02	CMM-J138
FJS800A SILVERWING	03-07	CMM-J138
NTV600J/K/L/M	88-92	CMM-B118
VT600C SHADOW	88-04	CMM-B118
VT600CD SHADOW D.	95-04	CMM-B118
VT600CD2	99	CMM-B118
XL600L D	83	CMM-A118
XL600LMF/LMH	85-87	CMM-A118
XL600R D/E/F/G	83-86	CMM-A118
XL600V H/J TRANSALP	86-87	CMM-A118
XL600V J-P	88-93	CMM-B118
XL600V TRANSALP	00	CMM-J118
XR600R F/G	85-86	CMM-A118
XR600R	88-00	CMM-B118
CB850Z	79	CMM-A112
CB850A/B	79-81	CMM-A112
CB850	80-82	CMM-A112
CB850C	80-81	CMM-A112
CB850SC NIGHTHAWK	82	CMM-A112
CB850SC	83-85	CMM-A144
CBX850ED/SCD	83	CMM-A144
CX850C	83	CMM-P078
CX850E D	83	CMM-P078
CX850T	83	CMM-P078
GL850L D	83	CMM-P078
GL850D D/2D	83	CMM-P078
NT650	89-91	CMM-B118
NT650V	98-00	CMM-B118
NT650V	05	CMM-J118
NTV650J	88	CMM-B118
NTV650P REVERSE	93	CMM-B118
NX650J/K/L/M/N/P/R	88-94	CMM-B118
NX650	95-97	CMM-J118
XL650V	00-04	CMM-J118
XR650J/K	88-89	CMM-B118
XR650L	93-09	CMM-B118
XR650R	00-05	CMM-J122
XR650R	07	CMM-J122
CB750C	80-82	CMM-A124
CB750K Z	79	CMM-A124
CB750F A/B/C/2C	80-82	CMM-A082
CB750F2	92-01	CMM-A148
CBX750FE/FG/G2G	84-86	CMM-A148
NT700V	06-10	CMM-J118
NT700VA	06-10	CMM-J118
NV750C2	99	CMM-B118
VF750SC/SD SABRE	82-83	CMM-A148
VF750FD/FE/FF	83-85	CMM-A148
VF750C MAGNA	82-84	CMM-A148
VF750C	93-00	CMM-E128
VF750C2	97-00	CMM-E128
VF750CD	95-96	CMM-E128
VT750C	83-85	CMM-A128
VT750C	97-99	CMM-B118
VT750C	01-05	CMM-J118
VT750C	07-09	CMM-J118
VT750CA	07	CMM-J118
VT750C2	97-99	CMM-B118
VT750C2	01	CMM-J118
VT750C3	01	CMM-J118
VT750CD	98-99	CMM-B118
VT750CD2	98-99	CMM-B118
VT750DC	01-02	CMM-J118
VT750DCA/DCB	03	CMM-J118
VN750A8-A8 VULCAN	90-92	CMM-A082
XR750RL/RM/RN/RP	90-00	CMM-B118
XLV750R	83	CMM-A128
VT800C SHADOW	88	CMM-A128
PC800	89-98	CMM-A128
CB900FZ	79	CMM-A126
CB900F D/2D	83	CMM-A082
CB900F A/B/2B/C/2C	80-82	CMM-A126
CB900F HORNET	02-03	CMM-E126
CB900F	07	CMM-E126
CBR900RR	92-99	CMM-E126
CBR900RR	00-03	CMM-E124
CBR900RE	01	CMM-E124
CB1000R	09	CMM-E126
CB1000RA	09	CMM-E126

MODEL	STOCK NO	
CBF1000	06-10	CMM-E126
CBF1000A	06-10	CMM-E126
CBR1000F	87-96	CMM-A150
CBR1000RR	04-07	CMM-E126
GL1000K3/Z		CMM-BELT1
GL1000K1/K2/LTD		CMM-BELT1
VF1000FE/FF/FG	84-86	CMM-A122
VF1000F2/F2G BOLD'OR	85-86	CMM-A122
VTR1000F	97-07	CMM-K152
XL1000V	99-05	CMM-K152
CB1100RB/RC/RD	81-83	CMM-A126
CB1100FD	83	CMM-A126
CB1100SF	00	CMM-E130
CBR1000RR	09	CMM-K124
CBX1000Z/B/C	79-82	CMM-A120
CBR1100XX	97-04	CMM-E130
GL1100A/IA/DA	80	CMM-BELT1
GL1100B/IB/DB	81	CMM-BELT1
GL1100C/IC/DC/AC	82	CMM-BELT1
GL1100D/ID/DD/AD	83	CMM-BELT1
VT1100C SHADOW	85-04	CMM-A136
VT1100C2	95-05	CMM-A136
VT1100C3	98-00	CMM-A136
VT1100D2	99	CMM-A136
VT1100T	98-00	CMM-A136
VF1100CD/CE/CF/CG	84-87	CMM-A154
CB1300	05-09	CMM-E146
CB1300A	05-09	CMM-E146
CB1300S	05-09	CMM-E146
VTX1300S	03-07	CMM-E140
VTX1300 C	09	CMM-E140
ST1300A	08	CMM-J138
ST1300	09	CMM-J138
GL1800	01-08	CMM-J118
GL1800A	01-02	CMM-J118
VTX1800C	02-04	CMM-E148
		KAWASAKI
125 ELIMINATOR	99-00	CMM-J102
BN125A8	05	CMM-J102
BN125A7F	07	CMM-J102
Z200A1-A3	78-80	CMM-W090
BJ250A2-A3	94-95	CMM-B122
BJ250C2	96-97	CMM-B122
EL250B2-B3	88-89	CMM-B124
EL250D4-D5	93-94	CMM-B124
EL250E1-E3	91-93	CMM-B124
EL250F6	03	CMM-B124
EX250E1/E2	86-87	CMM-B124
EX250F2-F19	88-05	CMM-B124
EX250F6-F7	06-07	CMM-B124
EX250H1-H14	90-03	CMM-B124
EX250K	08-10	CMM-FF124
KL250A1-A5	78-82	CMM-W090
KL250C1/C2	83-84	CMM-W090
KL250D2-D22	85-05	CMM-B158
KL250G4-G6	00-02	CMM-J122
KLX250A1/A2	79-80	CMM-W090
KLX250D1-D4	93-96	CMM-J128
KLX250E1-E3	93-95	CMM-J128
KLX250H6F	06	CMM-J128
KLX250S	09-10	CMM-J128
KX250F	04-05	CMM-J114
KX250F	06-10	CMM-J114
KZ250D1/D2	80-81	CMM-W090
KZ250L1	82	CMM-W090
KZ250W1	83	CMM-W090
KLX300A2-A10	97-05	CMM-J128
KLX300A6F	06	CMM-J128
KZ305A1/A2	81-82	CMM-B082
KZ305B1-B3	82-84	CMM-G082
EX305B1 GPZ	83	CMM-A102
KZ400A1-A2 LTD	80-81	CMM-A114
KZ400A3-A4 LTD	82-83	CMM-A114
Z400B2-B4	80-82	CMM-A140
KZ400C1	78	CMM-W088
KZ400/D	74-75	CMM-W088
KZ400H1	79	CMM-W088
Z400J1-J3	80-83	CMM-A140
ZR400A1/B1	83-85	CMM-A140
ZX400L1-L3 ZXR400	91-93	CMM-B118
Z440A1-A3	80-82	CMM-A114
KZ440B1/B2	80-81	CMM-A114
KZ440D2-D5 LTD BELT	80-83	CMM-A114
KZ440G1 BELT	82	CMM-A114
EN450A1-A5	86-90	CMM-A148
KLX450A	08-10	CMM-FF124
KX450F D	06-08	CMM-FF122
KX450F	09-10	CMM-FF122
EN500A1-A4 VULCAN	90-96	CMM-A148
EN500C1-C9	96-04	CMM-A148
EN500 C6F-C7F	06-07	CMM-A148
EN500 D	07-08	CMM-A148
ER500A1-A3	97-99	CMM-A148
ER500C1/C2	01-03	CMM-A148

MODEL	STOCK NO	
GS1000GE/GF/GG	84-86	CMM-G120
GS1000C/EN/EC/N/HN	78-82	CMM-G120
GSX-R1000	01-09	CMM-A130
GSX1100SZ/SD KATANA	82-83	CMM-G120
GSX1100LT	80	CMM-G120
GSX1100G M/N/P/R	91-94	CMM-A150
GSX1100ES(E/F/G)	84-86	CMM-G120
GSX1100FE(E/F/G)	84-86	CMM-G120
GSX1100E(Z/D)	82-83	CMM-G120
GSX1100E(T/X)	80-81	CMM-G120
GSX1100E(E/F/G)	84-86	CMM-G120
GSX1100(Z/D)	82-83	CMM-G120
GSX1100(T/X)	80-81	CMM-G120
GSXR1100K/L/M/N	89-92	CMM-HD122
GSXR1100G/H/J	86-88	CMM-G122
GSX1200X	99	CMM-A150
GSF1200	97-06	CMM-A150
GSF1250	07-10	CMM-A142
GSX-R1100W(P/R)	93-94	CMM-HD114
GSX1300B	08-09	CMM-A136
GSX1300R	99-08	CMM-A136
VS1400GLP	96-06	CMM-B142
VS1400GL(P/F)H-R	87-94	CMM-B142
VL1500	98-08	CMM-B142
VL1500LC	05-06	CMM-B142
VZ1600	04-05	CMM-J144
VL1800	08-10	CMM-E078(2)
		CMM-A116(2)
VZR1800	06-09	CMM-E078(2)
		CMM-A116(2)
		YAMAHA
TTR50E	08-07	CMM-Y084
TTR90	00-05	CMM-Y084
TTR90E	06	CMM-Y084
SR125	82-00	CMM-X104
TW125	99-03	CMM-X104
TTR125	05	CMM-X088
TTR125E	06	CMM-X088
TTR125LE	06	CMM-X088
TTR125L	06	CMM-X088
XC125 CYGNUS	96-00	CMM-M088
XV125	97-99	CMM-U110
XV125S	00	CMM-U110
XVS125	02	CMM-Y110
YP125 MAJESTY	98-02	CMM-M094
YP125E MAJESTY	03-09	CMM-M094
YP125R MAJESTY	98-99	CMM-M094
XC1235.T	91-	CMM-M088
XC150LC,LCS	90	CMM-M100
TW200	06	CMM-X104
YP250	96-98	CMM-M104
YP250A	99	CMM-M104
YP250D	98-99	CMM-M104
YP250R	00	CMM-M094
YP250R X-MAX	05-09	CMM-M104
YBR250	07-09	CMM-M104
VP250 X-CITY	07-10	CMM-M104
XT250L/LC	84	CMM-G090
XT250G/H/J/K/KC	80-83	CMM-G090
XS250D/E	78-82	CMM-G092
TT250G/H/J	80-82	CMM-G090
TTR250	05-06	CMM-B122
SR250TH		CMM-G090
SR250G/H/J	80-82	CMM-G090
WR250F	05-10	CMM-J114
XV250S	95-99	CMM-U110
XV250	95-06	CMM-U110
XV250K/KC	98	CMM-U110
YZ250F	02-10	CMM-J114
XT350U/UC/W/WC/A/AC	88-90	CMM-A136
XT350N/NC/S/SC/T/TC	85-87	CMM-A136
XT350B/BC/D/DC	91-92	CMM-A136
TT350S/T	86-87	CMM-A136
XS360	77	CMM-G092
XS400	79-81	CMM-G092
WR400F	98-02	CMM-J120
YP400 MAJESTY ABS	07-08	CMM-J136
YP400 MAJESTY	04-10	CMM-J136
YZ400	98-00	CMM-J120
WR426F	01-02	CMM-J120
WR450FR	03	CMM-FF118
WR450F	03-10	CMM-FF118
YZ450F	03-09	CMM-FF118
YZ450F	10	CMM-FF122
XP500	01-09	CMM-J132
XP500 T-MAX ABS	05-09	CMM-J132
XP500R	03	CMM-J132
XV500	83	CMM-A118
XT500	80-90	CMM-G106
TT500G/H	79-80	CMM-G106
SR500	80-90	CMM-G106
XV535	91-01	CMM-A118
XV535SE	87-89	CMM-A118
XV535S	86-97	CMM-A118
XZ500R/RK VISION	82-83	CMM-D112
XZ550	82	CMM-D112
XT550J/K	82-83	CMM-A126
XJ550	81-85	CMM-G114
FZ6-N	04-06	CMM-E120
FZ6-NS	05-06	CMM-E120
FZ6-S	04-06	CMM-E120
FZ6 S2 FAZER / ABS	08	CMM-E120
FZ6-SA FAZER	06	CMM-E120
FZ6-SA FAZER	07	CMM-Z122
FZ6 SHG FAZER	07	CMM-E120
FZ600	87-90	CMM-G114
FZR600R/RKC	98	CMM-S118
FZS600	98-03	CMM-J130

MODEL	STOCK NO	
FZS800P	02	CMM-J130
FZS800S	01	CMM-J130
FZS800SN	01	CMM-J130
FZS800R	03	CMM-J130
TT600R	99	CMM-A126
XJ6-F DIV.	10	CMM-FN120
XJ6 N	09-10	CMM-FN120
XJ6 S	09-10	CMM-FN120
XJ600	84-91	CMM-G114
XJ600SP/SPC/SE/SEC	92-93	CMM-G114
XJ600S DIVERSTION	92-98	CMM-B144
XJ600N	95-02	CMM-B144
XT600E	90-02	CMM-A126
XT600H/N	86-89	CMM-A126
XT600L/LC/N/NC/S/SC	84-86	CMM-A126
XT600T/TC/U/UC/W/WC	87-89	CMM-A126
XT600Z	83/90	CMM-A126
YX600S/SC/T/TC/U/UC	86-88	CMM-G114
YX600W/WC/A/AC	89-90	CMM-G114
YZF600R	96-06	CMM-SD118
YZF-R6	99-05	CMM-E120
YZF-R6	07	CMM-L118
YZF-R6	08-10	CMM-LN118
YZF-R6P	02	CMM-E120
YZF-R6S	08	CMM-E120
XJ6-S DIVERSION	09	CMM-FN120
XJ6-N	09	CMM-FN120
R46	05	CMM-E120
XJ650T TURBO	82-83	CMM-G120
XJ650	80-85	CMM-G120
XS650SE	79-81	CMM-G106
XS650	75-81	CMM-G106
XVS650	97-06	CMM-A118
XV650A	02-08	CMM-A118
XVS650AT	06-08	CMM-A118
SZR660	95-97	CMM-A126
XTZ660	92-93	CMM-A126
XTZ660 TENERE	08-10	CMM-FF126
XT660	91	CMM-A126
XT660X	04-09	CMM-FF126
XT660R	04-09	CMM-FF126
MT-03	06-09	CMM-FF126
XV700SS/SSC	86	CMM-A098
XV700L/LC/N/NC	84-85	CMM-A098
XV700CS/CSC/CT/CTC	86-87	CMM-A098
FZ750	85-91	CMM-G110
FZR750	87-88	CMM-G110
FZR750R	89	CMM-G104
FZR750R	90	CMM-G104
FZR750R	91-92	CMM-G104
FZX750	87-89	CMM-G110
XS750	78-79	CMM-G124
XS750SE	79-82	CMM-G124
XTZ750	89-90	CMM-A138
XV750A/AC/B/BC/D/DC	90-92	CMM-A098
XV750H/J/K/MK	81-83	CMM-A098
XV750SE	82	CMM-A098
XV750U/UC/W/WC	88-89	CMM-A098
YZF750R/J/RJC	97	CMM-G104
YZF-R7	99	CMM-HD100
YZR750R	93	CMM-G104
FZ8 N	11	CMM-FN124
FZ8 S	11	CMM-FN124
XS850	80-85	CMM-G124
TDM850H/N	91	CMM-A138
TDM850D/DC	92	CMM-A138
TDM850H/N	92-98	CMM-A138
TDM850/L	99	CMM-A138
TDM900	03-09	CMM-A138
TDM900R	03	CMM-A138
XJ900F	87-90	CMM-G120
XJ900	83-93	CMM-G120
XJ900 DIVERSION	94-00	CMM-A150
XJ900S/SN	01	CMM-A150
XJ900S	02	CMM-A150
XJ900SP	02	CMM-A150
XV920RH/RJ	81-82	CMM-A098
XV920J/K/MK	82-83	CMM-A098
XV1000	97	CMM-A098
XV1000L/LC/N/NC	84-85	CMM-A098
GTS1000A	93-94	CMM-G108
GTS1000	93-94	CMM-G108
FZR1000	87-88	CMM-G110
FZR1000	89-93	CMM-G108
FZR1000	94-95	CMM-G108
FZS1000	01-05	CMM-E130
FZS1000S	03	CMM-E130
FZS FAZER	01-05	CMM-E130
FZ1-N	06	CMM-Z122
FZ1-S	06	CMM-Z122
FZ-1	06-09	CMM-Z122
FZ-1 FAZER	06-10	CMM-Z122
FZ1 FAZER ABS	07-08	CMM-Z122
FZS10 FAZER	08-09	CMM-Z122
YZF1000R	96-01	CMM-GD108
YZF-R1	98-03	CMM-E130
YZF-R1	04-08	CMM-Z122
YZF-R1	09-10	CMM-ZN126
BT1100 BULDOG	03-05	CMM-E098
FJ1100L/LC	84	CMM-A156
XS1100G/S	78-84	CMM-G128
XV1100W/A/B/D	89-92	CMM-A098
XV1100S/T/U	86-88	CMM-A098
XV1100	89-95	CMM-A098
XVS1100	99-06	CMM-E098
XVS1100A	01-03	CMM-E098

MODEL	STOCK NO	
XVS1100AT	06	CMM-E098
XVS1100AW	06	CMM-E098
XVS11	08	CMM-E098
XJR1200	95-98	CMM-A156
XVZ12TK/TDK	83	CMM-G118
XVZ12L/KG2/DL/DKC2	84	CMM-G118
XVZ12DN	85	CMM-G118
VMX1200 V-MAX	86-93	CMM-G118
VMX12 V-MAX	98-06	CMM-G118
FJ1200	86-91	CMM-A156
FJ1200	92	CMM-A156
FJR1300A	03-05	CMM-E136
FJR1300	05-10	CMM-E136
XJR1300SP	99-03	CMM-A156
XJR1300	99-09	CMM-A156
XVS13A	08	CMM-FF132
XVZ1300A	00	CMM-G118
XVZ1300A	07	CMM-FF132
XVZ13CTM	06	CMM-G118
XVZ13CT	06-08	CMM-G118
XVZ13DS/DSC/DT/DTC	86-87	CMM-G118
XVZ13T/TC	87	CMM-G118
XVZ13U/UC/DU/DUC	88	CMM-G118
XVZ13TD	89	CMM-G118
XVZ13A/AC/B/BC	90-91	CMM-G118
XVZ13DD/DDC	92	CMM-G118
XVZ13AH/AHC/ATH/ATHC	96	CMM-G118
XVZ13AJ/AJC/ATJ/ATJC	97	CMM-G118
XVZ13LT	01	CMM-G118
XVZ13TF	01-06	CMM-G118
XVZ13TFM	04-06	CMM-G118
V-MAX (1700)	09-10	CMM-E134

REMARKS: CMM-F116 / CMM-F118
stock No. were changed to CMM-FF116 / CMM-FF118

REMARKS

CMM-E CMM-J CMM-Y

Rivet link

Shape of link plate(Rivet link only) was changed.

OLD → NEW



CAM SHAFT TIMING CHAINS for SCOOTER



CMM-Y094		HONDA	01-07
		SH125 SH150	01-07
		SUZUKI	95-00
		AN125 AN150	96-00
CMM-Y096		YAMAHA	06-09
		YP125R X-MAX	
CMM-Y098		HONDA	05-07
		NSS250EX FORZA NSS250X FORZA	05-07
CMM-M094		YAMAHA	03-08
		YP125E MAJESTY YP125 MAJESTY	98-02
CMM-B094		SUZUKI	08
		UX150 SIXTEEN	
CMM-B100		SUZUKI	02-09
		UH125 BURGMAN UH150 UH200 BURGMAN	02-06 07-09
CMM-BB108		SUZUKI	98-06
		AN250 BURGMAN AN400 BURGMAN AN400 BURGMAN	03-06 99-02
CMM-BB136		SUZUKI	07-08
		AN400 BURGMAN	
CMM-M098		HONDA	98-05
		FES250 FORESIGHT NSS250 NSS250A	01-04 01-04
CMM-J132		YAMAHA	05-09
		XP500 T-MAX ABS XP500 T-MAX	01-09
CMM-J136		YAMAHA	07-08
		YP400 MAJESTY ABS YP400 MAJESTY	04-08
CMM-J138		HONDA	03-07
		FJS400D SILVERWING FJS600 SILVERWING FJS600A SILVERWING	01-02 03-07

HI PERFORMANCE CAM CHAIN TENSIONER PUSH ROD KIT



PRK-101	
PUSH-ROD	1
HEAVY DUTY SPRING	2
O' RING	1
KZ1000J1-J3	81-83
KZ1000R1/R2	82-83
KZ1000K1/K2	81-82
KZ1000M1/M2	81-82
KZ1000P1/P2	82-83
KZ1100L1 LTD	83
KZ1100D1/D2	82-83
KZ1100B1/B2	81-82
KZ1100A1-A3	81-83
ZX1100A1/A2	83-84

PRK-102	
PUSH ROD	1
HEAVY DUTY SPRING	2
GASKET	1
KZ650H1-H3	81-83
KZ700A1	84
KZ700A2 LTD	85
KZ750E1-E3	80-82
KZ750F1 LTD	83
KZ750N1/N2	82-83
KZ750H1-H4 LTD	80-83
KZ750R1 GPZ	82
KZ750L3	83
ZX750E1/E2 TURBO	84-85
ZX750A1-A3	83-85

PRK-103	
PUSH ROD	1
HEAVY DUTY SPRING	2
O' RING	1
Z400J1-J3	80-82
KZ550F1/F2	83-84
KZ550H1/H2	82-83
KZ550M1 LTD	83
KZ550C1-C4	80-83
KZ550A1-A4	80-83
Z550B1-B4	79-82
ZX550A1/A2	84-85

PRIMARY CHAINS

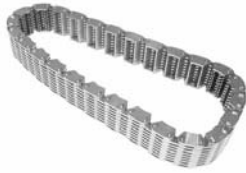

PCM-101	
REF:23131-463-003	60L
GL1200/I/A	84
GL1200I/A/L	85
GL1200I/A	86
GL1200I/A	87
GL1200E/DE/IE/AE	84
GL1100A/IA/DA	80
GL1100B/IB/DB	81
GL1100C/IC/DC/AC	82
GL1100D/ID/DD/AD	83
PCM-102	
REF:23131-371-004	60L
GL1000	75
GL1000L	75
GL1000K1/K2/K3/Z	76-79
PCM-103	
REF:13610-MA3-003	
CB1100RB/RC/RD	83
CB1100F	83
CB1000FD	83
PCM-104	
HONDA	
REF:13610-438-004	52L
CB1000	83
CB900CA	80
CB900F	81-82
CB900C	80-82
CB900FZ/FA/FB/F2B/FDC	79-82
CB900FD/F2D	83
KAWASAKI	
REF:13122-007	52L
KZ650B1-B3	77-79
KZ650C1-C3	77-79
KZ650D1-D2	78-79
KZ650E1	80
KZ650F1-F4	80-83
KZ650H1-H3	81-83
KZ700A1	84
KZ750E1-E3	80-82
KZ750H1-H4	80-83
KZ750L1-L3	81-83
KZ750N1-N2	82-83
KZ750R1	82
ZX750A1-A3	83-85
ZR750C1-C4	91-94
PCM-105	
REF:23131-422-004	58L
CBX	79-82
PCM-106	
REF:13610-393-004	50L
CB750K	79-82
CB750L	79
CB750KA	80
CB750C	80-82
CB750SC	82-83
CB750KZ/FA/FB/F2B/FC	79-82
PCM-107	
REF:14401-MA6-000	74L
CBX400F1/F2	

PCM-201	
REF:36Y-11456-00	50L
FJ1200	82
FJ1200	92
FJ1100L/LC	84
FJ1100	84-85
FZR1000	87-89
FZR1000A/AC	90
FZR1000B/BC	91
FZR1000	92-93
FZR750R	90
FZ750	88
FZ750N	85
PCM-202	
REF:2H7-16139-02	54L
XS1100E/F/G/H	78-81
XS1100SF/SH	79
XS1100LG/SG	80
XS1100H/LH	81
XJ1100J MAXIM	82
PCM-203	
REF:4H7-11456-00	52
XJ900	83-85
XJ900RN/FN	85
XJ750RH SECA	81
XJ750RJ SECA	82
XJ750J MAXIM	83
XJ750RK SECA	83
XJ750K/MK MAXIM	83
XJ650G/H/J/K	80-83
XJ650LH	81
XJ650RJ	82
XJ650LJ SECA	82
XJ650LK SECA	83
GTS1000	93-94
PCM-204	
REF:4G0-16139-00	50L
XJ550H MAXIM	81
XJ550J MAXIM	82
XJ550K MAXIM	83
XJ550RH SECA	81
XJ550RJ SECA	82
XJ550RK SECA	83
FJ600L/LC/N/NC	84-85
PCM-205	
REF:3J2-16139-00	72L
XS850G	80
XS850SG	80
XS850LG	80
XS850H	81
XS850LH	81
PCM-206	
REF:1J7-16139-04	72L
XS750D/E/F	77-79
XS750SE	78
XS750SE	80
XS750SF	79
PCM-207	
REF:12R-11456-01	48L
XS400J MAXIM	82
XS400RJ SECA	82
XS400RK SECA	83
XS400K MAXIM	83
PCM-208	
REF:4BR-16139-00	52L
XJ600S	92-95
PCM-209	
REF:4FM-11456-00	50L
FZR1000	94-95

KAWASAKI	
PCM-401	
REF:13122-005	74L
KZ400	74
KZ400D	75
KZ400A1/A2	77-78
KZ400B1/B2	78-79
KZ400D3/D4	76-77
KZ400H1	79
KZ400S/S2/S3	75-77
KZ4400A1-A3	80-82
KZ400B1/B2	80-81
KZ400D1-D5	80-83
KZ440G1	82
PCM-403	
KAWASAKI	
REF:92057-1011	50L
KZ550A1-A4	80-83
KZ550C1-C4	80-83
KZ550D1	81
KZ550F1/F2	83-84
KZ550H1/H2	82-83
KZ550M1	83
ZX550A1-A3	84-86
ZX600A1-A5	85-89
ZX600B1	87
ZX600C1-C5	88-92
ZL600A1/A2	86-87
ZR550B1-B3	90-92
HONDA	
REF: 23131-426-003	50L
REF: 23131-323-003	50L
CB500K/K1/K2 FOUR	
CB650 79-82	
PCM-404	
REF:92057-1229/1187	72L
EX500A1-A7	87-93
EX500B1-B4	88-91
EX500D1-D5	94-98
EN500A1-A4	90-93
PCM-405	
REF:92057-1127	46L
KZ1300A4-A5	82-83
PCM-406	
REF:92057-1016	50L
KZ1300A1-A3	79-81
PCM-407	
REF: 92057-1017	46L
KZ1300A1-A3(SECONDARY)	79-81
PCM-408	
REF:13122-008	76L
KZ1000F	79
KZ750G	80-81
KZ750M	82
KZ750S	82-83
KZ750K	83-84

CYLINDER HEAD COVER REED VALVE ASSY

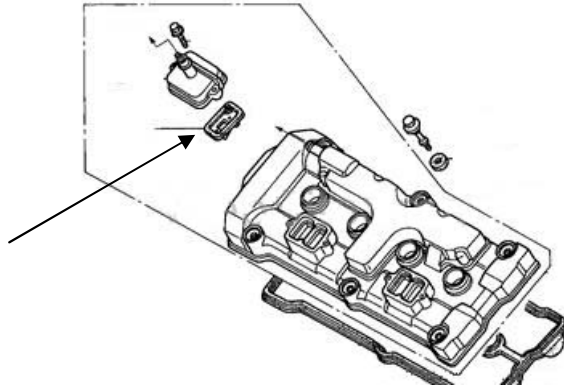

MC #	YEAR	MODELS	
CRV-101	04-07	CBR1000RR	
	01-06	CBR600F	
	01-04	CBR600F4	
	01-02	CBR600FR	
	01-02	CBR600FS	
	03-08	CBR600RR	
	2001	CBR900RE	
	00-03	CBR900RR	
	03-08	CB600F	
	07-08	CB600FA	
	02-07	CB900F	
	02-08	VFR800	
	02-08	VFR800A	
	06-08	CBF1000	
	06-08	CBF1000A	
	07-08	CBF1000S	
	07-08	CBF1000T	
	04-08	CBF600N	
	04-08	CBF600NA	
	04-08	CBF600S	
	04-08	CBF600SA	
	CRV-102	00-01	CB1100SF
		99-06	CBR1100XX
99-00		CBR600F4	
99-00		CBR600F	
07-08		CRF150R	
07-08		CRF150RB	
05-08		CRF250R	
04-08		CRF250X	
02-08		CRF450R	
05-08		CRF450X	
00-07		XR650R	
04-08		TRX450R	
06-08		TRX450ER	
CRV-103		00-06	VTR1000SP
	07-08	XL1000V	
	07-08	XL1000VA	
	07-08	XL125V	
	2008	XL700V	
	2008	XL700VA	
	01-02	VT750DC	
	06-08	NT700V	
	06-08	NT700VA	

MC #	YEAR	MODELS
CRV-104	05-07	CB1300
	05-07	CB1300A
	03-07	CB1300FI
	05-07	CB1300SA
	04-06	CBF250
CRV-105	02-10	ST1300
	02-10	ST1300A
	2005	ST1300P
	06-11	ST1300PA
	02-04	VTX1800C
	05-08	VTX1800C1
	05-06	VTX1800C2
	05-06	VTX1800C3
	05-08	VTX1800F1
	05-07	VTX1800F2
	05-08	VTX1800F3
	04-08	VTX1800N1
	04-07	VTX1800N2
	04-08	VTX1800N3
	02-03	VTX1800R
	04-07	VTX1800R1
	04-07	VTX1800R2
	04-07	VTX1800R3
	02-03	VTX1800S
	04-06	VTX1800S1
	04-06	VTX1800S2
	04-06	VTX1800S3
	07-08	VTX1800T
	07-08	VTX1800T2/T3
	03-07	VTX1300S
	05-09	VTX1300R
	04-09	VTX1300C
08-09	VTX1300T	
2010	VT1300CR/CS/CT/CX	

STARTER CLUTCH REPAIR KIT



Starter Clutch

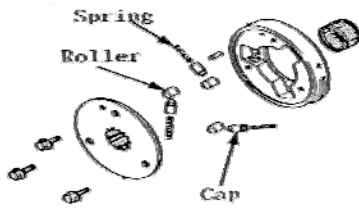

SCK-901	
ROLLER(15X13) X 3	
CAP(6.2 X 15.5) X 3	
SPRING X 3	
HONDA	
CX500	78-79
CX500C	79-82
CX500D	79-81
CX500TC	82
GL500	81-82
GL500I	81-82
CX650T	83
CX650C	83
CB750F	76-78
CB750F	79-82
CB750K	79-82
CB750L	79
CB750K	76-78
CB750C	80-82
CB750SC	82-83
CB900C	80-82
CB900F	81-82
GL650	83
GL650I	83
VF700F	84-85
VF700C	87
VF700C	84-86
VFR700F	86
VFR700F2	86-87
VF700S	84-85
VF750C	82-83
VF750F	83-84
VF750S	82-83
VF750C	88
VFR750	86
VF1100C	83-86
VF1100S	84-85
CB1000C	83
CB1100F	83
GL1000K	
GL1000K	76-79
GL1100L	76
GL1100L	80-83
GL1100I	80-83
GL1100A	82-83
GL1200	84
GL1200I	84-87
GL1200	84-87
GL1200L	85
GL1200SEi	86
SUZUKI	
GS425N/EN/LN	79
GS450LT/LX/LZ	80-82
GS450TX/TZ/TXZ	81-82
GS450TXD	83
GS450ED/LD	83
GS450ET/ST/EX/SX/EZ	80-82
GS450LF/LG/LH/LJ	85-88
GS450GAZ/GAD	82-83
GS450GAF	85
GS500EK/EL/EM/EN/EP/ER/ES/ET	89-96
GS500EV/EW	97-98
GS550B/C	77-78
GS550EC/N/EN/LN	78-79
GS550ET/LT	80
GS550TX/MZ	81-82
GS550LX/LZ	81-82
GS650EX/EZ	81-82
GS650GX/GZ	81-82
GS650GLX/GLZ/GLD	81-83
GS650MD KATANA	83

SCK-901	
GS650GD	83
GS750B/C	77-78
GS750EC/N/EN/LN	78-79
GS750LT/LX	80-81
GS750ET/EX	80-81
GS750EZ	82
GS750TZ/TD	82-83
GS750SD KATANA	83
GS850GN/GT/GX	79-81
GS850GLT/GLX	80-81
GS850GZ/GD	82-83
GS850GLZ/GLD	82-83
GS1000C/EC/N/EN	78-79
GS1000LN/SN	79
GS1000ST/ET	80
GS1000SZ	82
GS1100LT	80
GS1100ET/EX	80-81
GS1100SD	83
GS1150ES3/ESE/EF/ESF/EF2/EG/ESG	83-86
GSX-R1100G/H/J	86-88
GSF400M/N/P	91-93
KAWASAKI	
KZ440B1/B2	80-81
KZ440G1	82
KZ440D1-D5 LTD	80-83
EN450A1-A6	85-90
EN500A1-A7	90-96
EX500A1-A7	87-93
EX500D1-D5	94-98
KZ650C1-C3	77-79
KZ650D1-D1A/D2	78-79
KZ650B1-B3	77-79
KZ650F1	80
KZ650E1 LTD	80
KZ650H1/H2	81-82
KZ700A1	84
ZN700A1-A2	84-85
KZ750B1-B4	76-79
KZ750G1 LTD	80
KZ750F1 LTD	83
KZ750H1-H4 LTD	81-83
KZ750E1-E3	80-82
KZ750K1/K2	83-84
KZ750L3	83
KZ750N1/N2	82-83
KZ750R1 GP	82
KZ750M1 CSR	82
ZR750C1-C3	91-93
ZX750A1/A2 GPz	83-84
ZX750E1/E2 TURBO	84-85
ZL900A1/A2 ELIMINATOR	85-86
ZX900A1-A3	84-86
KZ1300A1-A4	79-82
KZ1300B2 TOURING	80
ZN1300A1-A4 VOYAGER	83-86
ZN1300A5-A6	87-88
SCK-902	
ROLLER(15 X 14.4) X 3	
CAP(6.2 X 15.5) X 3	
SPRING X 3	
KAWASAKI	
Z1/A/B/	73-75
KZ900A4/A5	76-77

SCK-902	
KZ900B1 LTD	76
KZ1000B1-B3 LTD	77-79
KZ1000D1-D3 ZIR	78-80
KZ1000A1-A4	77-90
KZ1000C1-C4 POLICE	78-81
KZ1000E1/E2 ST & SHAFT	79-80
KZ1000G1 CHASSIS	80
KZ1000J1-J3	81-83
KZ1000K1/K2 CHASSIS	81-82
KZ1000M1/M2 CSR	81-82
KZ1000R1/R2 REPLICA	82-83
KZ1000P1-P15	82-96
KZ1100A1-A3	81-83
KZ1100B1/B2 GP	81-82
KZ1100D1/D2 SPECTRE	82-83
KZ1100L1 LTD	83
ZN1100B1/B2 LTD	84-85
ZX1100A1/A2 GPz	83-84

SCK-903	
ROLLER(15 X 16.9) X 3	
CAP(6.2 X 14.1) X 3	
SPRING(90501-04503) X 3	
YAMAHA	
XS850G/SG/LG	80
XS850H/LH/SH	81
XS1100E/F/G/H	78-81
XS1100SF/SG/SH	79-81
XS1100LG/LH MIDNIGHT SPECIAL	80-81
FJ1100L/LC/N/NC	84-85
FJ1200S/SC/T/TC/W/WG/A/AC	86-90
FJ12000B/BC/D/DC/AD/ADC/AE/AEC	91-93

SCK-904	
ROLLER(15 X 12) X 3	
CAP(6.2 X 14.1) X 3	
SPRING(90501-04623) X 3	
YAMAHA	
XS400J/K MAXIM	82-83
XS400RJ/RK SECA	82-83
XJ550H/J/K MAXIM	81-83
XJ550RH/RJ/RK SECA	81-83
FJ600L/LC/N/NC	84-85
XZ550RJ/RK VISION	82-83
FZ600S/SC/T/TC/U/UC	86-88
XV535T/TC/U/UC VIRAGO	87-88
XV535W/WC/A/AC/B/BC VIRAGO	89-91
XV535D/DC/EC/EG/FG/SF/SFC VIRAGO	92-94
XV535G/GC/SG/SCG VIRAGO	95
FZR1000W/WC/A/AC/B/BC/D/DC	89-92
FZR1000E/EC/FC/G/GC	93-95
YZF750RF/RFC/RG/RGF/RH/RHC/RJ/RJC	94-97
YZF1000RJ/RJC	97
VMX12N/NC/S/SC/U/UC/W/WC V-MAX	85-89
VMX12A/AC/B/BC/D/DC/E/EC V-MAX	90-93
VMX12F/FC/G/GC/H/HG/J/JC V-MAX	94-97
VMX12K/KC V-MAX	98
XVZ12TK VENTURE	83
XVZ12DK VENTURE ROYALE	83
XVZ12L/KC2 VENTURE	84
XV12DL/DK2 VENTURE ROYALE	84
XVZ13DN/DS/DSG/DT/DTG V.ROYALE	85-87
XVZ13T/TC/U/UC VENTURE	87-88
XVZ13DU/DUC/DW/DWC/DA/DAC V.ROYALE	88-90
XVZ13DB/DBC/DD/DCG/DE/DEG V.ROYALE	91-93

SCK-905	
ROLLER(15 X 12) X 3	
CAP(6.2 X 14.1) X 3	
SPRING(90501-04596) X 3	
YAMAHA	
XJ650G/H/J/K MAXIM	80-83
XJ650LH MIDNIGHT	81
XJ650RJ SECA	82
XJ650LJ/LK SECA-TURBO	82-83
XJ750J/K MAXIM	82-83
XJ750RH/RJ/RK SECA	81-83
XJ750MK MIDNIGHT MASIM	83

WATER PUMP MECHANICAL SEALS



HONDA	
ref 19217-611-000	
19217-657-023	
CR80	83
CR125R	81-83
MTX125RWD	
MTX200RWD	
MTX200RWF	
CR250R	81-84
CX500TC	82
CX650C/T	83
GL650/1	83
YAMAHA	
11H-12438-00	
FZ400N/R	85
FZ400R(46X)	86
FZ400R(46X)	87
XZ550R VISION	82-83
FZ/FZX700	86-87
FZ750N-UC	85-88
FZR750RT/RU	87-88
FZR1000	87-96
YZF1000RJ/RJC	97
GTS1000AE/AEC/AF/AFc	93-94
YZF-R1	99-00
VMX12 V-MAX	85-00
XVZ12/XVZ13 VENTURE	83-93
& VENTURE ROYAL	
XVZ13AH/ACH/AJ/AJC	96-97
ROYAL STAR	
XVZ13ATH/ATJ ROYAL STAR	96-97
XVZ13LTJ/LTJC ROYAL STAR	97
XVZ13 ROYAL STAR	98-00
KAWASAKI	
ref 49063-1054	
KL250D2-D17 KLR	87-0
EN450 A1-A6 LTD	85-90
EN500AA-A7 VULCAN	90-96
EN500C1-C5 VULCAN	96-00
EX500AA-A7	87-93
EX500D1-D7	94-00
KL600A1/B1/B2 KLR	84-86
KL650A1-A14 KLR	84-00
KL650B2/B3 TENGAI	90-91
KLX650A1-A3	93-95
KLX650C1-C4 DUAL	93-96
KLX650D1	96
KAWASAKI	
49063-1052	
VN700A1 VULCAN	85
VN750A2-A16	86-00
VN800A1-A6 VULCAN	95-00
VN800B1-B5 VULCAN	96-00
VN800C1/C2 VULCAN	99-00
VN1500A1-A9 VULCAN	87-95
VN1500A10-A12 VULCAN	96-98
VN1500B1-B4 VULCAN	87-90
VN1500C3/C4 VULCAN	96-97
VN1500D1/D2 VULCAN	97-98
VN1500E1 VULCAN CLASSIC	98

WMS-901

WMS-902

WMS-903

SUZUKI	
ref 17470-46A01	
17470-46A00	
RM80D/E/F	83-85
RM125X/Z/D/E/F	81-85
RM250	82-85
GSF400M/N/P BANDIT	91-93
RF600RP/RR/RS/RT	93-96
GSX-R600WN/WP	92-93
GXSX-R600V/W/X/Y	97-00
GV700GLF/GLF2 MADURA	85
VS700GLFG/FLGH INTRUDER	86-87
VS700GLPG/GLPH INTRUDER	86-87
VS700GLEFG/GLEFH INTRUDER	86-87
VS700GLEPG/GLEPH INTRUDER	86-87
VS750GLPJ/K/L/M INTRUDER	88-91
GSX-R750WP/WR/WS	93-95
GSX-R750T/V/W/X	96-99
VX800L/M/N	90-93
VS800GLN/P/R/S/T/V/W/X/Y	92-00
VZ800V/W/X/Y MARUDER	97-00
RF900RR/RS/RT/RV	94-97
GSX-R1100W P/R/S/T/V/W	93-98
GV1200GLF/GLF2/GLG MARUDA	85-86
GSX1300R X/Y HAYABUSA	99-00
GV1400GDD/GDH/GDJ GAVALCA	86-88
GV1400GCG/GCH CAVALCADE	86-87
SUZUKI	
17470-02F10	
DR-Z400 Y/EY	00
DR-Z400 Y DUAL SPORT	00
SV650X/Y	99-00
GSX-R750 Y	00
TL1000S V/W/X/Y	97-00
TL1000R W/X/Y	98-00
KAWASAKI	
49063-1057	
VN1500E2/E3 VULCAN CLASSIC	99-00
VN1500G1/G2/G1A/G2A	99-00
VN1500J1/J2 VULCAN DRIFTER	99-00
VN1500N1 VULCAN CLASSIC F1	00
VN1500L1 VULCAN NOMAD F1	00
KAWASAKI	
49063-1002	
KMX125	86-96
KMX200	89-90
KDX200H1-H6	95-00
KDX2200A4-A7	97-00
KLX250D2-D4	94-96
KLX300A2-A5	97-00
ZX600F1-F3	95-97
ZX600G1/G2 ZX-6R	98-99
ZX900C1/C2 ZX-9R	98-99
ZX900E1 ZX-9R	00
ZX1200A1 ZX-12R	00
KAWASAKI	
XL1000V	
VTR1000F	98-03
VTR1000SP	00-03
ST1300	02-03
ST1300A	02-03
KAWASAKI	
FL400R	
FL400R	89-91

WMS-904

WMS-905

WMS-906

WMS-907

WMS-908

WMS-909

ENGINE OIL SEAL KIT



HONDA

Oil seals in STARTER MOTOR, ALTERNATOR are not included.

<i>STREET</i>		<i>QTY</i>
OSL-101	MBX50C MTX50RE MBX80SWD/FWD 83 MTX80RFD/RSD 83	7
OSL-102	MT80SA 80 MTX80C	6
OSL-105	CX500CA/CB/CC/A/B/C/D 80-82	6
OSL-107	VT500ED 83 VT500C SHADOW 83-85 VT500FT ASCOT 82-84	5
OSL-109	VF750CC/CD/SC/SD 82-83 VT750C 83 VF700S 84-85 VT700C 84-85 VF1100C MAGNA 83-86 VF1100S SABRE 84	5
OSL-110	CB650 80-82 CB650C 80-81 CB650SC 82	7
OSL-112	CB900FZ/FA/FB/F2B CB900F2C/FD/F2D CB750FZ/FA/FB/FC/F2C 79-82 CB1100RB/RC 81-82	7
OSL-113	XL500S 79-81 XR500 79-80	6
OSL-114	CB750K1/K2	7
OSL-115	VFR750 L-S 88-95	4
OSL-116	VFR800FI W/X/Y/1 98-01	4
OSL-117	XL1000V X/Y 98-00	5
OSL-118	VTR1000F V-1 97-01	5
OSL-119	CBR900RR 92-95 CBR900RR 98-01	3
OSL-120	CBR600F M-W 91-98 CB600F W-Y 98-00 CB600F2 Y 00	3
OSL-121	GL1500A P-R 93-94 GL1500SE P-R 93-94	12

MOTOCROSS

OSL-151	CR80R 85-99
OSL-152	CR125R 84-85
OSL-153	CR125R 86
OSL-154	CR125R 90-99
OSL-155	CR250R 84
OSL-156	CR250R 85 CR500R 85-87
OSL-157	CR250R 86-87
OSL-158	CR250R 88-91
OSL-158	CR500R 88-99
OSL-159	CR250R 92-98
OSL-161	CR80R 80-82
OSL-162	CR80R 83
OSL-163	CR80R 84
OSL-164	CR125R 87-89
OSL-165	CR500R 84

YAMAHA

<i>STREET</i>		<i>QTY</i>
OSL-204	DT125LC 82 RD125LC 82	8
OSL-206	XT250G/H/J 80-82 XT250K/KG 83	10
OSL-207	RD250LC 82 RD350LC 82	9
OSL-209	XT550H/K 82-83 XT600L/LC/NC 84-85 XT600Z 84	10
OSL-210	SR500 82 SR500G/H 80-81 XT500G/H 80-81	10
OSL-211	XS400 82 XS400SE 82	6
OSL-212	XS400J/K MAXIM 82-83 XS400RJ/RK SECA 82-83	5
OSL-213	XS650G/H/SJ/SK 80-83	10
OSL-214	XJ550H/J/K 81-83 XJ550RH SECA 81-82	6
OSL-216	XJ650 83 XJ650LK SECA 83 XJ650K MAXIM 83 XJ750J/K 82-83 XJ750RK SECA 83 XJ900 83	5
OSL-217	XV750H/J/K VIRAGO 81-83 XV750SE 82 XV920J/K VIRAGO 82-83	5
OSL-218	XV1000 82	6
OSL-219	XV1000L/LC/N/NC 84-85 XV1000SE 83 XV1100 89-95	6
OSL-221	XJ900S 95-97	4
OSL-222	XJ900S 98-01	4
OSL-223	XV535 90-00 XV535S 96-97 XV535SE 88	4
OSL-224	SZR660 95-97 XT600E 96-99	5
OSL-225	XJ600S 92-96	7
OSL-226	XJ600S 97-99	7
OSL-227	XT600Z 88	7
OSL-228	XVS650 97-01	6
OSL-229	TDR125 96	8
OSL-230	XT600E 90-95	5
OSL-231	FZR1000 89-95 YZF1000R 96-00	6
OSL-232	RD350 73-75 RD400 76-79	9

<i>MOTOCROSS</i>		
OSL-251	YZ80H/J	81-82
OSL-252	YZ80K/L/N	83-85
OSL-253	YZ80S/T/U/W/A/B/D	86-92
OSL-254	YZ80E1/F1/G1	93-95
	YZ80H1/J1/K1	96-98
	YZ80L1/M1	99-00
OSL-255	YZ125J/K/L/N	82-85
OSL-256	YZ125S/T/U	86-88
OSL-257	YZ125W/A/B/D1/E1	89-93
OSL-258	YZ125F1/G1/H1/J1	94-97
OSL-259	YZ125K1/L1/M1	98-00
OSL-260	YZ250J	82
OSL-261	YZ250K/L/N	83-85
	YZ250S/T	86-87
OSL-262	YZ250U/W/A/B/D1	88-92
	YZ250WRW/WRA	89-90
	YZ250E1/F1/G1/H1/J1	93-97
OSL-263	YZ250K1	98
OSL-264	YZ250L1	99
	YZ250M1	00
OSL-265	WR400FK/FL/FM	98-00
	YZ400FK/FL	98-00
	YZ426FM	00

KAWASAKI

<i>STREET</i>			
OSL-421	Z900A4	76	8
	Z1	73-75	
OSL-422	H2		8
OSL-423	ZX750A1/A2	83-84	5
	ZR750C1-C4	91-94	
OSL-424	ZR550B2-B5	91-94	5
	ZX600C1-C9	88-96	
	ZX600A1		
OSL-425	Z650B1-B3	77-79	7
	Z650C2-C3	78-79	
	Z650D2	79	
OSL-426	H1 500 /A/B/D/E/F	69-75	
	KH500A8	76	

<i>MOTOCROSS</i>		
OSL-451	KX80C1/G2	81-82
	KX80E1	83
	KX125B1/B2	82-83
	KX125C1	84
OSL-452	KX80E2	84
OSL-453	KX80E3	85
	KX80G1/G2	86-87
	KX80J2	87
	KX80L1/N1	88
OSL-454	KX80L2/L3	89-90
	KX80N2/N3	89-90
	KX80T1-T4	91-94
	KX80R1-R7	91-97
	KX100B5-B7	95-97
OSL-455	KX80W1-W3	98-00
	KX100C1-C3	98-00
OSL-456	KX125D1	85
	KX125E1	86
	KX125E2	87
OSL-457	KX125F1/F2	88-89
OSL-458	KX125H1/H2	90-91
	KX125J1/J2	92-93

OSL-460	KX250C1/G2	83-84
	KX250D1	85
OSL-461	KX250D2	86
	KX250E1	87
OSL-462	KX250F1/G1	88-89
OSL-463	KX250H1	90
OSL-465	KX500A1/A2	83-84
OSL-466	KX500B1/B2	85-86
OSL-467	KX500C1/G2	87-88
OSL-468	KX500E1-E10	89-00

SUZUKI

OSL-301	GSX750F K-Y	89-00	4
	GSX-R1100 G/H/J	86-88	
	GSF600S S-Y	95-00	
	GSX600F J-Y	88-00	
	GSF1200(S/SA)T-Y	96-00	

<i>MOTOCROSS</i>		
OSL-351	RM80D/E/F	83-85
OSL-352	RM80G/H/J	86-88
OSL-353	RM80K	89
OSL-354	RM80L/M/N/P/R	90-94
	RM80S-Y	95-99
OSL-355	RM80Y	00
OSL-356	RM125X/Z/D	82-83
	RM125E/F	84-85
OSL-357	RM125G/H/J	86-88
OSL-358	RM125K	89
OSL-359	RM125L/M	90-91
OSL-360	RM125N/P/R/S	92-95
	RM125T/V/W	96-98
OSL-361	RM15X/Y	99-00
OSL-362	RM250X/Z/D	81-83
OSL-363	RM250E/F	84-85
OSL-364	RM250G/H/J	86-87
OSL-365	RM250K/L/M/N/P	89-93
OSL-366	RM250R/S	94-95
OSL-367	RM250T/V/W/X/Y	96-00

REMARKS:

OSL-455: 92049-1468 Kick starter oil seal is not included in the kit.

OSL-459/464 : no longer available

AIR FILTER



MC ID	O.E.REF
AFE-001	17213-MG2-000
AFE-002	17230-MM9-000
AFE-003	17230-MG3-000
AFE-004	17210-ML0-000
AFE-008	17210-KW3-000
AFE-009	17211-MM5-000
AFE-101	17211-MA6-000
AFE-102	17210-MA2-000
AFE-103	17210-MB0-000
AFE-104	17215-MB0-000
AFE-105	17216-MB2-000
AFE-106	17210-MB1-000
AFE-107	17213-MC4-000
AFE-109	17220-ME2-000
AFE-110	17210-MB4-000
AFE-111	17221-MC8-000
AFE-112	17210-KE7-000
AFE-113	17213-KA2-000
AFE-114	17211-463-000
AFE-115	17211-371-004
AFE-116	17211-425-000
AFE-117	17211-341-000
AFE-118	17211-392-000
AFE-119	17211-405-000
AFE-120	17211-426-000
AFE-121	17211-426-640
AFE-122	17211-460-000
AFE-123	17211-447-620
AFE-124	17220-415-003
AFE-125	17211-413-000
AFE-126	17213-422-000
AFE-127	17210-333-610
AFE-129	17210-404-670
AFE-130	17210-390-003
AFE-138	17211-428-000
AFE-143	17213-402-000
AFE-163	17211-ME5-000
AFE-167	17220-MG7-000
AFE-168	17213-MK4-000
AFE-170	17211-MJ0-611
AFE-171	17216-MB6-000
AFE-172	17210-KN7-830
AFE-173	17210-MB0-700
AFE-174	17214-397-003
AFE-175	17213-397-003
AFE-176	17211-168-060
AFE-177	17210-ML7-000
AFE-180	17213-KG0-000
AFE-181	17210-KM3-000
AFE-182	17213-KE4-000
AFE-183	17211-MG9-000
AFE-184	17210-KT8-000
AFE-185	17210-ML4-000

MC ID	O.E.REF
AFE-186	17226-MF5-000
AFE-187	17210-MF2-000
AFE-188	17213-KE1-000
AFE-189	17210-KC1-003
AFE-191	17213-KL4-000
AFE-198	17215-MK7-770
AFE-1A0	17210-MF2-780
AFE-1A1	17210-MN9-000
AFE-1A3	17213-MG8-000
AFE-1A4	17213-MK4-700
AFE-1A5	17213-KE5-000
AFE-1A6	17211-KM7-910
AFE-1A7	17210-KY2-700
AFE-1A8	17210-KT7-000
AFE-1A9	17210-MR7-600
AFE-1B1	17211-MS2-000
AFE-1B2	17210-KE8-000
AFE-1B4	17213-MM2-770
AFE-1B5	17210-MF5-751
AFE-1B6	17211-KM1-770
AFE-1B7	17211-431-672
AFE-1B8	17211-477-620
AFE-1B9	17211-MC9-860
AFE-1C1	17230-MV1-000
AFE-1C2	17213-MW2-780
AFE-1C4	17213-KF0-000
AFE-1C5	17213-MR4-900
AFE-1C6	17213-KB7-000
AFE-1C7	17211-MZ1-000
AFE-1C8	17211-MZ2-000
AFE-1C9	17205-MR1-000
AFE-1D1	17213-MN1-670
AFE-1D2	17230-MY9-000
AFE-1D3	17211-MW3-700
AFE-1D4	17215-MM8-010
AFE-1D5	17211-GJ1-000
AFE-1D6	17230-MS6-920
AFE-1H1	17205-063-020
AFE-1H10	17216-MJ4-000
AFE-1H12	17210-120-000
AFE-1H13	17210-KY1-000
AFE-1H14	17211-028-680
AFE-1H16	17211-GE1-770
AFE-1H17	17211-MA6-750
AFE-1H18	17213-383-670
AFE-1H19	17213-GC4-830
AFE-1H21	17254-958-013
AFE-1H22	17313-950-003
AFE-1H23	17210-310-000
AFE-1H24	17210-MJ8-000
AFE-1H25	17211-041-000

MC ID	O.E.REF
AFE-1H26	17211-302-770
AFE-1H27	17211-KC1-000
AFE-1H28	17211-MC8-000
AFE-1H29	17213-437-000
AFE-1H3	17210-MV4-000
AFE-1H30	17213-KA3-830
AFE-1H31	17214-418-710
AFE-1H32	17310-310-000
AFE-1H33	17210-344-630
AFE-1H34	17210-MK7-000
AFE-1H35	17211-041-015
AFE-1H36	17211-341-770
AFE-1H37	17211-KC1-300
AFE-1H38	17211-ME5-670
AFE-1H39	17213-471-000
AFE-1H4	17211-168-000
AFE-1H40	17213-KK0-000
AFE-1H41	17214-KS4-000
AFE-1H42	17310-344-630
AFE-1H43	17210-369-000
AFE-1H45	17211-098-771
AFE-1H46	17211-375-000
AFE-1H47	17211-KJ2-003
AFE-1H48	17211-MJ1-000
AFE-1H49	17213-GB4-010
AFE-1H50	17213-KR1-760
AFE-1H51	17214-MF5-751
AFE-1H52	17310-369-000
AFE-1H53	17210-374-003
AFE-1H54	17210-MT4-000
AFE-1H55	17211-107-020
AFE-1H56	17211-399-003
AFE-1H57	17211-KN7-830
AFE-1H58	17211-MJ1-670
AFE-1H59	17213-GB4-680
AFE-1H6	17211-KV3-000
AFE-1H61	17215-ME9-000
AFE-1H62	17310-375-000
AFE-1H63	06170-MAL-600
AFE-1H64	17225-MAK-000
AFE-1H65	17210-MAT-000
AFE-1H66	17230-MY1-000
AFE-1H67	17230-MY9-000
AFE-1H68	17230-MR5-000
AFE-1H69	17215-MG8-771
AFE-1H7	17212-KE6-830
AFE-1H70	17210-MN0-003
AFE-1H8	17213-GC4-730
AFE-1H9	17213-MG8-000
AFE-1J1	17213-MBA-010
AFE-201	2F3-14451-00
AFE-202	4E2-14451-00
AFE-203	4X7-14451-00
AFE-204	4H7-14451-00

AFE-205	4U8-14451-00
AFE-206	2J2-14451-00
AFE-207	2H7-14451-00
AFE-208	31A-14451-00
AFE-209	1A8-14451-00
AFE-210	1A0-14451-01
AFE-211	1A2-14451-00
AFE-212	5Y1-14451-00
AFE-213	1L9-14451-00
AFE-214	4L0-14451-00
AFE-215	360-14451-90
AFE-216	463-14451-09
AFE-217	22U-14450-00
AFE-218	47X-14451-00
AFE-219	33M-14451-00
AFE-220	29L-14451-00
AFE-221	583-14451-09
AFE-222	1AE-14451-00
AFE-223	36Y-14451-00
AFE-224	12R-14451-00
AFE-226	1JK-14451-000
AFE-227	533-14451-00
AFE-228	306-14451-00
AFE-229	34L-14451-00
AFE-230	34L-14461-00
AFE-231	51Y-14451-000
AFE-232	355-14451-09
AFE-235	30X-14451-00
AFE-236	29U-14451-00
AFE-241	1M1-14451-00
AFE-242	1V8-14451-00
AFE-243	1KT-14451-00
AFE-244	1HX-14451-00
AFE-245	3X8-14451-00
AFE-246	2G1-14451-00
AFE-247	46X-14451-00
AFE-248	11H-14450-00
AFE-249	372-14451-00
AFE-251	3Y1-14451-00
AFE-252	2A6-14451-00
AFE-253	1WG-14451-00
AFE-255	1UF-14451-00
AFE-256	42X-14451-00
AFE-257	2GV-14451-00
AFE-258	3GM-14451-00
AFE-259	26H-14451-00
AFE-260	34K-14451-00
AFE-261	3LD-14451-00
AFE-262	2YK-14451-00
AFE-263	2RW-14451-00
AFE-264	3TB-14451-00
AFE-265	2UJ-14451-00
AFE-266	3FV-14451-00
AFE-267	4FM-14451-00
AFE-268	4BH-14451-00
AFE-269	1FK-14451-00
AFE-270	1VJ-14451-00
AFE-271	2RH-14451-00
AFE-272	34X-14451-00

AFE-273	3YF-14451-00
AFE-274	4BR-14451-00
AFE-275	2NT-14451-00
AFE-280	10L-14451-00
AFE-281	3BN-14451-01
AFE-282	1AA-14451-00
AFE-284	2VJ-14451-00
AFE-2Y10	4PT-14451-00
AFE-2Y11	4NK-14451-00
AFE-2Y2	2H9-14451-00
AFE-2Y3	3LN-14451-00
AFE-2Y4	3TJ-14451-00
AFE-2Y5	438-14451-01
AFE-2Y6	447-14451-01
AFE-2Y7	4G0-14451-00
AFE-2Y8	5H0-14451-00
AFE-2Y9	4RF-14451-00
AFE-2Y12	4XV-14451-00
AFE-301	13780-49310
AFE-302	13780-45500
AFE-303	13780-49200
AFE-304	13780-49000
AFE-307	13781-44010
AFE-308	13781-44100
AFE-310	13781-37400
AFE-311	13781-28210
AFE-312	13780-31300
AFE-313	13781-29310
AFE-314	13780-43400
AFE-315	13780-31310
AFE-316	13780-15500
AFE-319	13781-20A01
AFE-323	13781-01A00
AFE-324	13780-00A00
AFE-325	13781-44500
AFE-326	13780-49070
AFE-327	13781-39110
AFE-328	13780-38301
AFE-329	13780-38300
AFE-330	13781-38200
AFE-331	13781-36500
AFE-332	13781-36010
AFE-333	13780-35012
AFE-334	13780-34200
AFE-335	13780-30900
AFE-336	13781-20400
AFE-337	13780-18410
AFE-338	13780-14600
AFE-339	13780-14500
AFE-340	13781-14200
AFE-341	13781-11300
AFE-342	13780-27A00
AFE-343	13780-06B00
AFE-344	13780-31210
AFE-345	13780-17C00
AFE-346	13781-14A00
AFE-347	13780-44B00
AFE-348	13780-38A50
AFE-349	13781-38B00
AFE-350	13781-38B50
AFE-351	13780-48B10

AFE-352	13781-30B01
AFE-353A	13780-32C00
AFE-354	13780-01D00
AFE-355	13781-34C00
AFE-356	13781-12C00
AFE-358	13780-20C00
AFE-359	13780-12D00
AFE-360	13780-14D02
AFE-361	13780-17E00
AFE-362	13780-03D00
AFE-364	13780-33C00
AFE-370	13780-24B00
AFE-371	13780-38A00
AFE-372	13780-21E00
AFE-373	13781-34C10
AFE-3S1	13780-05110
AFE-3S10	13781-30900
AFE-3S11	13781-31310
AFE-3S12	13781-45010
AFE-3S13	13781-47010
AFE-3S14	13781-47030
AFE-3S15	13780-26D00/10
AFE-3S16	13780-02F00
AFE-3S18	13780-48E00
AFE-3S2	13780-08021
AFE-3S5	13780-24B00
AFE-3S7	13781-04A00
AFE-3S8	13781-14A00
AFE-3S9	13781-17200
AFE-401	11013-034
AFE-402	11013-051
AFE-403	11013-058
AFE-404	11013-059
AFE-406	11013-063
AFE-407	11013-1002
AFE-408	11013-1006
AFE-409	11013-1013
AFE-410	11013-1015
AFE-411	11013-1025
AFE-413	11013-1037
AFE-414	11013-1040
AFE-415	11013-1058
AFE-416	11013-1060
AFE-418	11013-1112
AFE-419	11013-1128
AFE-420	11013-1154
AFE-421	11013-1021
AFE-422	11013-027
AFE-423	11013-054
AFE-424	11013-1180
AFE-425	11013-1001
AFE-426	11013-1167
AFE-427	11013-1014
AFE-429	11013-1027
AFE-430	11013-1034
AFE-432	11013-1139
AFE-433	11013-1059
AFE-434	11013-1062
AFE-435	11013-1072
AFE-436	11013-1074

AFE-437	11013-1101
AFE-438	11013-1107
AFE-439	11013-1108
AFE-440	11013-1110
AFE-441	11013-1114
AFE-442	11013-1121
AFE-443	11013-1125
AFE-444	11013-1126
AFE-445	11013-1152
AFE-446	11013-1155
AFE-447	11013-1122
AFE-448	11013-1117
AFE-448Z	11013-1185

AFE-449	11013-1188
AFE-449Z	11013-1209
AFE-450	11013-1189
AFE-451Z	11013-1226
AFE-452	11013-1157
AFE-452Z	11013-1227
AFE-480	11013-055
AFE-481	11013-1243
AFE-482	11013-1232
AFE-4K1	11013-019
AFE-4K10	11013-1210
AFE-4K11	11013-1224
AFE-4K12	11016-008

AFE-4K2	11013-046
AFE-4K3	11013-052
AFE-4K4	11013-1011
AFE-4K5	11013-1012
AFE-4K6	11013-1038
AFE-4K7	11013-1039
AFE-4K9	11013-1168

VALVE STEM SEALS



VSS-101	
14730-028-013	
14730-GB0-911	
09289-05008	
HONDA	
ATC70	73-85
TRX70	86-87
ATC90/K1-K3	70-75
ATC90	76-78
CT90	66-79
SL90	69
SUZUKI	
GSX550E(F/G/H)	85-87
GSX550EU(F/G/H)	85-87
GSX550EF(F/G/H)	85-87
GSX550ES(F/G/H)	85-87
VSS-102	
12209-300-003	
12209-429-005	
12209-MC8-005	
12209-MN1-671	
12209-MB9-003	
HONDA	
CX650E(D)	84
CX650C	83
CB750A	76-77
GL1200A	84-87
GL1100I	81-82
CX650	83
GL1200I	84-87
GL650/I	83
GL1200SEI	86
GL1100I	80
GL1100A	82
GL1100A	83
GL1100	80
GL1100I	83
GL1100	81-83
CX500TC	82
CB750F	75-76
GL1200L	85
CB750K	69-78
GL1000L	76
CB750F	77-78
CX500	78-79
CX500C/D	79-82
GL1200	84
GL1000	75-79
VT800C	88
VT1100C	87-90
VT750C	83-85
VT1100C	92-95
FT500	82-83
XR600R(P-R)	93-94
XR500R	83-84
XL500R	82
XL500S	79-81
XR600R(P-R)	85-87
NX650(N-R)	92-94
XR500R	81-82
XR500R	79-80
VSS-103	
12209-333-005	
HONDA	
CB650C	80-81
CB500/K1/K2	71-73
CB550F	75-77
CB650SC	82
CB650	79-82
VSS-104	
12209-MA6-005(-003)	
12209-KE8-005	
HONDA	
VT250C(S)	95
CBX750F(E)	84
CBR600F	87-90
CBX550F	82

VSS-105	
12209-422-005	
HONDA	
XR250/R	79-82
XR250L	91-95
XR250R	81-95
XL250R	82
XL350R	84-85
XL250S	78-81
XR350R	83-85
CBX	79-82
VF750C V45	82-83
VF1100C	83-86
VF1000R	85-86
CB1100F	83
CB750F(Z/A/B/C)	79-82
VF1100S V65	84-85
CB900F(Z/A/B/C)	79-82
VF750F V45	83-85
VF1000F2(F/G)	85-86
CB750C	80-82
CB750SC	82-83
VF750S	82-83
CB900C	80-82
CB900F2(B/C)	81-82
VF1000F	84-86
CB750K	79
GL1500SE	90-94
GL1500SE	88-89
GL1500I	91-94
GL1500A	91-94
VSS-106	
12208-413-003	
12209-KL4-005	
HONDA	
XL400V(N/R)	92-94
XL250R	84-87
XR250R(N-S)	92-95
CBR1000F(P-S)	93-95
CBR400R(G/H)	86-87
CB1000F(S)	95
CBR1000F	87-88
CBR1000F	90-91
VSS-107	
12209-413-003	
HONDA	
VT500FT	83-84
XL600V	89-90
NTV650J	88
CB450SC	82-86
NT650	88-91
VSS-107(Cont)	
VT500C	83-84
XR650J	88
CM450A/C/E	82-83
VT600C(R-S)	94-95
CM400A/C/E/T	79-81
XR750(L/M/N/R/S)	90-95
VSS-108	
12209-ML0-722	
HONDA	
NX250J	88
VFR750R(J)	88
CBR900RR(N-S)	92-95
ST1100(L-R)	90-94
VSS-108S	
12208-ML0-721(-722)	
09289-04002	
HONDA	
VFR400R	89-92
VFR750F(L-S)	90-95
SUZUKI	
GSX-R1100W(P/R)	93-94
GSX-R600W(N)	92
RF900R(R/S)	94-95
GSXR750W(N/P/R)	92-94
RF600R(U/P/R)	93-94

VSS-109	
12209-GB4-682	
HONDA	
CB750F2	92-95
VSS-110	
12209-KT7-013	
HONDA	
CBR600F	92-94
CBR600F2	91-94
VSS-201	
1J7-12119-01	
1L9-12119-02	
YAMAHA	
XS1100E/F	78-79
XJ900	83-85
XJ750MK	83
XJ650C/H/J/K	80-83
XJ750J/K	82-83
XS1100LG/LH	80-81
XJ750RH/RJ/RK	81-83
XS1100SF	79
XJ650RJ	82
XJ1100J	82
XS1100SG/SH	80-81
XS1100G/H	80-81
XJ650LJ/KL	82-83
XS850L/LH	80-81
XS750D/2D/E/F	77-79
SRX600S/SC	86
XS400RJ/RK	82-83
XS400SG/SH/SJ	80-82
X600H/N	87
XS400E/2F	78-79
XS400SE	82
XS400D/E/F/G/H	77-81
XS400J/K	82-83
XV535SE	88
TT600K/L/M/S	83-86
XT600Z	84/88
XT550J/K	82-83
XS360C/D/2D	76-77
VSS-202	
341-12119-02	
YAMAHA	
XS650	75-83
XV750SE	82
XV920J/K	82-83
XV1000SE	83
XV750H/J/K	81-83
XV1000L/LC/N/NC	84-85
XV920RH/RJ	81-82
XV1000	82
XV920MK	83
TT500C/D/E/F/G/H	76-81
XT500C/D/E/F/G/H	76-81
SR500E/F/G/H	78-81
SR500E/F/G/H	82-88
XT500	88
VSS-203	
33M-12119-00	
YAMAHA	
FZ750	88
FZR1000(2LA)	87
VSS-204	
51Y-12119-00	
YAMAHA	
XT350H/N	88
XT350H/N	85-94
VMX12N-SC	85-86
VMX12	88-94
FJ1200	88
TDM850	91
VSS-205	
5H0-12119-00	
YAMAHA	
XZ550RJ/RK	82-83
VSS-206	
30X-12119-00	
YAMAHA	
FJ1100	84-85
FJ1100L/LC/N/NC	84-85

VSS-207	
4G0-12119-00	
YAMAHA	
XJ550H/J/K	81-83
XJ600	84
XJ550RH/RJ/RK	81-83
FJ600L/LC/N/NC	84-85
VSS-208	
1WG-12119-00	
YAMAHA	
FZR750	90
FZR600B/BC	91
VSS-301	
09289-07002	
SUZUKI	
GS550E(C/N/T)	78-80
GS850E(N/T/X)	79-81
GS850G(E/F/G)	84-86
GS850GL(T/X)	80-81
GS500E(C/N)	78-79
GS1000L(N)	79
GS750E(C/N)	78-79
GS1000S(N)	79
GS550M(X/Z)	81-82
GS1000E(C/N/T)	78-80
VSS-301(Cont)	
GS550I(N/T)	79-80
GS1000GL(X)	81
GS550(B/C/N)	77-79
GS1000(C/N/T)	78-80
GS650G(X/Z/D)	81-83
GS1000H	78-80
GS1000G(T/X)	80-81
GS750D(C/N)	78-79
GS750(B/C/N)	77-79
GS450I(T/X)	80-81
DR600R/RU(G/H/J/K)	86-89
GS450S(T)	80
DR600S(N)	92
GS500E(K/L/M/N)	89-92
GS500E(K/L/M/N)	89-94
GS400(B/C/N)	77-79
DR650R(L)	90
DR650RE(R/S)	94
DR600REU	94
DR600S(F/G/H)	85-87
GN400L(T)	80
VSS-302	
09289-05003	
SUZUKI	
GSX250(T/X/Z)	80-82
GSX250E(T/X/Z)	80-82
GSX250ES(X)	82
GSX250E(Z/D)	82-83
GSX250ES(Z)	82
GSX400E(T/X)	80-81
GSX250Z	82-83
GSX250S(Z)	82
VS750GLF(F/G/H)	85-87
GSX400S	80-87
DR250S(F)	85
DR250S(Z/D)	82-83
GSX750I(X)	80-81
GSX750S(Z)	82
GSX750ES(D/E)	83-84
GSX1100EX(D)	83
GSX1100E	80-86
GSX400FE(X)	81
GSX750EF(F)	85
GSX1100ES(D/E/F/G)	83-86
GSX750EF(E)	84
GSX1100S(Z/D)	82-83
GSX1100(T/X/Z/D)	80-83
GSX750L(T)	80
GSX750E(T/X/Z)	80-82
GSX1100EF(E/F/G)	84-85

VSS-303	
09289-05011(-05010)	
DR350(L/M/N/P/R/Σ90-95	
DR250SES	94
DR250S(L/M/N/P/R) 90-	94
DR250(L/M/N/P)	90-93
DR350S(L/M/N/P/R/90-95	
GSX-R1100	86-91
GSX1100G(M/N/P/R/91-94	
GSX600FJ/K/L/M/N 88-82	
GSX-R750(F/G)	85-86
GSX750F KATANA	89-94
GSX1100F(J/K/L/M/ 88-92	
VSS-305	
09289-05015	
SUZUKI	
VX800U(L/N)	90-94
GN250	85-94
VSS-401	
92046-016	
KAWASAKI	
KZ900B1 LTD	76
KZ1100A1-A3	81-83
KZ750H1-H4	80-83
VN1500C1/C2	94-95
KZ750R1 GPZ	82
KZ650E1/F1	80
KZ1000D3 Z1R	80
KZ750E1-E3	80-82
VN1500B VULCAN	87-90
KZ1100D1/D2	82-83
KZ1100L1 LTD	83
KZ1100B1/B2 GPZ	81-82
KZ650B1/B3	77-79
KZ750N1/N2	82-83
KZ650C1/C2/C3	77-79
KZ1000G1 LTD	80
KZ650H1 CSR	81
KZ100D1 Z1R	78
KZ650D1/D2	78-79
Z1000H1	80
ZR1100A1-A3	92-94
KZ1000A1/A2	77-78
ZX1100A1/A2	83-84
KZ1000K1/K2 LTD	81-82
Z1/A/B	73-75
KZ1000B1-B4 LTD	77-80
KZ900A4/A5	76-77
VN150A VULCAN	87-94
KZ750L3	83
KZ1000A3-A4	79-80
ZR750C1/C2/C3/C4	91-94
KZ1000J1/J2/J3	81-83
KZ750F1 LTD	83
KZ650H2/H3	82-83
ZX750A1-A3 GPZ	83-85
KZ1000M1/M2	81-82
KZ1000E1/E2	79-80
KZ1000R1/R2	82-83
ZX750E GPZ	84-85
KZ400C1	78
KZ440D1-D5 LTD	80-83
KZ440G1	82
KZ400H1 LTD	79
KZ440B1/B2	80-81
KLX650A1/A2	93-94
KZ440A1-A4 LTD	80-83
KL650A <KLR650>	87-94
KZ400B1/B2	78-79
KZ400A1-A2	77-78
KZ400	74-77
KL650-C1 <KLR650>	95
KL650B TENGAI	90-91
KLX650C1/C2	93-94
KZ400S/S2/S3	75-77
KZ250D LTD	80-81
KZ250L1	82
KL250A3-A5	80-82
KZ200A1/A2	78-79
KL250A1/A2	78-79
KL250C1/C2	83-84
KZ250W1 LTD	83
KZ1300A1-A4	79-82
KZ1300B2	80

VSS-402	
92049-1050	
92049-1153	
KAWASAKI	
KZ550C1/C2	80-81
ZX550A1/A2 GPZ	84-85
KZ550C3/C4	82-83
KZ550A1-A4	80-83
KZ550F2 LTD	84
KZ550F1	83
KZ550M1	83
ZR550B1-B5	90-94
KZ550H1/H2	82-83
KZ550D1 GPZ	81
VSS-403	
92049-1062	
92049-1218	
KAWASAKI	
KX500D1	94
EL250B1/B2/B3	87-89
EN500A1-A5	90-94
EX500A1-A7	87-93
VN750A2-A11	86-95
EN450A LTD	85-90
KZ305B1	82
EX350B1 GPZ	83
KL250D2-D11<KLR>	85-94
KZ305A1/A2	81-82
KZ305B2/B3	87-88
ZX750G2<GPZ750R>	85
ZX1000A1/A2	86-87
ZG1200A1	87
ZX1100E1	95
ZX900A	84-86
ZG1200B	88-94
ZG1000A	86-94
EL250B	88-89
EL250E1	91
EX250E/F	86-94
EX250F6/F7/F9	92-95
EX250H1/H2/H3/H5	90-94
EL250D4/D5	93-94
ZX600A1-A3	85-87
ZX600C1/C2	88-89
ZX600B	87
ZX1100D1/D2/D3	93-95
ZX750H1/H2	89-90
ZX100B1-B3 ZX10	88-90
ZX1100E1	95
ZX1100C ZX11	90-93
ZX750F	87-90
VSS-405	
92049-1308	
KAWASAKI	
ZX400L1/L2	91-92
ZX600E1/E2	93-94
ZX400H1-H2	89-90
ZX400L1-L4	91-94
ZX400J1/J2	89-90
ZX600F1	95



MUFFLER CONNECTING GASKET

HONDA

NON ASBESTOS

MCG-101C			
REF:18391-292-300			
GL1000/K1/K2	75-77	C	
CB450K5-K7	72-74	C	
CB400F		B	
MCG-102C			
18391-310-000			
GL1500J/K	88-89	A	
CBX	81-82	C	D
CBX	79-80	C	
CB750F1/F2	77-78	C	
VFR750F G/H	86-87	A	
MCG-103C			
18391-313-000			
VF750C(C/D/E)MAGNA	82-83	A	
VF750S SABRE	82-83	A	
XL250S A/B	80-81	C	
XL250S Z	79	C	
MCG-104C			
18391-317-000			
VF750C(C/D/E) MAGNA	82-83	B	
VF750S SABRE	82-83	B	
VFR750F(G/H)	86-87	D	
CX650E(D)	83	A	
CX650C	83	A	
GL650(D)	83	A	
GL650D(D/2D)	83	A	
GL500D(D)	82	A	
VT500E(D)	83	B	D
VT500C(D)	83	A	B
GL500(B)	81	A	
CX500D(A)	80	A	
GL500(B/C)	81-82	A	
CX500A	80	A	
CX500B	81	A	
XR350R(F/G/H)	85-87	C	
MCG-107C			
18391-413-000			
CM400T(Z/A/B)	79-81	A	
CM400A(Z/A/B)	79-81	A	
CB400N(C)	82	A	
CB400N/NA	79-80	A	
CB250ND(C)	82	A	
CB250N/NA/NB	79-81	A	
MCG-106C			
18391-375-000			
CB400F		C	
MCG-108C			
18392-413-000			
GL1000K3/Z	78-79	C	D
VFR750F(J/K)	88-89	A	
CX650C	83	B	
GL650(D)	83	B	
CX650TD TURBO	83	C	
CX650C	83	B	
CB650SC(D)	83	D	
CX650ED	83	B	
CBX650E(D)	83	D	
GL650D(D/2D)	83	B	
CX500TC(C)	82	B	
CX500D(A)	80	B	
CX500A	80	B	
GL500D SILVERWING	82	B	
GL500(B/C)	81-82	B	
GL500(B)	81	B	
GL500D(C)	82	B	
MCG-108C			
CX500B	81	B	
CM400T(Z/A/B)	79-81	B	
CM400A(Z/A/B)	79-81	B	
CB400N/NA	79-80	B	
CB400N	82	B	
CB250ND	82	B	
CB250N/NA/NB	79-81	B	

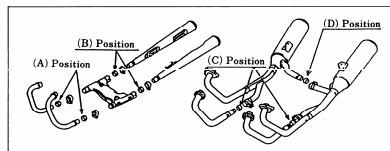

MCG-109C			
18391-425-000			
VF1000RE	84	A	
VF1000F(E)INTERCEPTOR	84	A	
CB750KZ	79	B	
CB650C	80-81	C	
MCG-110C			
18391-438-000			
CB1100R(D)	83	D	
CB1100F(D)	83	C	
CB1100R(C)	82	C	D
CB1100R(B)	81	C	D
CB900FB	81	C	
CB900F2B	81	C	
CB900FC/F2C	82	C	
CB900FZ/FA	79-80	C	
CB750FZ/FA/FB/FC/F2C	79-82	C	
CBX550FC/F2C	82	D	
CX500C(B/C)	81-82	A	
CX500C(A)	80	A	
XL250R(E/F)	83-84	C	
MCG-111C			
18391-437-000			
NX650J		A	
XR200	80-83	C	
XL185SZ/SA/SB	79-81	C	
MCG-112C			
18391-429-000			
GL1200E/DE/IE/AE	84	D	
GL1100A/IA/DA	80	D	
GL1100C/IC/DC/AC	82	D	
GL1100B/IB/DB	81	D	
XL600LM	85	B	
XL600R	83-87	B	
VF500F INTERCEPTOR	84-85	B	
XL500RC	82	C	
FT500 ASCOT	82	B	
XL500S/SA	79-80	C	
MCG-113C			
18392-449-000			
VF1000F(E)INTERCEPTOR	84	B	
VF1000RE	84	B	
VF750F(D/E)INTERCEPTOR	83-84	B	
VF500FF	85	B	
CX500C(B/C)	81-82	B	
CX500C(A)	80	B	
MCG-114C			
18391-461-000			
CB1100F(D)	83	D	
CB1100F(D)	83	D	
CB1000C	83	D	
CB900FC/F2C	82	D	
CM250CC	82	D	
MCG-115C			
18391-KE8-000			
VF500C/FE/F2E/FF		A	
MCG-117C			
18391-MLO-003			
CBR1100XX V/W/X	97-99	B	
CBR1000F(P-T)	93-96	B	
CBR1000F(J)	88	B	
CBR600F HURRICANE	87-90	B	
CBR1000F(L-T)	90-96	B	
CBR600F(M-T)	91-96	B	
CBR600F V/W	97-98	B	
VF800FI	98	C	

MCG-118C			
18392-MG7-750			
VTR1000FV w	98	C	
CB600F w	98	B	
XL1000V X	99	D	
VT1100C	97-98	D	
MCG-119C			
18392-MK4-000			
XL1000V X	99	C	
XR250R	96-98	B	
VT1100C	97-98	C	
YAMAHA			
MCG-201			
1L9-14714-01			
XS1100S	81	C	D
XS1100	80-81	C	D
XJ900	83-84	B	
XS850	80	C	
XS750SE	80	D	
XS750SE	78	D	
XJ750RJ/RK SEGA	82-83	B	
XJ650	80-82	B	
XT550(5Y5)	82-83	C	
XS400	80-82	C	
MCG-202C			
1J7-14714-00			
XV1000 TR1	81-82	C	
XV920RH/RJ	81-82	C	
XS850G	80	B	
XV750K/H/SE	81-83	C	
XS750SE	78	C	
MCG-203C			
4H7-14714-00			
XJ750RJ/RK SEGA	82-83	A	
XJ650 11R/4K0	82	A	
XJ650 27G/4K0	83	A	
XJ650 27F/4K0	83	A	
XJ550	83	A	
XJ550	81	A	
XV500	83-87	C	
XJ650H/J	81-82	C	
XZ550RJ/RK	82-83	C	
MCG-204C			
4H7-14755-00			
XJ650H/J	81-82		
XZ550RJ/RK	82-83	B	
MCG-205C			
2J2-14714-00			
SR500	91-92	C	
SR500	87/88	C	
SR500	78-82	C	
MCG-206C			
2G2/31A-14714-00			
XV1000 TR1	81-82	C	D
XJ900F	85-94	A	
XJ900	83-84	A	
XS850	80	D	
XS750SE	80	C	
XS650SE	80-81	D	
XV500	83-87	C	
XS400SE	81-82	D	
MCG-207C			
1T1-14714-01			
XV1000SE	83	C	
XV750SE	81-82	C	
FJ600L/LC/N/NC		D	
XT500	78-83	C	
XT500	86-89	C	

MCG-208C		
1T4-14714-00		
XS750D/E	77-78	C
MCG-209C		
36Y-14755-01		
FJ1200	86-88	A
FJ1200A	89	B
FJ1100	84-85	A
FZ750	85-86	C D
FZX750	87-88	D
MCG-210C		
34K-14714-00		
XV1000SE	86-88	C
XT600H/N	86-88	C
XT600L/LC/N/NC		C
XT600Z	83-90	C
MCG-211C		
3HE-14755-00		
FZR1000	89-95	B
GTS1000	93-94	B
FZR1600W	89	B
FZR600A/AC	90	B
FZR600B	91	B
MCG-212C		
36Y-14714-00/3XW-14714-00		
FJ1200	92	B
FJ1100	84-85	B
FJ1200	86-88	B
FZR600	94-95	B

SUZUKI

MCG-301C		
14771-47010/47000/47020		
GS650GX/GZ	81-82	C
GS550MX/MZ	81-82	C
GS550D(T)	80	C
GS550E(C/N)	78-79	C
GS550LN	79	C
GS550LT	80	C
GS550(B/C/N)	77-79	C
GSX550E/ES/EF/EU	84-87	C
GSX250Z/EZ/SZ/ESZ	82	C
GSX250T/ET/X/EX	80-81	C
MCG-302C		
14771-44010/44000/45000		
GS750D(B./C/N)	77-79	C
GS750E(C/N)	78-79	C
GS750B/C/N	77-79	C
MCG-303C		
14771-44011/44020		
GS850G(N)	79	C
GS850GT/GX	80-81	A B
GS850G(E/F/G)	84-86	C
GS750LN	79	A B
GS400B	77	C
MCG-304C		
14771-49000/49001/49010		
GS1100LT	80	C
GS1000C/EC/N/EN/ET	78-80	C
GS1000SZ	82	C
GS1000LN	79	C
GS1000H(C/N/T)	78-80	C
GS1000GT/GLT/GX/GLX	80-81	C
GSX750E(T/X/Z)	80-82	C
GSX750LT/LX	80-81	C
GSX750(T/X)	80-81	C
GSX750S(Z)	82	C
MCG-306C		
14771-14A01		
DR600S(F/FU/G/UG)		
MCG-307C		
14771-05A02		
VS800GL(P/R/N)	90-92	A
VS750GL(J/K/L/M)	88-91	A
VS750GL(G/H)	86-87	A
MCG-308C		
14771-38B01		
VS1400GL(L/M/N)	90-92	A
VS1400GLP(P/R)	93-94	A

KAWASAKI

MCG-401C			
11009-1001/1638/1718			
KZ1000A1-A2	77-78	D	
ZX600C1-C5	88-92	D	
ZX600A1-A5A	85-89	A D	
MCG-402C			
11009-1002/1637			
ZX1100A1/A2	83-84	C D	
KZ1000A1-A2	77-78	B	
KZ1000J1/J2	81-82	C D	
Z1000R2		C D	
ZX900A1-A2	84-85	D	
ZX750E1/E2	84-85	B	
KZ750R1 GPZ	82	B	
ZX750A3	85	B	
ZX750A1/A2	83-84	B	
KZ750L3-L4	83-84	B	
MCG-403C			
11009-1073/1634/1667			
KZ750L3-L4	83-84	A	
KZ750H1-H4 LTD	80-83	C	
ZR750C1-C4	91-94	B	
ZX750A3 GPZ	85	A	
KZ750E1-E3	80-82	C	
KZ750L1-L2	81-82	C	
KZ750R1 GPZ	82	A	
KZ550A1-A4	80-83	C	
ZX550A1	84	C	
KZ550C1-C4	80-83	C	
EN500A1-A4 VULCAN	90-93	D	
EX500A1-A3	87-89	B	
EX500B1-B4	88-91	B	
EX500A4-A6	90-92	B	
EN450A1-A6	85-90	B D	
MCG-404C			
11009-1011/1800/1639			
ZG1300A1	84	C	
Z1300A1-A5	79-83	C	
KZ750L1-L2	81-82	D	
KZ750H1-H4 LTD	80-83	D	
KZ750E1-E3	80-82	D	
KZ650C2-C3	78-79	C D	
KZ650B1-B2	77-78	C D	
KZ550A1-A4	80-83	D	
KZ550C1-C4	80-83	D	
ZX550A1 GPZ550	84	D	
KZ440D2-D4		D	
KZ440A1-A3	81-82	D	
MCG-405C			
11009-1104/1480/1666			
Z1300A1-A5	79-83	B	
ZG1300A1	84	B	
ZX900A1-A2	84-85	B	
VN750A1-A5	86-89	A B	
ZX750G1-G3	84-86	B	
KL650B1/B2/B3 TENGAI	89-91	A	
KL600A1/B1/B2 KLR	84-86	C	
MCG-406C			
11009-1668/1617/1504/1659			
ZG1200B6	92	D	
ZX1100RX A1/A2	86-87	D	
ZX750G1-G3	84-86	D	
ZL600A1/A2	86-87	C	
MCG-410C			
11009-1888			
ZX1100E1	95	D	
ZX1100D1-D4	93-96	D	

25.4X31.4X25.0	MCG-114C
28.5X32.5X30.0	MCG-203C
28.7X34.5X25.0	MCG-103C
28.7X34.5X34.0	MCG-111C
31.9X37.5X26.0	MCG-401C
32.0X34.5X25.0	MCG-115C
32.0X37.5X25.0	MCG-106C
32.0X38.0X30.5	MCG-206C
35.0X39.6X32.0	MCG-301C
35.0X41.0X25.0	MCG-102C
35.0X41.0X25.0	MCG-403C
35.0X41.5X32.0	MCG-109C
35.0X42.5X23.0	MCG-207C
37.5X44.0X20.0	MCG-107C
38.0X43.0X25.0	MCG-303C
38.0X44.5X28.0	MCG-110C
38.0X44.5X28.0	MCG-119C
38.15X44.1X26.0	MCG-406C
38.2X43.5X26.0	MCG-402C
38.2X44.2X24.0	MCG-104C
38.5X42.5X30.0	MCG-204C
38.5X44.5X25.0	MCG-201C
40.5X44.5X25.0	MCG-202C
41.0X47.1X30.0	MCG-304C
41.0X50.0X30.0	MCG-302C
41.2X48.6X34.5	MCG-205C
42.5X46.5X25.0	MCG-210C
42.7X48.5X29.0	MCG-101C
42.7X48.6X28.0	MCG-113C
42.8X48.5X26.0*	MCG-410C
42.8X48.5X30.0	MCG-405C
42.8X48.6X20.0	MCG-108C
42.8X48.6X30.0	MCG-112C
43.0X48.5X20.5	MCG-118C
45.3X50.0X35.0	MCG-212C
46.5X54.5X25.0	MCG-208C
48.6X54.6X28.0	MCG-117C
52.0X59.0X31.0	MCG-211C

ENGINE VALVE SHIM

7.5 MM DIA.

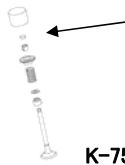

- K-75 Starter kit for Kawasaki
- S-75 Starter kit for Suzuki
- Y-75 Starter kit for Yamaha
- H-75 Starter kit for Honda



STARTER KIT contains 50 pcs in total covering following sizes

- K-75 → 2.55/2.60/2.65/2.70/2.75/2.80/2.85/2.90/2.95/3.0 EACH 5 PCS
- S-75 → 1.40/1.45/1.50/1.55/1.60/1.65/1.70/1.75/1.80/1.85 EACH 5 PCS
- Y-75 → 1.50/1.55/1.60/1.65/1.70/1.75/1.80/1.85/1.90/1.95 EACH 5 PCS
- H-75 → 1.80/1.85/1.90/1.95/2.00/2.05/2.10/2.15/2.20/2.25 EACH 5 PCS

	SIZE	K	S	Y	H	KAWASAKI	SUZUKI	YAMAHA	HONDA
V75-135	1.35					ZX600E1-E12'93-04	GSX-R600'96-03	FZR600'89-99	NX250'88-90
V75-140	1.40		5			ZX600D1-D4'90-93	GSX-R600W'92-93	FZR1000'89-95	CB1 400'89-90
V75-145	1.45		5			ZX600F1/F3'95-97	GSX-R750'96-03	FZS600'98-03	CBR600F'91-92
V75-150	1.50		5	5		ZX600J1/J3'00-02	GSX-R750W'92-95	FZS1000'01-04	CBR600F'93-03
V75-155	1.55		5	5		ZX600G1/G2'98-99	GSX-R1000'01-04	YZF-R6'97-03	CBR600F4'99-03
V75-160	1.60		5	5		ZX600K1-K2'03-04	GSX-R1100W'93-98	YZF-R7'99	CBR600FS'01-02
V75-165	1.65		5	5		ZX636A1'02	RF600RR'94-96	YZF-R1'98-03	CBR600FSR'02
V75-170	1.70		5	5		ZX600B1-B2'03-04	RF900RR'94-97	YZF1000R'96-01	CB600F'98-04
V75-175	1.75		5	5		ZX750J1/J2'91-92	SV650'99-03	YZF750R'94-98	CB600F2'00
V75-180	1.80		5	5	5	ZX750K1/K2'91-92	SV650S'99-03	GTS1000'93-94	CBR900RR'92-03
V75-185	1.85		5	5	5	ZX750L1-L3'93-95	GSX-R600Z K3'03	YZ250F'02-03	CBR900RE'01
V75-190	1.90			5	5	ZX750M1/M2'93-94			CB900F'02-03
V75-195	1.95			5	5	ZX750P01-P3'96-98			CBR1100XX'97-03
V75-200	2.00				5	ZX900B1-B4'94-97			VF750C'94-03
V75-205	2.05				5	ZX900C1/C2'98-99			VF750CD'95-96
V75-210	2.10				5	ZX900E1/E2'00-01			VFR750F'90-93
V75-215	2.15				5	ZX900F1/F2'02-03			VFR750F'94-97
V75-220	2.20				5	EJ650A1-A4'98-02			VFR750R'90
V75-225	2.25				5	EJ650C5'03			VFR800'98-03
V75-230	2.30					ZR1000A1-A2'03-04			VF800A'02-03
V75-235	2.35					KLX250D2-D4'94-96			FJS600'01-02
V75-240	2.40					KLX250E1/E2'93-94			FJS600D'03
V75-245	2.45					KLX300A2-A10'97-04			FJS600A'03
V75-250	2.50					KL250G4-G7'00-03			ST1100'91-02
V75-255	2.55	5							ST1100A'99-02
V75-260	2.60	5							CB1100SF'00
V75-265	2.65	5							ST1300'02-03
V75-270	2.70	5							ST1300A'02-03
V75-275	2.75	5							RVF750R'94
V75-280	2.80	5							GL1800'01-04
V75-285	2.85	5							GL1800A'01-04
V75-290	2.90	5							NRX1800DA/DE'04
V75-295	2.95	5							NRX1800EA/EB'04
V75-300	3.00	5							

9.5MM DIA.

- K-95 Starter kit for Kawasaki
- S-95 Starter kit for Suzuki

- K-95 → 2.30/2.35/2.40/2.45/2.50/2.55/2.60/2.65/2.70/2.75 EACH 5 PCS
- S-95 → 2.60/2.65/2.70/2.75/2.80/2.85/2.90/2.95/3.00/3.05 EACH 5 PCS

Starter kit contains 20 pcs

	SIZE	K	S	KAWASAKI	SUZUKI
V95-230	2.30	5		VN800A1-A10'95-04	GSX600F'92-97
V95-235	2.35	5		VN800B1-B9'96-04	GSX-R750'91-92
V95-240	2.40	5		VN800E1/E3'01-03	GSX-R1100 M/N'91-92
V95-245	2.45	5		VN800C1/C2'99-00	GSX100'91-92
V95-250	2.50	5		ZX750H1/H2'89-90	GSX1300R'99-03
V95-255	2.55	5		ZX1000B1-B3'88-90	TL1000S'97-01
V95-260	2.60	5	5	ZX1100D1-D8'93-00	TL1000R'98-03
V95-265	2.65	5	5	ZX1100E1-E3'95-97	DL1000 '02-03
V95-270	2.70	5	5	ZX1100C1-C4'90-93	SV1000'03
V95-275	2.75	5	5	ZX1200A1/A2'00-01	SV1000S'03
V95-280	2.80		5	ZX1200B1/B2'02-03	
V95-285	2.85		5	ZX1200C1/C3'02-04	DR-Z400'00-03
V95-290	2.90		5	ZR1100C1-C3'97-99	DRZ400S'00-04
V95-295	2.95		5	ZR1100D1-D4'97-00	DR-Z400E'00-04
V95-300	3.00		5	ZR1200A1-A3'01-03	LT-Z400S'03-04
V95-305	3.05		5	ZR1200B1-B3'01-03	
V95-310	3.10			ZR1200C1/C2'01-03	
V95-315	3.15				
V95-320	3.20				
V95-325	3.25				
V95-330	3.30				

25MM DIA



HY-25 Starter kit for Honda/yamaha

HY-25 → 2.30/2.40/2.50/2.55/2.60/2.70/2.80/2.90/3.00/3.10
 Starter kit contains 20 pcs

	SIZE	H & Y	HONDA	YAMAHA
V25-230	2.30	2	CB750KZ'79	XT250L/LC'84
V25-235	2.35		CB750FZ/FA/FB/FC'79-82	SRX250 T/TC'87
V25-240	2.40	2	CB750F2C'82	XT350'86-00
V25-245	2.45		CB900FZ'79	XJ600S'92-99
V25-250	2.50	2	CB900FA/FB/FC'80-82	XJ600 SECAL'92-98
V25-255	2.55	2	CB900F2B/F2C'81-82	XJ600N'00-02
V25-260	2.60	2	CB1100R B/C/D'81-83	XJ900S'95-02
V25-265	2.65		CB1100F '83	XJR1200'95-98
V25-270	2.70	2	CBX Z/A/B/C'79-82	XJR1300'99-02
V25-275	2.75		CB750C'80-82	XVZ12D VENTURE ROYAL'84-85
V25-280	2.80	2	CB750K'79-82	XVZ12T/TD'83
V25-285	2.85		CB750L'79	XVZ12 VENTURE'87-88
V25-290	2.90	2	CB1000C'83	XVZ13D'86-93
V25-295	2.95		CB900C'80-82	XVZ1300 ROYAL STAR'96-02
V25-300	3.00	2		VMX12 V-MAX'85-03
V25-305	3.05			XVZ1300 ROYAL STAR'96-02
V25-310	3.10	2		FJ1100'84-85
				FJ1200'88-93

29MM DIA.

KY-29 Starter kit for Kawasaki/yamaha

KY-29 → 2.30/2.40/2.50/2.55/2.60/2.70/2.80/2.90/3.00/3.10 EACH 2 PCS
 Starter kit contains 20 pcs

	SIZE	K & Y	KAWASAKI	YAMAHA
V29-230	2.30	2	KL600A1'84	XS400J/K'82-83
V29-235	2.35		KL600B1/B2'85-86	XS400R/RK'82-83
V29-240	2.40	2	KL650A1-A16'92-02	XJ550H/J/K'81-83
V29-245	2.45		KL650B1-B3'89-91	XJ550RH/RJ/RK'81-83
V29-250	2.50	2	KLX650A1-A3'93-95	FJ600L/N'84-85
V29-255	2.55	2	KLX650C1-C4'93-96	FZ600'86-88
V29-260	2.60	2	KL650C9'03	YX600'86-90
V29-265	2.65		KZ1000A1-A4'77-80	XJ600'84
V29-270	2.70	2	KZ1000B1-B4'77-80	XJ650G/H/K'80-83
V29-275	2.75		KZ1000E1/E2'79-80	XJ650LH'81
V29-280	2.80	2	KZ1000G1'80	XJ650RJ'82
V29-285	2.85		KZ1000J1-J3'81-83	XJ650'83
V29-290	2.90	2	KZ1000K1/K2'81-82	XJ650LJ/LK'82-83
V29-295	2.95		KZ1000M1/M2'81-82	XJ750J/K'82-83
V29-300	3.00	2	KZ1000R1/R2'82-83	XJ750MK'83
V29-305	3.05		KZ1000P1-P15'82-96	XJ750RH/RJ/RK'81-83
V29-310	3.10	2	Z1/A/B'73-75	XS750D/2D/F'77-79
			KZ900A4/A5'76-77	XS750SE/SF'78-79
			KZ900B1 LTD'76	XS850G/H'80-81
			KZ1100A1-A3'81-83	XS850LG/SG/SH'80-81
			KZ1100B1/B2'81-82	XJ900RK'82
			KZ1100L1 LTD'83	XJ900'83-85
			KZ1300A1-A4'79-82	XJ1100J'82
			KZ1300B2'80	XS1100E./F/G/H'78-81
			ZN1100B1/B2'84-85	XS1100LG/LH'80-81
			ZN1300A1-A6'83-88	XS1100SF/SG/SH'79-81

CAMSHAFT PLUG SETS

YAMAHA

CSP-201ST	
1J7/2G2-11138-00 X 2 PC	
XS400R(J/K) SECA	(82-83)
XS400J/K MAXIM	(82-83)
XJ650L(J)	(82)
XJ650L(H)	(81)
XJ650(G/H)	(80-81)
XS750(F)	(79)
XS750S(F)	(79)
XS750SE	(78)
XS750L(G)	(80)
XS750SE	(80)
XS750(E)	(78)
XS850(G)	(80)
XS850	(81)
XS850L(G)	(80)
XS1100L(H) MIDNIGHT SP	(81)
XS1100S(F/G/H)	(79-81)
XS1100	(80)
XJ1100 MAXIM	(82)

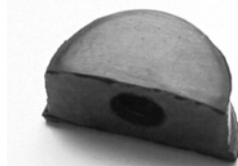

SUZUKI

CSP-301ST	
09241-23002 X 4 PC	
GSX400ET/ST/EX/SX	(80-81)
GS400C/EC/N/EN	(78-79)
GS425N/EN	(79)
GS550(B-X)	(77-81)
GS550E(C-X)	(78-81)
GSX750L(T/X)	(80-81)
GS750D(C/N)	(78-79)
GS750E(C/N)	(78-79)
GSX750(T/X)	(80-81)
GSX750E(T)	(80)
GSX750S(Z)	(82)
GS750(C/N)	(78-79)
GS750L(N)	(79)
GS850G(N/T/X)	(79-81)
GS850G(Z/D)	(82-83)
GS1000(C/N/T)	(78-80)
GS1000GL(X)	(81)
GS1000H(C/N/T)	(78-80)
GS1000S(N/T)	(79-80)
GS1000L(N)	(79)
GS1000E(C/N/T)	(78-80)
GSX1100S(E)	(84)
GSX1100E(Z/D)	(82-83)
GSX1100(Z/D)	(82-83)
GSX1100T	(80)
GSX1100E(T)	(80)
GSX1100L(T)	(80)

KAWASAKI

CSP-401ST	
92066-017 X 4 PC	
Z1000(A1/A2)	(78-79)
Z1000A3/A4	(79-80)
Z1000H1	(80)
Z1000D1<Z1R>	(78)
Z900 A SERIES	(76-77)

CSP-402ST	
92066-1011/1111 X 4 PC	
Z400J1/J2	(80-81)
Z500B1-B4	(79-82)
Z550D1<GP>	(81)
Z550H1<GP>	(82)
Z550A1<GPZ550>	(84)
Z550C1/C2	(80-81)
Z650C2/C3	(78-79)
Z650F2/F3	(81-82)
Z650C4	(80)
Z650B1-B3	(77-79)
Z650D2	(79)
Z650D3	(80)
ZX750A1/A2<Z750GP>	(83-84)
Z750R1(GP)	(82)
Z750L1/L2	(81-82)
Z750H2	(81)
ZR750C1 ZEPHYR	(91)
ZR750C1/C2 ZEPHYR	(91-92)
ZX750E1 TURBO	(84)
ZR750C1-C4 ZEPHYR	91-94

PISTON KITS



HONDA

PSK-C50 (GK4)	13101-GK4-760	C-50
PSK-C50	13101-036-010	C-50
PSK-C50B	13101-GB2-000	C-50B
PSK-CB50J	13101-149-000	CB50J
PSK-GLX50	13101-GK4-760	GLX50
PSK-MB50	13101-166-000	MB-50
PSK-MBX50	13120-GE2-000	MBX50/MTX50/NS1
PSK-NH50	13101-GC7-000	NH-50
PSK-PC50	13101-081-000	PC-50
PSK-SK50	13101-GAH-780	SK50
PSK-C70	13101-087-000	C-70
PSK-C70G	13101-GB5-760	C-70G
PSK-C70K1	13101-087-712	C-70K1
PSK-CD70C	13101-126-750	CD-70C
PSK-NH80	13101-GC8-000	NH-80
PSK-ELITE 80	13101-GE1-830	ELITE 80
PSK-DJ1	13101-GN2-870	DJ-1
PSK-C90-2D	13101-GB6-911	C-90 2D
PSK-C90C	13101-GB6-760	C-90C
PSK-CD90	13101-178-000	CD90
PSK-CS90	13101-028-070	CS-90/C-90
PSK-MD90H	13101-121-960	MD90H
PSK-NH90	13101-GW3-020	NH-90
PSK-C100-DREAM	13101-GN5-912	C-100 DREAM
PSK-CD100 SPLENDER	13101-KCC-900	CD100
PSK-CB100	13101-107-760	CB-100
PSK-CB100N	13101-384-000	CB-100N
PSK-MB100	13101-168-000	MB-100
PSK-XL100S	13101-436-000	XL-100S
PSK-CG110	13101-398-000	CG-110
PSK-CT110	13101-439-000	CT-110
PSK-S110	13101-350-010	S-110
PSK-S110-NEW	13101-350-020	S-110 NEW
PSK-CB125T	13101-399-003	CB-125T
PSK-CB125S2	13101-324-680	CB-125S2
PSK-CG125	13101-383-000	CG-125
PSK-CG125-NEW	13101-383-010	CG-125 NEW
PSK-CG125 TITAN	13101-KGA-900	CG125 TITAN
PSK-CG125-TODAY	13101-KY0-890	CG125 TODAY
PSK-XL125S	13101-437-000	XL-125S
PSK-XL2125R	13101-440-000	XL125R
PSK-CD175	13101-313-000	CD-175
PSK-CD185	13101-418-000	CD-185
PSK-XL185S	13101-427-000	XL-185S
PSK-CD195	13101-464-000	CD-195
PSK-XR200	13101-446-770	XR-200
PSK-KX200	13101-KBB-901	KX200
PSK-ELITE-250	13101-KS4-000	ELITE 250
PSK-XL250S	13101-428-000	XL-250S
PSK-XR250R	13101-KV6-000	XR200R
YAMAHA		
PSK-AS1	183-11630-00	AS-1
PSK-AS3	307-11630-00	AS-3
PSK-CE50	27V-11631-00	CE-50
PSK-DT50	353-11630-00	DT-50/RD-50
PSK-DT50LC	5R2-11631-00	DT50LC/RD50LC
PSK-FS1	109-11630-02	FS-1
PSK-PASSOL	2E9-11631-00	PASSOL
PSK-T50	22F-11631-00	T-50
PSK-TOWNY	4J2-11630-00	TOWNY
PSK-YB50	3E1-11631-00	YB-50
PSK-GT80	367-11630-00	GT-80
PSK-T80	22K-11631-00	T-80
PSK-Y80	3E5-11630-00	Y-80
PSK-YB80	298-11630-00	YB-80
PSK-FS80	127-11630-00	FS-80
PSK-YG1	122-11630-00	YG-1/FS-80
PSK-YL2G	166-11630-00	YL2G
PSK-DT100K	23F-11630-00	DT-100K
PSK-DT100X	558-11630-00	DT-100X
PSK-DX100	1X0-11631-00	DX-100
PSK-LS3	382-11630-00	LS-3
PSK-RS100	463-11630-00	RS-100
PSK-RX100	1V1-11630-00	RX-100
PSK-RXS	4X8-11630-00	RX-S
PSK-Y100	2JG-11631-00	Y-100
PSK-YB100	359-11630-00	YB-100
PSK-YB100-10R	5E2-11630-00	YB-100(10R)
PSK-CV50E	5G6-11631-00	CV50E
PSK-JOG50	3CP-11631-00	JOG 50
PSK-NEW JOG	2JA-11631-00	NEW JOG
PSK-LB80	367-11631-00	LB-80

PSK-CV-80	5G3-11631-00	CV80
PSK-YB100-NEW	359-11630-02	YB-100 NEW
PSK-YA90 AXIS	3WF-11631-00	YA-90 AXIS
PSK-BWS100	4VP-E1631-A0	BWS-100
PSK-Y110	3Y4-11631-00	Y-110
PSK-DT125A	444-11630-00	DT-125A
PSK-DT125E	2A6-11630-00	DT-125E
PSK-DT125K	18G-11630-00	DT-125K
PSK-DT125K1	18G-11631-01	DT125K1
PSK-DT125LC	10V-11631-00	DT-125LC
PSK-RD125LC	10W-11630-00	RD-125LC
PSK-RD125C	466-11631-00	RD125C
PSK-RX125 (3M5)	3M5-11630-00	RX-125
PSK-RX125	1V0-11630-00	RX-125
PSK-SR125	25A-11631-00	SR125
PSK-YB125E	372-11630-00	YB-125E
PSK-YB125R	4LS-11631-00	YBR125
PSK-TZR125	2RH-11631-00	TZR-125
PSK-RX135	4Y2-11630-00	RX-135
PSK-DT175	443-11631-00	DT-175
PSK-DT175E	2A7-11630-00	DT-175E
PSK-DT175K	18L-11630-00	DT-175K
PSK-XT225	1KH-11631-00	XT225
PSK-RD250LC	4L1-11630-00	RD-250LC
PSK-RD350LC	4L0-11630-00	RD-350LC
PSK-RD350YPVS	31K-11630-00	RD-350 YPVS

SUZUKI

PSK-AD50M	12110-40D10	AD-50M
PSK-AP50	12110-35000	AP-50 A-50
PSK-FB50-1	12111-09407	FB50-1
PSK-FB50-2	12111-09450	FB50-2
PSK-FR50	12110-35613	FR-50
PSK-FZ50	12110-46103	FZ-50/K-50
PSK-AD60M	12110-29C50	AD60M
PSK-A80	12110-26101	A-80
PSK-DS80	12110-46402	DS-80
PSK-FB80	12111-02A03	FB80
PSK-FR80	12110-25603	FR-80
PSK-FR80-NEW	12110-35623	FR-80 NEW
PSK-RC80	12110-35407	RC-80
PSK-K90	12110-23003	K90
PSK-A100-NEW	12110-12003	A-100 NEW
PSK-A100-OLD	12110-12000	A-100 OLD
PSK-AX100	12110-23401	AX-100
PSK-FB100	12111-30A01	FB100
PSK-FR100V	12110-35630	FR100V
PSK-GP100	12110-39213	GP-100
PSK-GT100	12110-39000	GT-100
PSK-RC100	12110-35503	RC-100
PSK-TS100ER	12110-48101	TS-100ER
PSK-AX110	12110-23450	AX-110
PSK-FD110	12110-30D03	FD110
PSK-RC110	12110-31C00	RC-110
PSK-RU110	12110-21D10	RU-110
PSK-B120	12110-20200	B-120
PSK-GP125	12110-39102	GP-125
PSK-GN125X	122111-05202	GN125X/DR125
PSK-GT125	12110-36207	GT-125
PSK-K125	12110-08402	K-125
PSK-RG125	12110-36A06	RG-125
PSK-TS125	12110-48001	TS-125
PSK-TS125ERZ	12110-48700	TS-125ERZ
PSK-TS125X	12110-01A02	TS-125X
PSK-TS185	12110-29900	TS185/ER/ERT
PSK-B200X5	12110-10203	B-200X5
PSK-GT250X7	12110-11300	GT-250X7
PSK-DR350	12110-14D03	DR350
PSK-TS250ER	12110-30510	TS-250ER

KAWASAKI

PSK-AN80/JOY	13001-1084	AN-80/JOY
PSK-AN80 NEW	13001-1302	AN80 NEW
PSK-AR80H	13001-1326	AR-80H
PSK-AR80K1	13001-1353	AR-80K1
PSK-KX60A	13001-1080	KX60B
PSK-KH100	13001-057	KH-100/G7T
PSK-AM105	13001-1291	AM-105
PSK-KH110	13001-1019	KH-110/GTO 110
PSK-AR125A	13001-1172	AR-125A
PSK-GTO-125	13001-1061	GTO-125
PSK-KE125A	13001-1068	KE-125A
PSK-KMX125	13001-1235	KMX125
PSK-KR150	13001-1352	KR-150
PSK-KE175B	13001-074	KE-175B
PSK-KE175D	13001-1041	KE-175D
PSK-KMX200	13001-1263	KMX200
PSK-KDX200E	13001-1317	KDX200E

CONNECTING ROD KITS



HONDA

STOCK NO	O.E.REF	MODEL
CRK-100D	13201-001-040	C-100D
	13381-001-040	
	13211-001-020	
	91101-001-030(2.5X10)	
CRK-C50	13201-036-010	C-50/70
	13381-035-010(GB1-900)	ST-50/70
	13211-035-000	SS-50
	91101-001-030(2.5X10)	
CRK-C50B	13201-GB2-300	C-50B
	13381-178-300	
	13211-035-000	
	91101-001-030(2.5X10)	
CRK-C50C	13201-GB5-760(GEO-300)	C-50C
	13381-GB1-900(178-300)	C-70C
	13211-035-000 RETAINER	C-90
	91101-001-030 BEARING TYPE	
CRK-C50D	13201-GK4-300	C-50D
	13381-GK4-300	
	91101-GK4-003/300 BEARING TYPE	
CRK-C50E	13201-GK4-760	C-50E/G/H
	13381-GK4-760	
	91101-GK1-003/004 BEARING TYPE	
CRK-MB50	13201-166-310/300	MB-50
	13381-147-300	MB-5
	91001-156-004	MT-50
	91102-156-004 W/WASHER	
CRK-MBX50	13201-GE2-310	MBX50/MTX50
	W/WASHER	
CRK-NH50	13201-GC7-710(147-300)	NH-50
	13381-147-300	NC-50
	91101-122-004	LEAD 50
	91102-GC7-013	DIO 50
CRK-NH80	13201-GC8-300	NH-80
	13381-GC8-300	LEAD 80
	91001-156-004	
	91102-GC8-003/004 W/WASHER	
CRK-C90	13201-028-010	C-90
	13381-028-000	CS-90
	13211-235-000	CT-90
	91101-001-030(2.5X10)	
CRK-C90B	13201-178-300	C-90B
	13381-GB1-900	
	13211-035-000	
	91101-001-030(2.5X10) REAINER TYPE	
	BEARING TYPE	
CRK-C90G	13201-GB5-760(GEO-300)	C-90G
	13381-GB1-900	
	91101-GB4-681	
CRK-C100CM	13201-GF6-300	C-100CM
	13381-GF6-300	C-100EX
	91101-GF6-003	C-100H/M

STOCK NO	O.E.REF	MODEL
CRK-MB80	13201-168-310	MB-80
	13381-168-300	MB-100
	91001-168-004	
	91102-168-003 W/WASHER	
CRK-CB100	13201-107-010	CB-100
	13381-107-300	S-110 OLD
	13211-107-000	
	96220-30100(3X10)	
CRK-CB100K2	13201-107-710	CB-100K2
	13381-324-00	SB-100
	13211-324-000	CL-100K2
	96220-30100(3X10)	
CRK-XL100S	13201-028-010	XL-100S
	13381-436-300	XL-100SZ
	13211-235-000	
	91101-001-030(3.5X10)	
CRK-S110DX	13201-383-310	S-110DX
	13381-350-000	TM-100
	91002-383-003/004	
CRK-CG110	13201-383-310	CG-110
	13381-383-300	CG-125
	91002-383-003/004	CB-100K3
		CB-125S2
CRK-C92	13201-202-020	C-92
	13379-202-330	C-95
	13211-202-010	
	91101-205-010(2.5X8.5)	
CRK-CB125S	13201-324-010	CB-125S
	13381-324-000	CB-125S1
	13211-324-000	CD-125S
	96220-30100(3X10)	
CRK-CD125K3	13201-230-010	CD-125K3
	13379-230-350	CB-125K3
	13211-230-010	CL-125K3
	91101-205-010(2.5X8.5)	
CRK-XL125S	13202-437-300	XL-125S
	13381-383-300	XL-125SZ
	91002-437-004	
CRK-XL125R	13201-440-300	XL-125R
	13381-446-770	XL-125RC
	91002-446-771	XL-200RD
CRK-MBX125/F	13201-KE1-300	MBX125/F
	13381-KK4-300	MTX125R
	91004-KA3-003/004	
	91101-KE1-004/013 W/WASHER	
CRK-XL185S	13202-427-300	XL-185S
	13381-383-300	XL-185SZ
	91002-437-004	XR-200A
CRK-XR250R	13202-KT1-300	XR250
	W/WASHER	XL250

STOCK NO	O.E.REF	MODEL
CRK-XL250S	-428- CON-ROD	XL-250S
	-428- CRANK PIN	
	-428- CRANK PIN BEARING	
CRK-XLR250R	13201-KK1-000 W/WASHER	XLR250R

YAMAHA

CRK-S50	2E9-11651-00	S-50(PASSOL)
	2E9-11681-00	MA-50
	93310-416F7	SA-50(PASSOLA)
	93310-21038	JOG 50
CRK-DT50LC	3R1-11651-00 W/WASHER	DT50LC/RD50LC
CRK-V50 OLD	126-11651-00	V-50 OLD
	257-11681-00	V-75 OLD
	93310-41810	FS1E, V-70
	93310-11202	YB-50
CRK-V50 NEW	517-11651-00	V-50 NEW
	257-11681-00	V-75 NEW
	93310-41810	V-70
	93310-11268	
CRK-YG1D	126-11651-00	YG-1D
	122-11681-01	YF-1
	93310-41810	G1FD
	93310-11202	
CRK-YB80	180-11651-00	YB-80
	122-11681-01	FS-80
	93310-41810	YG-5
	93310-11202	
CRK-DT50	538-11651-01	DT-50/80
	257-11681-00	GT-50/80
	93310-41810	RX-50, RD-50
	93310-11268W./WASHER	LB-50, MR-80
CRK-Y80	1W7-11651-00	Y-80
	174-11681-00	V-80
	93310-420F2	Y-75 NEW
	93310-11268 W/WASHER	
CRK-Y100	2JG-11651-00	Y-100
	2Y1-11681-00	
	93310-42012	
	93310-21403 W/WASHER	
CRK-YB100	164-11651-00	YB-100
	164-11681-00	YL2-G
	93310-42237	YH-3
	93310-21403 W/WASHER	YB-90
CRK-DT100K	1M7-11651-00	DT-100K
	5E2-11681-00	YB-100(10R)
	93310-422E7	RX-100
	93310-21403 W/WASHER	
CRK-DT100X	558-11651-00	DT-100X
	5E2-11681-00	DT-100C, RS-100
	93310-422E7	AG-100, LS-3
	93310-21403 W/WASHER	DX-100
CRK-RS100	304-11651-00	RS-100
	5E2-11681-00	DT-100
	93310-42251	RD-90
	93310-21403 W/WASHER	RS-100P
CRK-RXS100	4X8-11651-00	RXS-100
	3M5-11681-00	RX-S
	93310-42231	RX-115
	93310-214H9 W/WASHER	
CRK-RS125	479-11651-00	RS-125
	248-11681-00	YB-125-2
	93310-42231	
	93310-216A3 W/WASHER	

STOCK NO	O.E.REF	MODEL
CRK-RX125	1V0-11651-00	RX-125/135
	(4Y2-11651-00)	RS-125
	3M5-11681-00	DT-125K
	93310-42231	
CRK-RD125	93310-216J2	W/WASHER
	183-11651-00	RD-125
CRK-RD125-2	122-11681-00	AS-1
	93310-41810	
	93310-11281	W/WASHER
CRK-RD125LC	1E7-11651-00	RD-125-2
	(417-11651-00)	AS-3
	122-11681-00	
	93310-41809	
CRK-SR125	3R2-11651-00	RD-125LC
	3M5-11681-00	RZ-125
	93310-422L1	DT-125LC
	93310-216J2	W/WASHER
CRK-YB125	5N0-11651-00 W/O WASHER	SR125 XT125
	137-11651-00	YB-125
CRK-YZ100C	137-11681-00	YB-125E
	93310-42417	YA-6, YA-7
	93310-21606	W/WASHER
	1G8-11651-00	YZ-100C
CRK-DT125	2K5-11681-00	YZ-125E
	93310-422E6	YZ-125X
	93310-216A3	W/WASHER
	248-11651-00	DT-125
CRK-DT125-2	248-11681-01	AG-125
	93310-42231	
	93310-216A3	W/WASHER
	559-11651-00	DT-125-2
CRK-DT125MX	248-11681-01	DT-125FC
	93310-42231	
	93310-216A3	W/WASHER
	2N4-11651-00	DT-125MX
CRK-TZR125	(2A6-11651-00)	DT-125G
	3M5-11681-00	DT-125E/F
	(248-11681-01)	
	93310-42231	
CRK-XC125	93310-216A3	W/WASHER
	2RH-11651-00	TZR-125
	3F7-11681-00	DT-125R
	93310-523T3	
CRK-RX-Z	93310-316H7	W/WASHER
	55K-11651-00	RX-Z
	55K-11681-00	RX-135Z
	93310-522N3	
CRK-DT175	93310-216L2	W/WASHER
	248-11651-01	DT-175
	248-11681-01	AG-175
	93310-42231	CT-175
CRK-DT175-2	93310-216E1	W/WASHER
	559-11651-00	DT-175-2
	248-11681-01	
	93310-42231	
CRK-DT175G	93310-216E1	W/WASHER
	2N4-11651-00	DT-175G
	(2A6-11651-00)	DT-175M
	3M5-11681-00	DT-175E/F
CRK-RS125	(248-11681-00)	
	93310-42231	
CRK-RS125	93310-216E1	W/WASHER

STOCK NO	O.E.REF	MODEL
CRK-DT175K	4Y2-11651-00	DT-175K/L
	3M5-11681-00	
	93310-422L0	
	93310-216E1	W/WASHER
CRK-RD250	360-11651-00	RD-250
	278-11681-00	RD-350
	93310-42231	
	93310-216A3(RD-250)	W/WASHER
CRK-RD250LC	(4L1-4L2)	RD-250LC
	4L0-11651-03 (W/OUT CRANK PIN)	
	93310-522J0	
	93310-316H7	W/WASHER
CRK-RD350LC	4L0-1651-03 (W/OUT CRANK)	RD-350LC (4L0)
	93310-522J0	
	93310-316H6	W/RZ-350
CRK-DT250E	498-11651-00	DT-250E,M
	275-11681-00	YZ-250(75)
	93310-42451	TY-250J
	93310-21824	W/WASHER
CRK-T50	22F-11651-00	T-50
	22F-11681-02	T-50B/C/D
	93311-32353	
CRK-V90	626-11651-91	V-90
	174-11681-00	
	93310-42012	
	93310-21403	W/WASHER

SUZUKI

CRK-FA50	12161-04001	FA-50
	12211-02300	FZ-50
	09263-15014	FS-50
	09263-12015	
CRK-AY50	12161-04710	AY50 KATANA
	W/WASHER	
CRK-K50	12161-35000	K-50
	12211-13100(16X40)	K-50-1/2/3
	09263-16002	A-50
	09263-12003	
CRK-F50	12161-35000	F-50
	12211-19000(16X44)	FR-50
	09263-16002	K-50-4
	09263-12003	W/WASHER
CRK-A50	12161-35000	A-50
	12211-06100(16X46)	AC-50
	09263-16002	U-50
	09263-12003	W/WASHER AP-50, TS-50
CRK-TS50ER	12161-35000	TS-50ER
	12211-46010 OR 12211-4610	TS-50X F-50
	09263-16016	RG-50E
	09263-12015	W/WASHER RG-50EW GAMMA
CRK-A70	12161-05001	A-70
	12211-05000	A-80
	09263-19007	U-70
	09263-12003	W/WASHER
CRK-FR70	12161-05001	FR-70
	12211-19300	FR-80
	09263-19007	F-70, FR-70N/80N
	09263-12003	W/WASHER FR80M,B FR80-3
CRK-RM80	12161-14001	RM-80
	12211-26400	TS-80ER
	09263-17010	
	09263-12012	W/WASHER
CRK-DS80	12161-14001	DS-80
	12211-46000	DS-80N/C
	09263-17010	
	09263-12003	W/WASHER

STOCK NO	O.E.REF	MODEL
CRK-RC100	12161-35500	RC-100
	12211-35401	RC-80
	09263-20052	RC-110
	09263-12015	W/WASHER
CRK-TS100	12161-25001	TS-100
	12211-25001	TS-90
	09263-19007	
	09263-12003	W/WASHER
CRK-GT100	12161-12002	GT-100
	12211-25001	
	09263-19007	
	09263-14001	W/WASHER
CRK-A100	12161-12002	A-100
	12211-03300	A-100-4
	09263-19007	
	09263-14001	W/WASHER
CRK-GP100	12161-12002	GP-100
	12211-03001	GP-125
	09263-19007	GP-100N/125N
	09263-14004	W/WASHER GT-250X7
CRK-TS100C	12161-12002	TS-100C
	12211-48001	TS-1000ER
	09263-19007	TS-125ER/ERN
	09263-14019	W/WASHER
CRK-GT200X5	12161-12002	GT-200X5
	12211-10302	TR-S, SB-200
	09263-19009	B-200N
	09263-14019	W/WASHER
CRK-AX100	12161-23400	AX-100
	12211-23401	TR-S RACER
	09263-20020	
	09263-14019	W/WASHER
CRK-B100	12161-11001	B-100
	12211-11000	B-120
	09263-20022	B-100P
	09263-14019	W/WASHER
CRK-K125	12161-08002	K-125-2/3/4
	12211-08200	/5/6/7
	09263-20020	
	09263-16003	W/WASHER
CRK-GT125	12161-14001 (W/OUT CRANK)	GS-125/1/2/3
	09263-17010	
	09263-12012	W/WASHER
CRK-TR125	12161-12002	TR-125
	12211-39300	
	09263-19009	
	09263-14012	W/WASHER
CRK-GT185	12161-36100 (W/OUT CRANK)	GT-185
	09263-22009	
	09263-12003	W/WASHER
CRK-RG125	12161-36A10	RG-125 GAMMA
	12211-36A00-0A0	RG-125EW/CF
	09263-22034-0B0	
	09263-14022	W/WASHER
CRK-TS185	12161-93000	TS-185
	12211-29001	TS-185ER/ERN
	09263-22006	
	09263-16005	W/WASHER
CRK-TS125X	12161-39310	TS-125X
	12211-14501	RA-125
	09263-22032	
	09263-14019	W/WASHER
CRK-RG-V	12161-12B01	RG-V
	12211-36A00-0A0	TX-150
	09263-22047-0B0	
	09263-14019	W/WASHER
CRK-GT250A/B	12161-11000	GT-250A/B/M
	12211-18001	
	09263-20020	
	09263-14019	W/WASHER

STOCK NO	O.E.REF	MODEL
CRK-GT250K	12161-18000	GT-250K
	12211-18001	
	09263-20020	
	09263-16005 W/WASHER	
CRK-TS250	12161-16400	TS-250-3/5/12
	12211-16400	TR-250ER
	09263-25008	
	09263-18005 W/WASHER	
CRK-GT380	12161-11001	GT-380
	12211-58000	
	09263-20020	
	09263-14019 W/WASHER	
CRK-TS125ERZ	12161-12002	TS-125ERZ
	12211-48700	
	09269-19009	
	09263-14019 W/WASHER	

STOCK NO	O.E.REF	MODEL
----------	---------	-------

KAWASAKI

CRK-GA1/2/3/4	13044-008	GA1/2/3/4
CRK-GA1B	13044-019	GA1B, GA5
CRK-G7	13044-024/5015 W/WASHER	G-7/S/T KH-100, KE-100
CRK-AN80	13044-5023	AN-80/90 JOY, AX-1
CRK-AR50	13044-5020 W/WASHER	AR-50, AE-50 AR-80, AE-80
CRK-GT0110	13044-5013 W/WASHER	GTO-110 KH-110
CRK-B1	13044-004 W/WASHER	B-1, B1L, B1LP KC-125
CRK-KE125A	13044-5003 W/WASHER	KE-125A, KH-125A
CRK-GT0125	13044-5021 W/WASHER	GTO-125, KH-125D KH-125J
CRK-AR125-A1/A2	13044-5027 W/WASHER	AR125-A1/A2
CRK-AR125C	13044-5044 W/WASHER	AR-125C, A3-A6
CRK-KMX125	13044-5069 W/WASHER	KMX125
CRK-KDX125F	13044-5071	KDX125F KDX200
CRK-AR140	13044-5046 W/WASHER	AR-140, GT-X
CRK-KE175B	13044-039 W/WASHER	KE-175B, KH-175B
CRK-KE175D	13044-5012 W/WASHER	KE-175D, KH-175D
CRK-KZ200	13044-5006 W/WASHER	KZ-200, A-1

CYLINDER HEAD MOUNTING RUBBERS



HONDA

CMR-101ST	
90541-422-000 X 8 PC	
CB900FZ	(79)
CB750FZ	(79)

CMR-102ST	
90541-425-000 X 8 PC	
CB1100R(B-C)	(81-82)
CB1000C	(83)
CB900F(A-C)	(80-82)
CB900C	(80-82)
CB750SC	(82-83)
CB750C	(80-82)
CB750F(A-C)	(80-82)
VT250C(S)	(95)

CMR-103ST	
90541-371-000 X 4 PC	
GL650D(D/2D)	(83)
CX650E(D)	(83)
CX650C	(83)
GL650I(D)	(83)
CX500TC	(82)
CX500D(A)	(80)
GL500I(B/C)	(81-82)
GL500(B/C)	(81-82)
CX500C(A-C)	(80-82)
CX500C	(82)
GL500D	(82)
CX500(A/B)	(80-81)

CMR-105ST2	
90542-MB0-000 X 4 PC	
VT600C SHADOW	(88-89)
VT600C	(94-95)
XRV750L	(90)
NTV750J	(88)
NT650	(88-89)
NTV650(J-M)	(88-91)
XRV650J AFRICA TWIN	(83)
XL600VH TRANSALP	(87)
VT500E(D)	(83)

CMR-105ST	
90542-MB0-000 X 8 PC	
VF1000F(E/F/2F)	(84-85)
VF750C(C-E) MAGNA	(82-83)
VF750F(D-F)	(83-84)
VF750S(C/D) SABRE	(82-83)

CMR-107ST	
90543-MA6-000 X 8 PC	
CBX750F(E)	(84)
CB750F2(N/R/S)	(92,94-95)

CMR-110ST2	
90543-MV9-670 X 6 PC	
CBR900RR(P-S)	(93-95)
CBR600F(N-R)	(92-94)

CMR-110ST	
90543-MV9-670 X 8 PC	
ST1100(A/S)	(95)
CBR1000(P-T)	(93-96)
CB1000FS	(95)

YAMAHA

CMR-201ST2	
2GH-1111G-00 X 4 PC	
XTZ750	(79-90)

CMR-201ST	
2GH-1111G-00 X 8 PC	
(90480-12365/12446)	
FJ1200	(88)
FZR1000	(87-88)
FJ1100	(84-85)
FJ1100L/LC	(84)
FZR1000	(89-90)
XJ900	(83-86)
XJ900(N)	(85)
FZ750(N/S)	(85-86)
FZ750	(88)
FZR750R	(90)
FZR600	(90-91)

CMR-202ST	
4U8-1112G-00 X 8 PC	
+ 4G0-1111G-00 X 4 PC	
XJ750(J/K) MAXIM	(82-83)
XJ750R(H/J) SECA	(81-82)
XJ650(J)	(82)
XJ650(K) MAXIM	(83)
XJ600	(84)
XJ50R(H/J/K) SECA	(81-83)
XJ550(H/J/K) MAXIM	(81-83)

SUZUKI

CMR-301ST	
09161-11006(11008)	
X 8 PC	
GSX1100E	(84-86)
GSXR1100(G)	(86)
GSX1100F(J-S)	(88-95)
GSX1100G(M/N)	(91-92)
GSXR1100(L)	(90)
GSXR1100W(P/R/S)	(93-95)
GSXR1100(K)	(89)
RF900R(R/S/S2)	(94-95)
GSXR750(X/G)	(86)
GSX750W(N/P/R/S)	(92-95)
GSX750F(K-P)	(89-93)
GSXR750(F/G)	(85-86)
GSX600F(J-N)	(88-92)
RF600R(U)(P/R/S)	(93-95)

CMR-303ST	
09280-15006 X 4 PC	
GS500E(K/L/M/N)	(89-92)

KAWASAKI

CMR-401ST	
92055-1225 X 4 PC	
KL650B-1B3<TENGAI>	(89-91)
KL650A6<KLR650>	(92)
KL650A1<KLR650>	(92)
EX500A1-A6	(87-92)
EN500A1-A3	(90-92)
EX500B1-B4<GPZ500S>	(88-92)
ZX400L1/L2	(91-92)
KL250D11<KLR250>	(94)
EX250E1/E2	(86-87)
EL250E1/E2	(91-92)
EX250F6	(92)
EX250H1-H5	(90-94)
EL250D4/D5	(93-94)

CMR-401ST2	
92055-1225 X 6 PC	
ZX1000A1/A2	(86-87)
ZX900A1/A2<GPZ900R>	(84-85)
ZX750G2<GPZ750R>	(85)
ZX600C3-C5	(90-92)
ZX600A1<GPZ600R>	(85)

CMR-402ST	
92055-1352 X 6 PC	
ZX1100D1-D3<ZZR1100>	(93-95)
ZX1100C1-C3<ZZR1100>	(90-92)
ZX1100E1<GPZ1100>	(95)
ZX1000B1<ZX10>	(88)
ZX900B1/B2	(94-95)
ZX750K1	(91)
ZX750J1<ZXR750>	(91)
ZX600F1	(95)

CMR-402ST2	
92055-1352 X 8 PC	
ZR1100	(92-93)
ZX600D2/D3	(91-92)
ZX600E1/E2<ZZR600>	93-94

**CLUTCH MASTER
CYLINDER PUSH ROD
& BUSHING**



MS-900	
22884-MB0-006	
22885-MB0-006	
59871-08A00	
59892-08A00	
13116-1110	
92028-1310	
HONDA	
VF500C	84-85
VF500F	84-86
CB550SC	83
CB650SC	83-85
CB700SC	84-86
VF700C	84-87
VF700F	84-85
VF700S	84-85
VFR700F/F2	86-87
VT700C	84-87
VF750C	82-83
VF750C	88
VF750F	83-84
VF750S	82-83
VFR750F	86
VFR750F	90-97
VFR750R RC30	90
VT750C	83
PC800	89-90
PC800	94-98
VT800C	88
CB1000	94-96
CBR1000F	87-88
CBR1000F	90-91
CBR1000F	93-96
VF1000F	84
VF1000R	85-86
VTR1000F	98-99
ST1100	91-95
ST1100A	92-99
CBR1100XX	97-99
VF1100C/S	84-85
VT1100C	85-90
VT1100C	92-97
GL1500	88-99
SUZUKI	
GSX-R750G/H	86-87
GSX-R1100	86-98
GSX1100F	88-93
GV700GLF	85
GV1200	85-86
GV1400	86-88
RF900R	94-97

KAWASAKI	
ZX750F1-F4	87-90
ZX750H1/H2	89-90
ZX750J1/J2	91-92
ZX750K1/K2	91-92
ZX750L1-L3	93-95
ZX750M1/M2	93-94
ZL900A1/A2	85-86
ZX900A1-A3	84-86
ZX900B1-B4	94-97
ZG1000A1-A15	86-00
ZL1000A1	87
ZX1000A1/A2	86-87
ZX1000B1-B3	88-90
ZR1000A1-A4	92-95
ZX1100C1-C4	90-93
ZX1100D1-D7	93-97
ZX1100E1-E3	95-97
ZG1200A1/B1-B14	86-00
VN1500A1-A12	87-98
VN1500B1-B4	87-90

**CARB RUBBER
PASSAGE PLUGS**



HONDA	
CPP-101	
16010-371-004	PLUG
GL1000	75-79
GL1000 LTD	76
CPP-102	
16010-425-671	PLUG
16010-461-781	PLUG
16010-469-004	PLUG
CB750C	80-81
CB750F	79-82
CB750K	79-82
CB750L	79
CB900C	80-82
CB1000C	83
CBX	79-82
CB900F	79-82

SUZUKI/YAMAHA	
CPP-901	
13357-44080	
3F7-14991-00	
GN125Z/D	82-83
GN125E	92-95
GN400	80-82
GS450ED	83
GS450GAZ/GAD	82-83
GS450GAF	85
GS450LD	83

CPP901(Cont)	
GS450LF/LG/LH/LJ	85-88
GS450TD	83
GS550ET	80
GS550LT/LX/LZ	80-82
GS550MZ KATANA	82
GS550TX	81
GS650EX/EZ	81-82
GS650GX/GZ/GD	81-83
GS650GLX/GLZ/GLD	81-83
GS650MD KATANA	83
GS700EF/ESF	85
GS750ET/EX/EZ	80-82
GS750ED/ESD	83
GS750LT/LX	80-81
GS750SD KATANA	83
GS750TZ/TD	82-83
GS850GT/GX/GZ/GI	80-83
GS850GLT/GLD	80-83
GS1000GT/GX	80-81
GS1000ET/ST	80
GS1000SZ KATANA	82
GS1100ET-ESD	80-83
GS1100GZ/GLD	82-83
GS1100GKZ-GKE	82-84
GS1100LT	80
GS1100SD KATANA	83
GS1150ES3-EF2	83-85
GS1150EG/ESG	86
XS650G/H	80-81
XS650SG/SH	80-81
XS650SJ/SK	82-83
XS1100G/H	80-81
XS1100LG/LH	80-81
XS1100SG/SH	80-81

**SWING ARM
BRONZE BUSHINGS**



GBS101	
SAH500	
52109-357-310	
XL250S	
XL500S	
XR500	
GBS102	
SAH750	
52108-300-300	
CB500/K1-K2	
CB550/K1	
CB750/K1-K6	

GBS103	
SAH750N	
52108-457-300	
CBX	79
CB750/F	76-78
CB550	76-78
CB550F/500T/400F	
CB/CL450	
XL350	76-78
CR250/M1	
MR/XL250	
MT250K1	
XL175	
XL175K1-K2	
CB360T	
CJ360	
GBS201	
SAY029	
XS650/500/400	
GBS203	
SAY028	
DT175/125A-F	
GBS301	
SAS002	
09307-22002	
GT750/550/500	
GT380/250	
RE5	
RL250	
TM400/250	
TS400/250	
T500/350/250	
GBS401	
SAY018	
KAWASAKI	
33033-009	
KZ900/750T/650	
KZ400/200	
Z1/A/B	
H1/2	
KH500/400/250	
KE250/175/125	
KL250	
KD175/125	
KS125A	
G4	
F6/7/8/9/11	
YAMAHA	
90386-22018	
RD400/350/250	
RD350LC/250LC	

EXHAUST PIPE GASKETS

DIFFERENT FROM O.E.M
NON-ASBESTOS



HONDA			
EPG-101C	CB360/G/T	74-76	
	GL500(B/C)	81-82	
	GL500B/C	81-82	
	CX500G(A)	80	
	CX500G(B-C)	81-82	
	CX650C	83	
	GL650/I SILVERWING	83	
	GL1100C/IG/DC/AC	82	
	GL1100A/IA/DA	80	
	GL1200E/DE/IE/AE	84	
	GL1200/A/L/SEI	84-87	
	EPG-103C	XL250K/K1/K2	72-75
		CB250N/NA/NB	79-81
CB250ND (C)		82	
CB350G		73	
SL350K2		72	
CB400N (C)		82	
CM400A(A)		80	
CB400F CB1		89-90	
CM400A(Z)		79	
CB400T(A/B/C) HAWK		80-81	
CB400T1/T2 HAWK		78-79	
CB400N/NA		79-80	
CB450SC NIGHTHAWK		82-86	
CB450T		82	
CM450A/C/E		82-83	
CMX450C REBEL		86-87	
CBR500F(H-K)		87-89	
CBR600F(H-K)		87-89	
VT500C SHADOW		84	
VT500FT ASCOT		83-84	
VT500E(D)		83	
VT500C(D)		83	
CX500/Z		78-79	
CBX550FC/F2C		82	
CB550SC NIGHTHAWK		83	
CBR600F HURRICANE		87-90	
VT600C(J/K)		88-89	
XL600V TRANSALP		87-94	
CB650		79-82	
CB650SC		83	
NT650 HAWK GT		88-89	
XR650J/K		88-89	
NTV650J/K/L		88-90	
CB650SC(C) NIGHTHAWK		82	
CBX650E(D)		83	
CB650C		80	
XR650L		90	
VT750C MAGNA		94-95	
CBR900RR(M-S)		91-95	
VF1000R		85-86	
VF1000F(F)		85	
VF1000F2(F/G) BOLD'OR		85-86	
VF1000F(E) INTERCEPTOR		84	
VF1100C MAGNA		83	
ST1100L-S		90-95	
VF1100S V65 SABRE		84-85	
EPG-104C		XR80	79-84
	XL80S	80-85	
	XR80R(H)	87	
	XR80R(L/M)	90-91	
	XL100S	79-85	
	XR100R	85-88	
	XR100	81-84	
	CB350F/F1	72-74	
	CB400F	75-77	
	EPG-106C	CBF250	04
CRF250R(4-6)		04-06	
CRF250X(4-6)		04-06	
NX250(J/K/L/M)		88-91	
NX250P		93	
NX2502P		93	
NV400CS		95	
NV400CV		97	
FT500 ASCOT		82-83	
NTV600J/K		88-89	
NTV600M		91	
NV600CP/CR		93-94	
VT600C(J-X)		88-89	
VT600CD(P-X)		93-99	
VT600CD2X		99	
NT650V(W-5)		98-05	
NTV650J/K/L/M		88-91	
NTV650P		93	
NTV650S/T/V		95-97	
XL650V(Y-6)		00-06	
XR650M/N		91-92	
CB750SC NIGHTHAWK		82-83	
CB750F1/F2		77-78	
CB750A AUTOMATIC		78	
CB750FZ/FA/FB/FC/F2C		79-82	

EPG-106C	CB750C CUSTOM	80-82
	CB750K1-K7	73-79
	GBX750FE	84
	CBX750PH	87
	CBX750P2H	87
	CBX750P2L	90
	NV750C2X	99
	VT750C1	01
	VT750C2(V-1)	97-01
	VT750C3(Y-1)	00-01
	NV750C21	01
	VT750C(V-Y)	97-00
	VT750C4/C5/C6	04-06
	VT750CA5/CA6	05-06
	VT750CD3(Y-1)	00-01
	VT750C2	02
	VT750DCA3	03
	VT750DCB3	03
	CB900FB	81
	CB900C CUSTOM	80-82
	CB900FZ/FA	79-80
	CB900FC/F2C	82
	CB900F2B	81
	CBR900RE1	01
	CBR900RR(Y-3)	00-03
	CB1000F(P-T)	93-96
	CB1000FS	95
	CB1100R(B)	81
	CB1100F(D) SUPERSPORT	83
	CB1100R(D)	83
	CB1100R(C)	82
	CBR1000F(H-V)	87-97
	CBR1000FX	99
CB1300	05	
CB1300A5	05	
CB1300F13	03	
CB1300F3	03	
CB1300S5	05	
CB1300SA5	05	
EPG-109C	GA125S/T/V/W/X	95-99
	SL100K/K1	74-75
	SL100K/K1	70-71
	SL100K1-K3	71-73
	CL100S-S3	71-73
	TL125K/K1/K2	73-75
	SL125K1/K2	71-73
	CB125S	76
	CB125S-S2	73-75
	CB125TDJ	88
	CB125T	90
	CB125TP	93
	CB125S	78-82
	CBR125R4/R5	04-05
	CBR125R5/RS6	05-06
	CBR125RW5/RW6	05-06
	CG125P	93
	CG125S/T	95-96
	CG125W/X/Y/1	98-01
	CG125ES4	04
	CL125S	73-74
	CLR125W	98
	CM125CH	87
	CM125CJ	88
	CM125C(M/N/P/R)	91-94
	CM125CX	99
	NX125	88-90
NX125S	95	
NX125V	97	
TL125J	88	
VT125C1	01	
VT125C2(Y/1)	00-01	
VT125C(X/Y)	99-00	
VT125C3/C4	03-04	
VT125C6	06	
XL125	76-78	
XL125K1	74-75	
XL125S	79-82	
XL125S	84-85	
XL125SH	87	
XL125SL-DK	90	
XL125V(1-6)	01-06	
EPG-109C	XR125RW	98
	XR125L(3-6)	03-06
	XL185S(H-N)	87-92
	CM185T	78-79
	XL185SL	90
	XL185SP	93
	XR185	79
	XL200R(D)	83
	CM200T(A/B)	80-81
	CMX250C(T-3)	96-03

EPG-109C	XR200R PRO-LINK	81-83
	XR200R(H-2)	87-02
	CD250U(J-K)	88-89
	CB250RS(A)	80
	CB250M/N/P/R	91-94
	CB250T	96
	CB250W/X/Y/1	98-01
	CB250P4/P5	04-05
	CM250C	83
	CM250C(C)	82
	XL250RC	82
	CMX250C/CD REBEL	86-87
	XR250R	81-82
	XLX350RJ	88
	XR350R	83-85
	XR350R(F/G/H)	85-87
	VFR400R3(L/M)	90-91
	XR400R(T-4)	96-04
	NX500(J-X)	88-89
	VF500C MAGNA	84-85
	VF500F INTERCEPTOR	84-85
	XR500H	87
	XR500S(H/J)	87-88
	XR500R	81-84
	XL500S/SA	79-80
	GB500	89-90
	CB550K	74-78
	CB550F SUPERSPORT	75-77
	XL600R	83-87
	XL600LMF/RMG	85-86
	XR600R(F-Y)	85-00
	FMX650(5/6)	05-06
	FX650(X/Y)	99-00
	NX650(J-X)	88-89
	NX650 2L	90
	XR650R(Y-6)	00-06
	VFR700F/F2 INTERCEPTOR	86-87
	VF700C MAGNA	85-87
	VF700S SABRE	84-85
	RVF750RR/RS	94-95
	SLR650V/W	97-98
	VFR750F(H-V)	87-97
	VFR750R(J-L)	88-90
VF750S V45 SABRE	82-83	
VFR750R/RK	88-89	
VF750F(D/E)V45 INTERCEPTOR	83-84	
VFR750F(J/K)	88-89	
VF750C V45 MAGNA	88	
VFR750F(G/H)	86-87	
VF750C(D/E) V45 MAGNA	82-83	
VFR800 2-6	02-06	
VFR800A2-A6	02-06	
VFR800F(W-1)	98-01	
GL1500A(M-Y)	91-00	
GL1500C1/C2/C3	01-03	
GL1500CD1/CD2/CD3	01-03	
GL1500CT(V/W/X/Y)	97-00	
GL1500C(V/W/X/Y)	97-00	
GL1500SE(M-Y)	91-00	
GL1500J/K/L GOLDWING	88-90	
GL1800A(1-5)	01-05	
GL1800	06	
EPG-112C	CRM75R(K/L/M)	89-91
	SA75K	89
	SA75M	91
	SA75P	93
	MTX80RS(D/E)	83-84
	MBX80SW(D)	83
	MB80S(A)	80
	MTX80C(C)	82
	MT80S(A)	80
	MBX80SW2(D/F/H)	83-87
MBX80SWDD(F/H)	83-87	
H100SJ	88	
EPG-126C	XL350/K1	74-75
	XL350	76-78
	GL450K5-K6	72-73
	CB450K5-K7	72-74
	VT750C(D) SHADOW	83
	PC800K/L	89-90
	VT800C SHADOW	88
	VTR1000F(V-3)	97-03
	VTR1000F(5-6)	05-06
	XL1000V(X-Y)	99-00
XL1000V(1-6)	01-06	
XL1000VA(4-6)	04-06	
VT1100C(H/J)	87-88	
VT1100C(R-S)	94-95	
VT1100C SHADOW	85	
VT1100C SHADOW	87-89	
VT1100C2(1-5)	01-05	

EPG-130C	VT1100C2Y	00	
	VT1100C(N-W)	92-98	
	VT1100C3(1-2)	01-02	
	CRF80F(4-6)	04-06	
	CRF100F(4-6)	04-06	
	XR80R(L-3)	90-03	
	XR100R(L-4)	90-04	
	XR250R(L-4)	90-04	
	EPG-131C	C50J	88
		C50N	92
ST50(J/K/L)		88-90	
Z50A(K5-K9)		75-79	
Z50R(Z-G)		79-86	
Z50J(J-N)		89-92	
ST70(K/L)		89-90	
C90		92	
CT110K		89	
CT110M		91	
XL250S(A/B)		80-81	
XR250		79-80	
XL250S(Z)		79	
C50N/P		92-93	
C50S(N/P)		92-93	
C50ST		96	
C50SWR		94	
C50T		96	
C50Z2P		93	
CRF50F(4-6)		04-06	
ST50N		92	
ST50R		94	
ST50T		96	
XR50R(Y-3)		00-03	
Z50J(N/P)		92-93	
Z50JT		96	
CRF70F(4-6)		04-06	
C70GWR		94	
C70ZP		93	
ST70K		89	
ST70N		92	
ST70R		94	
ST70T		96	
XR70R(V-3)		97-03	
C90CWR		94	
C90CWV		97	
C90MP		93	
C90MT		96	
C90P		93	
C90ST2		02	
C90STR		94	
C90ST(W/X/Y)		98-00	
C90T		96	
C90Z(N/P)		92-93	
CT110P		93	
ANF1253		03	
ANF125(5/6)		05-06	
ANF125T(5/6)		05-06	
EPG-132C		CRF450R(2-6)	02-06
		CRF450X(5-6)	05-06
	YAMAHA		
EPG-201C	TTR-230	05-06	
	XT250	80-87	
	XS400R/RK SECA	82-83	
	XS400DOHC	82-87	
	XS400J/K MAXIM	82-83	
	XV500	83	
	XV500K VIRAGO	88	
	XV535E/EC/F/FC/G/GC	93-95	
	XV535SE	88	
	XV535H/N	89-90	
	XV535	91-99	
	XV535S(F/G/H/J)	94-97	
	XS750	78	
	TX750A	73-74	
	XS2-D	77	
	XS750D/E/F	77-79	
	XS750SE	78	
	XS850	80	
	XS850G	80	
	XS850H	81	
	XS850L(G/H)	80-81	
	XS850SH	81	
	XS850S(G/H)	80-81	
	EPG-201C	FJ1100	84-85
		XS1100	80-81
		XS1100E/F/G	78-80
		XS1100L	80
XS1100H		81	
XS1100LH		81	
XS1100S		81	
XS1100S(F/G)		79-80	
XJ1100J		83	
FJ1200A		91-94	
FJ1200		86-93	
EPG-202C		XS360G/D/2D	76-77
		XS400SG/SH/SJ	80-82
	XS400D/E/F/G/H	77-81	
	XS400E/2F	78-79	

EPG-204C	RD50M	80
	RD50M	82
	DT50MX	82
	DT50R	89-94
	FS1DX	75-76
	DT50MX	86-87
	RD50DX	75-77
	DT80MXS	84
	DT80H/J/K	81-83
	DT80MX	81-82
EPG-207C	RD80MX	81-82
	RD125DX	75-77
	RD200	75
	DT125LC	82
	DT125E	76-79
EPG-208C	DT125R	91-94
	DT175MX	78-81
	RD350	75
	RD350/A/B	73-75
	RD500LC	84-85
	FZR400	88-90
	XT550 (5Y5)	82-83
	XT550J/K	82-83
	XT600Z	83-90
	XT800EN	90-93
EPG-209C	XT800E	94
	FZR600N	89-93
	XT800EH	90-93
	FZ6	04-06
	FZR600R(B-L)	91-99
	FZR600H,M	89-93
	FZR600W	89
	FZR600AC	90
	XT600S/T/U	86-88
	XT600N	89
EPG-211C	SRX600S/SC	86
	XT800H	89
	FZR1000	87-94
	FZR1000(T-G)	87-95
	GTS1000A(E/F)	93-94
	RD250LC	80-82
	RD350LC	80-82
	XJ600 SECA II	93-95
	TTR125/L	00-06
	XT250L/LC	84
EPG-212C	XT350	91-94
	XT350B/BC/D/DC	91-92
	XT350T/TC/U/UC	87-88
	XT350W/WC/A/AC	89-90
	XT350E/EC/F/FC/G/GC	93-95
	XT350N	86-88
	XV535T/U	87-88
	XV535A	90
	XV535(E-L)	93-99
	XV535S(F/G/H/J)	94-97
	XJ550H/J/K	81-83
	XJ550RH/RJ/RK SECA	81-83
	XJ550	81
	ZX550	82
	XZ550R/RK VISION	82-83
	XJ550	83
	FJ600L/LC/N/NC	84-85
	FZ600S/SC/T/TC/U/UC	86-88
	XJ600	84
	XJ600H	89-91
	XJ600N	89-91
	XJ650 11R,4KO	82
	XJ650 4K,11N	80-82
	XJ650 27F,4KO	83
	XJ650 27G,4KO	83
	XJ650LJ/LK SECA	82-83
	XJ650LH MIDNIGHT MAXIM	81
	XJ650RJ SECA	82
	XJ650G/H/J/K MAXIM	80-83
	XS650LK	83
FZ700T	87	
FZX700S/T FAZER	86-87	
FZ750U/UC	88	
FZ750	85-94	
FZ750RT/RU	87-88	
FZ750N/S/SC	85-86	
FZR750RT/RU	87-88	
XJ750H/J/K MAXIM	81-83	
XJ750 RJ/RK SECA	82-83	
XJ750	84	
XJ900F	85-94	
XJ900RK SECA	83	
XJ900	83-84	
EPG-213C	DT80LCII	85-94
	RD80LCI	82
	RD80LCII	83-86
EPG-213C	XV700(L-CS)	84-86
	XV750 VIRAGO	88-92
	XV750 H/J/K VIRAGO	81-83
	XV750SE	81-82
	XV750(A-J)	90-97
	XV920 VIRAGO	82-83
	XV920RH/RJ	81-82
	XV1000	81-82

EPG-213C	XV1000(L/N)	84-85
	XV1000SE	86-88
	XV1000SE	83
	XV1100 VIRAGO	84-85
	XV1100 VIRAGO	86-92
	XV1100(S-L)	86-99
	XV1600	99-03
	XV17	04-06
	XV1700	02-03
	XV19	06
EPG-216C	TZR250	87-90
	TDR250	88-90
	RD350LC YPVS	83-84
	RD350LCF H/N	88-90
	RD350LCH	86-90
	RD350LC YPVS	85
	RD350LCN	86-90
	XT500G/D/E/F/G/H	76-81
	SR500	87-88
	SR500	91-94
EPG-220C	XT500	78-83
	SR500	78-82
	XT500	86-89
	SR500E/F/G/H	78-81
	XS1/1B/2	70-72
	XS650(B-H)	75-81
	XS650S(E-K)	78-83
	XS650-2F	79
	TX650/A	73-74
	XVZ12 VENTURE ROYALE	83-85
EPG-231C	XV12 V-MAX	85-95
	XV13ATKC	98
	XVZ13 VENTURE ROYALE	86-93
	XVZ13 ROYAL STAR	96-06
	YZF450	03-06
	WR450F	03-06
	TTR-50/E	06
	TTR-90	00-06
	YZ250F	01-06
	WR250F	01-06
EPG-232C	SUZUKI	
	GT250K/L/M/A/B	73-77
	SP370C/N	78-79
	DR400T	80
	GS400C	78
	GN400TX/TZ	81-82
	GS400X(B/C)	77-78
	GN400T/XT/XX	80-81
	GS400B	77
	GS400C/EC/N/EN	78-79
GS425E(N)	79	
GS425N	79	
GS425L(N)	79	
GS450L(T/X)	80-82	
GS450L(Z)	82	
GS450S(T/X)	80-81	
GS450GAZ(D/F)	82-85	
GS450L(F/G/H)	85-87	
GS450LD/LF-LJ	83-88	
GS450ET/EX/EZ/ED	80-83	
GS450TX(Z/D)	82-83	
GS450T(X/Z)	81-82	
DR500S(X/Z)	81-82	
GS500E(U) K/L/M/N/P/R	89-94	
DR500X/Z/D	81-83	
DR650RE(U)/R/S	94-95	
DR650S(L/M/N/P)	90-93	
GS750E(C/N)	78-79	
GS750SD KATANA	83	
GSX750(T/X)	80-81	
GSX750S(Z)	82	
GS750LN	79	
GS750D(B/C/N)	77-79	
GS750LT/LX	80-81	
GSX750LT/LX	80-81	
GS750N/EN/ET	79-80	
GS750B/C/N	77-79	
GS750TZ/TD	82-83	
GSX750E(T/X/Z)	80-82	
GS850GZ/GLZ/GD/GLD	82-83	
GS850G(E/F/G)	84-86	
GS850G(N)	79	
GS1000C/EC/N/EN/ET	78-80	
GS1000H(C/N/T)	78-80	
GS1000SZ	82	
GS1000LN	79	
GS1000GT/GLT/GX/GLX	80-81	
GS1000SN/ST	79-80	
GS1100ET/EX/EZ	80-82	
GS1100GZ/GLZ/GD/GLD	82-83	
GS1100LT	80	
GS1100SD KATANA	83	
GS1150ES3/ESE/EF/ESF	83-85	
EPG-302C	GT50(N)	79
	TS50ERK(N/T/X)	79-81
	GT50U(B/N)	77-79
	GT50(B)	77
	GT50E(N)	79

EPG-302C	GT185(K/L/M/A/B/C)	73-78	
	GSX250T/ET/X/EX	80-81	
	GS550ED/ESD/EF	83-85	
	GS550ESF/ESG	85-86	
	GSX800FJ-FM KATANA	88-91	
	DR650RSU(L/M)	90-91	
	GS650GLX/GLZ/GLD	81-83	
	DR650RU(L/M/N/P/R)	90-94	
	GS650EX/EZ	81-82	
	GR650X(D/E/F)	83-85	
	GS650GX/GZ	81-82	
	DR650RSE(M/N/P)	91-93	
	DR650R(L/M/N/P/R)	90-94	
	DR650RSEU(M/N/P)	91-93	
	GS650MD KATANA	83	
	GR650(D/E)	83-84	
	GSXR750X(G/H)	86-87	
	GSX750ES(D/F/G)	83-86	
	GS750ED/ESD	83	
	GSXR750(G/H)	86-87	
	GSXR750R(G)	86	
	GSX-R1100G/H/J	86-88	
	EPG-308C	GN250F	85
DR250S(F/G/H)		85-87	
SP250Z/D/F		82-85	
DR250S(E)		84	
GN250J		88	
DR250(Z/D)		82-83	
GN250Z/D		82-83	
DR250S(Z)		82	
GS550D(T)		80	
GS550(B/C/N)		77-79	
GS550(C/N)		78-79	
GS550LN/LT/LX/LZ	79-82		
EPG-309C	DR-Z125/L	03-06	
	GSX750FK-FS KATANA	89-95	
	GSXR750(J/K/L/M/N)	88-92	
	GSX1100FK/FL/FM	89-91	
	GSX1100F(N/R)	92-94	
EPG-310C	GSX1100G(M/N/P/R)	91-94	
	BOULEVARD S40	05-06	
	LS650P SAVAGE	95-04	
	VS750GLP(G/H/J/K/L/M)	86-91	
	VS750GLF(G/H/J/K)	86-89	
	BOULEVARD S50	05-06	
	VS800GL INTRUDER	92-04	
	VX800L/M/N/P/R	90-94	
	VX800J(L/M/N/P/R)	90-94	
	BOULEVARD S83	05-06	
EPG-311C	VS1400GLP INTRUDER	87-04	
	RM85	02-06	
	DR350(P/R/S)	93-95	
	DR350SE(R/S)	94-95	
EPG-321C	GSX-R1100M/N	91-92	
	DR-Z400E	03-04	
	DR-Z400SM	05-06	
EPG-401C	KAWASAKI		
	ZX750F1-F4 NINJA	87-90	
	ZXR750H1/H2	89-90	
	Z1/A/B	73-75	
	KZ900B1 LTD	76	
	KZ900A4	76	
	KZ1000A3-A4	79-80	
	KZ1000G1 LTD CLASSIC	80	
	KZ1000D1 Z1R	79	
	KZ1000D3 Z1R	80	
	KZ1000B1-B4	77-80	
	KZ1000M1/M2 CSR	81-82	
	KZ1000J1-J3	81-83	
	KZ1000A1-A2	77-78	
	KZ1000R1/R2 REPLICA	82-83	
	KZ1000 MKII	79	
	KZ1000E1/E2 SHAFT	79-80	
	KZ1000K1/K2 LTD	81-82	
	KZ1100L1 LTD	83	
	KZ1100B1/B2 GPZ	81-82	
	KZ1100A1-A3 SHAFT	81-83	
	KZ1100D1/D2 SPECTRE	82-83	
	ZN1100B1/B2 LTD	84-85	
	ZX1100A2 GPZ	84	
	ZX1100A1 GPZ	83	
	ZG1200A/B VOYAGER	86-83	
	EPG-404C	KZ200A1	77
		KLX250A1-A2	79-80
		EL250E1-E4<EL250>	91-94
		KL250A1/A2	78-79
		EL250D1-D5 <EL250>	90-94
		EX250F6/F7/F9<GPX250R>	92-95
		KZ250L1/W1 CSR/LTD	82
		Z250C1	80
		EX250E1/E2	86-87
		KZ305A1/A2/B1 CSR	81-82
		EX305 B1 GPZ	83
KZ305B2/B3		87-88	
KZ550A1-A4		80-83	
KZ550C1-C4		80-83	
KZ550B1/B2		79-80	
ZR550B1-B4 ZEPHYR		90-94	
ZX550A1/A2		84-85	

EPG-404C	KZ550D1 GPZ	81
	ZX600C1/C2/C3	88-90
	ZL600A1/A2 ELIMINATOR	86-87
	ZX600B1 NINJA	87
	ZX600A1-A5A <GPZ600R>	85-89
	KZ650E1/F1 LTD	80
	KZ650B3	79
	KZ650C2-C3	78-79
	KZ650B1-B2	77-78
	KZ650D1/D1A/D2 SR	78-79
	KZ650H1-H3	81-83
	KZ700A1	84
	KZ750E2-E3	81-82
EPG-404C	KZ750F1 LTD	83
	ZX750A3 GPZ	85
	KZ750E1	80
	KZ750L1-L4	81-84
	ZR750C1-C4	91-94
	ZR750-F2	00
	KZ750R1 GPZ	82
	KZ750H1-H4 LTD	80-83
	ZX750A1/A2 GPZ	83-84
	Z1300A1-A5	79-83
EPG-405C	ZG1300A1	84
	KZ1300B2	80
	ZN1300A1-A6	83-87
	ZG1300A2-A5	86-89
	KZ400S/S2/S3	75-77
	KZ400B1/B2	78-79
	KZ400G1	79
	KZ400H1 LTD	79
	KZ400D/D3/D4	75-77
	KZ440H1-H2	82-83
EPG-411C	KZ440B1/B2	80-81
	KZ440G1	82
	KZ440D1-D5 LTD BELT	80-83
	KZ440A1-A4 LTD	80-83
	KE125A3-A8	76-81
	EN450A1-A6	85-90
	EX500DA/D2	94-95
	EX500A1-A7	87-93
	EN500A1-A4 VULCAN	90-93
	EX500B1-B4 <GPZ500S>	88-91
EPG-412C	H1B 500	72
	KLE500A1-A4	92-94
	KZ750B1-B3	76-78
	KZ750G1 LTD	80
	KZ750K1 LTD	83
	KZ750K2 LTD	84
	KZ750M1 CSR	82
	ZX900A1-A2 NINJA<GPZ900R>	84-85
	ZL900A1/A2 ELIMINATOR	85-86
	ZX900A3 NINJA <GPZ900R>	86
EPG-413C	ZX1000A1/A2 NINJA	86-87
	GPZ1000RX A1-A2<ZX1000A>	86-87
	ZL1000A1 ELIMINATOR	87
	ZL1000A1/A2	87-88
	ZG1000/A9<1000GTR>	94
	ZX1000B1-B3<ZX-10>	88-90
	ZX1100D1-D2<ZZR1100>	93-94
	ZX1100C1-C3<ZZR1100>	90-92
	ZX750L1-L3	93-95
	ZX750K1/K2	91-92
EPG-420C	ZX750J1/J2 NINJA	91-92
	ZX750M2	94
	ZX900B1/B2 NINJA<ZX-9R>	94-95
	ZX-10R ZX1000-C1	04
	ZX-10R ZX1000-C2	05
	ZX-10R ZX1000D6F	06
	ZX600E1/E2 <ZZ-R600>	93-94
	ZX600D1/D2/D3	90-92
	ZX600F1 NINJA <ZX-6R>	95
	NINJA650R EX650A6F	06
VULCAN900 VN900D6F	06	
ZX-14 ZX1400A6F	06	

RADIATORS

FOR HONDA

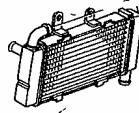

**TOUR
MAX**
IS PERFORMANCE EQUIPMENT

MC ID	MODEL	YEAR
RAD-101	ST1100	93-02
	ST1100A	92-02
	ST1100P	93-96
	ST1100P	2000
RAD-102	CBR600F	95-98
	CBR600F3	95-98
	CBR600FS	95-98
RAD-103-LH	VFR800FI	98-00
RAD-103-RH	VFR800FI	98-00
RAD-104	CBR600F	01-04
	CBR600F4	01-04
RAD-105-LH	VFR800	01-06
	VFR800A	01-06
RAD-105-RH	VFR800	01-06
	VFR800A	01-06
RAD-106	CB900F HORNET	02-06
RAD-107	CBR600F	91-94
RAD-108	CBR900RR	92-95
RAD-109	CB1000F	93-96

MC ID	MODEL	YEAR
RAD-110	VFR750F	94-97
RAD-111-LH	VTR1000F	97-02
RAD-111-RH	VTR1000F	97-02
RAD-112-RH	XL650V TRANSAL	00-06
RAD-112-LH	XL650V TRANSAL	00-06
RAD-113	CB500	94-02
	CB500S	98-00
RAD-114	CBR1000F	92-99
RAD-115	CBR900RR	96-97
RAD-116	VT600C	91-97
	VT600CD	93-98
RAD-117	CBR900RR	00-01
RAD-118	CBR900RR	2月3日
RAD-119	CBR600F	99-00
RAD-120	CBR600RR	03-04
RAD-121	CB600F	98-99
RAD-122	CB600F	00-01
	CB600F2	00-01
RAD-123-RH	VTR1000F	03-06
RAD-123-LH	VTR1000RF	03-06

RMR-101

RADIATOR Mounting rubber and Collar set

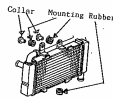

5 X MOUNTING RUBBER

5 X COLLAR

CB1000F	93-96	CBR600F	95-06	ST1100	92-02
CB1100SF	00-01	CBR600F2	02-04	ST1100A	92-02
CB1300	05-07	CBR600F3	95-98	ST1100P	93-00
CB1300A	05-07	CBR600F4	99-04	ST1300	02-06
CB1300F1	2003	CBR600FR	01-02	VF750C	93-02
CB1300F	2003	CBR600FS	01-02	VF750C2	97-00
CB1300S	05-07	CBR600RR	03-07	VFR750F	92-97
CB1300SA	05-07	CBR600SE	96-98	VFR800F1	98-01
CB500	94-02	CBR900RE	2001	VFR800	02-06
CB500S	98-02	CBR900RR	92-03	VFR800A	02-06
CB600F	98-07	CR125R	92-07	VT1100C2	97-05
CB600F2	00-03	CR250R	92-07	VT1100C3	98-02
CB600FA	2007	CR80R	92-07	VT1100C	97-99
CB900F	02-07	CR80RB	96-07	VTR1000F	00-07
CBF1000	06-07	CRF450R	02-04	VTR1000SP	00-06
CBF1000A	06-07	FJS600	01-02	VTX1800C1	05-07
CBF500	04-06	FJS600A	03-07	VTX1800C	02-04
CBF500A	04-06	FJS600D	03-07	XL1000V	99-07
CBF600N	04-06	NT650V	98-05	XL1000VA	04-07
CBF600NA	04-06	NT700	06-07	XL600V	92-99
CBF600S	04-06	NT700VA	06-07	XL650V	00-06
CBR1000F	92-99	NTV650	93-97	GL1500C	97-03
CBR1000RR	04-07	RVF750R	94-95	GL1500CD	01-03
				GL1500CT	97-00

EXHAUST SEALS

OEM QUALITY

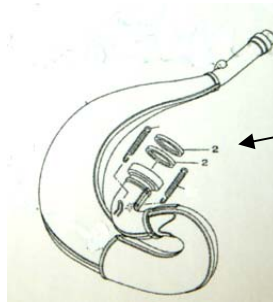

**TOUR
MAX**
HI-PERFORMANCE EQUIPMENT

YAMAHA		
EXS-201	YZ85	02-07
EXS-202	YZ125	01-07
EXS-203	YZ250	01-07
SUZUKI		
EXS-301	RM125T-Y	96-00
	RM125K1-K6	01-07
EXS-302	RM250	93-00
	RM250K1-K7	01-07
HONDA		
EXS-101	CR125R	01-07
EXS-102	CR250R	02-04
EXS-103	CR250R	93-01
	CR250R	05-07



SILENCER CONNECTING PIPE RUBBER for Honda Motocross bike

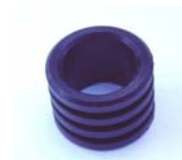

MC NO.	QTY.	MODEL YEAR	REF. O.E. NO.
MPG-101	2/SET	CR125 00-07	18365-KA4-730
MPG-102	2/SET	CR250 00-07	18365-KZ4-000

SPEEDOMETER CABLE & TACHOMETER CABLE

SPEEDOMETER



STOCK NO.	O.E.REF.	MODELS		
HONDA				
SPE-101	44830-300-672	CB750	K1-K2	71-76
SPE-102	44830-415-610	CX500		79
		CX500	A/B	80-81
		CX500D	A	80
SPE-103	44830-428-010 44830-428-000	XL250S		78-81
		XL500		
		XL500S		81-82
		XL500S		79-80
SPE-104	44830-392-672	CB750	K7	78
SPE-105	44830-323-000 44830-390-000 44830-415-000 44830-425-870 44830-463-000	CB350F		72-74
		CB400F/F2		74-77
		CB500		71-77
		CB500T		74-76
		CB550F1/F2		75-78
		CB550K		77-78
		CB750F	B/C/2C	81-82
		CB750F	A	80
		CB750F1		75-76
		CB750F2	F2	77-78
		CB750K		78-82
		CX500	Z	79
		GL1100	A/B/C	80-82
		GL1100D	A/B/C	80-82
GL1100I	A/B/C	80-82		
SPE-106	44830-098-000	ST50/70		
SPE-107	44830-166-000	MB50/80		
SPE-108	44830-389-770	MT50/80		
SPE-109	44830-GC5-000	MTX80C		82
SPE-110	44830-KB9-000	MTX80RSD/RFD		83
		XL125R	C	82
		XL200R		83-84
SPE-112	44830-MG2-000	XL600L	D	83
		XL600R		83-87
SPE-113	44830-MB1-000	VF750C		82-84
SPE-114	44830-431-670 44830-426-830	GL1000	K3/Z	
SPE-115	44830-356-010 44830-426-000 44830-447-000	CB1100R	B/C	82-83
		CB650C		80-81
		CB650Z		79-82
		CB900F	Z/A/B	79-80
		CB900F	2B	81
		CBX	B/C	80-81
		CBX	Z	79
		CM400A	A/B	80-81
		CM400A	Z	79
		CM400T	A/B	80-83
CM400T	Z	79		
SPE-116	44830-MB7-610	CB900F	C/2C	82
SPE-118	44830-460-840	CB650SC		82-83
SPE-119	44830-MA6-000	CBX550F	C	82
SPE-120	44830-MC8-000	FT500	C	82
SPE-121	44830-MA1-000	GL1500	B	81
		GL1500D	B	81
		GL1500I	B	81
SPE-123	44830-MA5-670 44830-449-610	CB750C		81-83
		CX500C	A	80
		CX500C	B	81
SPE-124	44830-449-840	CX500C	C	82
SPE-125	44830-MB2-000	VF750F	D/E	83-84
SPE-126	44830-413-000 44830-413-010	CB250N/NA		79-80
		CB250NDC		81
		CB250T1/T2		78
		CB400A		79
		CB400N/NA		79-85
		CB400NC		81
		CB400T1		
CB400TII		78		
SPE-127	44830-KJ9-000			
SPE-128	44830-428-830			

STOCK NO.	O.E.REF.	MODELS		
SPE-129	44830-KB4-700			
SPE-130	44830-KF0-000 44830-MG7-000	CM250C		82-83
		XR250R	G-K	86-89
SPE-131	44830-369-000			
SPE-132	44830-MC7-000	CBX750F		84-86
		CX500TC	C	82
SPE-133	44830-ME5-850 44830-MK3-000 44830-ME5-850 44830-MF5-000 44830-ME5-405	CX650C		83
		VT1100C		87-94
		VT500C		83-84
SPE-135	44830-MK4-000	CB750 NIGHTHAWK		91-96
		GB500		92-93
SPE-136	44830-MN9-000 44830-MR7-000 44830-MM9-000	NTV650	J-M	88-97
		NX650	J/K	88-91
		VFR750R	J	88-93
		XL600V		87-96
SPE-137	44830-MM5-000	XR750		88-90
		XR750		90-92
SPE-138	44830-KR5-010	VFR750F	L-P	90-94
SPE-139	44830-MF9-000	VT500E		83-85
		XL500R		82-85
SPE-140	44830-MR6-670	VT800C		88
SPE-141	44830-KS5-000	NX250		88-95
SPE-143	44830-MM4-000 44830-ML7-920	CB750F2 SEVEN FIFTY		92-99
		CBR1000F	J	88
SPE-144	44830-MN4-000	VFR750F	J/K	88-89
		CBR600F	M-R	91-94
		CBR600F		87-89
SPE-145	44830-MC5-000	CBR900RR	N-P	92-93
		CX650E	D	83
SPE-146	44830-MF2-000	VF500F	E/F	83-84
SPE-147	44830-MB9-780 44830-ME2-000	GL1100A	D	83
		GL1100D	D	83
		GL1100D2	D	83
		GL1100I	D	83
		GL650ID/DD/D2D		83
SPE-148	44830-MR1-000	VT600C	J-R	88-94
SPE-149	44830-MY2-620	NX500	N-R	92-94
		NX650	N-R	92-94
SPE-150	44830-MB4-000	VF1100C		83-86
SPE-151	44830-GAV-700			
SPE-152	44830-MG5-610 44830-MC9-770 44830-MJ1-000	CB1100F	D	83-84
SPE-153	44830-MN8-010			
SPE-154	44830-MJ4-670	VF1000R		85-86
SPE-155	44830-KY4-770			
SPE-156	44830-MR8-000	VFR400R		91
SPE-157	44830-MJ0-000	CB450N/S		85
		CB750M NIGHTHAWK		91
SPE-158	44830-MT3-000	ST1100		90-95
		VF750C		94-95
SPE-159	44830-MJ6-000	VFR750F		86-87
SPE-160	44830-GC8-000	CBR1000F	P/R/S	93-95
SPE-161	44830-ME9-000	VT750C	D/E/F	83-85
SPE-162	44830-MV4-000			
SPE-163	44830-KAF-000			
SPE-164	44830-ML0-720			
SPE-165	44830-KY1-010			
SPE-166	44830-KY2-700			
SPE-169	44830-KR3-000	CMX450C REBEL		86-87
SPE-170	44830-MS2-000			
SPE-171	44830-MV1-000	XR750	L	90
		XR750	P-S	93-95
SPE-172	44830-ML0-000			
SPE-187	44830-GW2-010	NH90		91-94
SPE-188	44830-MAY-620	XR750	T-Y	96-00
SPE-189	44830-KR5-900	VFR750F		90-93

STOCK NO.	O.E.REF.	MODELS		
SPE-191	44830-KA2-680	XR600R	P-R	93-94
		XR650R	Y/1	00-01
SPE-192	44830-MN5-000	GL1500	J	
		GL1500A	P-R	93-94
		GL1500SE	R-S	94-95
SPE-194	44830-KL3-000	XL350R		84-85
SPE-195	44830-KC1-000	CB125TD	C	82
	44830-KC1-010			
SPE-196	44830-383-000	CB125J		75-79
SPE-197	44830-MAW-760	XL650V	Y/1	00-01
SPE-A01	44830-MZ8-A20	VT600C		95-96
SPE-A02	44830-KK0-000	XR200R	P-T	93-96
SPE-A03	44830-MY5-860	CB500	T/V	95-97
SPE-A04	44830-MBZ-610	CB600F	W/X/Y	98-00
SPE-A05	44830-KK1-000	XR250R	E/F	84-85
SPE-A08	44830-MG9-000	GL1200A	E	84
		GL1200D	E	84-88
		GL1200I	E	84
SPE-A09	44830-MG3-010	XR250R	L-S	90-95
SPE-A10	44830-MB6-000	VF1000F	E/F/G	84-86
SPE-A11	44830-KB7-000	XL250R		82-88
		XL250S		82-83
	KAWASAKI			
SPE-401	54001-1002	Z650	B2-B3	78-79
		Z650C	C2-C3	78-79
		Z750	B2/B3	78-79
SPE-402	54001-1048	GPX1000RX		
		ZX1100	A1/A2	83-84
		ZX750	A1	84
SPE-403	54001-1014	GPZ1000		
		Z1000ST		79-80
		Z1100	B2	82
		Z750	E1	80
		Z750	L1	81
		Z750G2		
		ZX750	G1/G2	84-85
		ZX900	A1-A8	84-91
SPE-404	54001-1012	GPZ550		
		Z1000	A4	81
		Z400	J1/J2	80-81
		Z500	B1-B4	79-81
		Z550	D1	81
		Z550	H1	82
		Z650	F2-F3	81-82
		Z750	L2	82
		Z750 GP	R1	82
		ZR1100	A1-A2	92-93
SPE-405	54001-1029	KZ1100	A3	83
		VN750		86-95
		Z550	C1/C2	80-82
		Z750	H1-H2	80-81
		Z750	S1	82
SPE-406	54001-1024	Z440	A1-A3	80-82
	54001-1018	Z440	D	82-84
		ZR550	B2-B5	91-94
SPE-407	54001-1010	Z1000	A2-A3	79-80
		Z440	C1	
		Z900		76
SPE-408	54001-1118	ZX1100	C3	92
		ZX600	A1	85
SPE-409	54001-1116	KL600B		
SPE-410	54001-040	KZ900,Z1 900 A/B		73-76
		Z1000	A1	78
		Z1000	D1	78
SPE-411	54001-1147	ZX1000	B1	88
SPE-412	54001-1129	EX500	B1-B4	88-91
	54001-1155	EX500	A1-A7	87-93
		ZX400	L1/L2	91-92
SPE-413	54001-1123	ZX750	P1	96
		EL250	E1/E2	91-92
		EX250	F6/F7	92-93
		EX500	E9	02
SPE-414	54001-1113	EX500	D1-D3	94-96
		EN500	A1-A4	90-93

STOCK NO.	O.E.REF.	MODELS		
SPE-415	54001-1119	ZG1000	A1-A9	86-94
		ZX1000	A1	
SPE-416	54001-1143	ER500	A1-A3	97-99
		ER500	D1	01
		VN1500	C1/C2	94-95
		VN1500	A6	88
		ZR750	F1-F3	99-01
		ZR750	H1	01
		ZR750		
SPE-417	54001-1129	EX500	A1-A3	87-89
SPE-418	54001-1128	KL650	A1-A6	87-92
SPE-419	54001-1101	ZX600	D2/D3	91-92
SPE-421	54001-1193	KL650	A2-A4	92-94
		ZX1100<ZZR1100	D1-D4	93-96
		ZX600	F1/F2	95-96
SPE-422	54001-1209	KL650	C1/C2	95-96
SPE-423	54001-1112	KL250	D6-D11	89-94
SPE-424	54001-1152	KL650	B1-B3	89-91
SPE-425	54001-1145			
SPE-426	54001-1047			
SPE-427	54001-1195	ZX600	E1-E9	93-01
SPE-429	54001-1176	ZX750	L1-L3	93-95
SPE-434	54001-1236	VN1500	L1	
		VN1500	G1/G2	98-99
SPE-435	54001-1239	VN1500	J1/J2	99-00
SPE-436	54001-1144	VN1500	B6	92
		ZR1100	C1-C3	97-99
		ZR1100	D1-D4	97-00
		ZR1200	A1-A3	01-03
		ZR1200	B1-B3	01-03
		ZR1200	C1/C2	01-03
		ZR750	C1-C4	91-94
		ZX1100	E1	95
		ZX550	A1	84
		ZX750	E1-E2	84-85
	SUZUKI			
SPE-302	34910-45113 34910-45110 34910-45111 34910-45112	GS450	T	80
		GS450E	T	80
		GS450L	X	81
		GS450S		80
		GS850G	N	79
		GSX400E		80-81
SPE-304	34910-45411 34910-45410	GSX1100	T	80
		GSX1100E	T	80
		GSX750	T	80
		GSX750E	T	80
		GSX750E	T	80
SPE-305	34910-45231 34910-45230	GS1000L	N	79
		GS550	T	80
		GS550D	T	80
		GS550L	N	80
		GS750L	T	80
		GS850GL	T	80
SPE-306	34910-33400	GSX1100L	T	80
		GSX750E	E	84
		GSX750EF	F	84-86
SPE-307	34910-45123 34910-45120 34910-45121 34910-44900	GSX750ES	D/F	83-85
		GS1000	T	80
		GS1000E	T	80
		GS1000H	T	80
SPE-308	34910-16A01	GS405L		81-83
		GS450L		85-88
SPE-309	34910-48B00	GSX1100	K-N	89-92
SPE-310	34910-19C01 34910-40C01 34910-17C00 34910-17C01	GSX600F		88-97
		GSX750F	K-S	89-97
		GSX-R1100		89
		GSX-R750	J/K	88-89
		GSX-R750	L	90
SPE-311	34910-01D02 34910-01D00	GS500	K1/K2	01-02
		GS500E	K-N	89-92
		GS500E		95-00
SPE-312	34910-06B00	GS500E(U)	P/R	93-94
		GSX-R1100	G-J	86-88
SPE-313	34910-27A01	GSX-R750	G	86

STOCK NO.	O.E.REF.	MODELS		
SPE-314	34910-14A00	DR600	G-K	86-89
		DR600SF/UF/G/UG		85
SPE-315	34910-15500	GR650F		
SPE-316	34910-14D12 34910-14D10 34910-14D11	DR250	L-N	90-92
		DR250S	L-R	92-94
		DR250SE	S	95
		DR350		90-95
		DR350S	L-N	90-94
		DR350SE		94-97
SPE-317	34910-42A00	GSX1100F		
SPE-318	34910-17E00 34910-17E01	GSX-R1100W	P/R	93-94
		GSX-R600W	N	92
		GSX-R750W	N/P	92-93
SPE-319	34910-12E00	DR600	N	92
		DR650RE(R/UR)		94-95
SPE-320	34910-26D00	GSX1100G	M-R	91-94
SPE-321	34910-49010	GS1000E	C	78
SPE-322	34910-31E00	RF900	R/S	94-95
SPE-323	34910-45420/1	GSX750	X	81
		GSX750E	X	81
SPE-324	34910-38301 34910-38300	GN250	J	88
SPE-325	34910-24D10	DR125	G/H/J	86-88
SPE-326	34910-14A12 34910-14A11 34910-14D10 34910-29E20	DR650S	L/M	90-91
SPE-328	34910-09300 34910-49310			
SPE-329	34910-31990 34910-45222 34910-49400	GS1100G	E/F/G	
SPE-330	34910-38B00	VS1400GL(P/F)	H/J/K/L	87-94
SPE-331	34910-39A10/00	VS750		86-91
		VS800		92-99
SPE-332	34910-12D02			
SPE-333	34910-44B00			
SPE-334	34910-47D21	RF600R(U)		93-96
SPE-335	34910-04710			
SPE-336	34910-29C03			
SPE-337	34910-36A00	RG80CF		
SPE-338	34910-44A00	DR125SF		87
SPE-339	34910-11D01	GSF400	M/N/P	91-93
SPE-340	34910-31D00	DR800S		91-93
SPE-341	34910-41C00 34910-41C00	GSX-R1100		91-92
		GSX-R750	M/N	91-92
SPE-343	34910-22D00			
SPE-344	34910-44400 34910-16432 34910-47310 34910-33300 34910-47311 34910-16431	GS450S		82
		GS550	C/N	78-79
		GS550	B	77
		GS550	X	81
		GS550E	C/N	78-79
		GS550E	X	81
		GS550M	Z	82
		GS550T	X	81
		GS650GT	X/Z	
		GS750		77-79
		GS750D		77-79
		GS750E		78-79
		GSX400E		82-86
		GSX400FE		81
		GSX400S		82-86
SPE-345	34910-44031 34910-44030 34910-44035 34910-44032 34910-44033 34910 44034 34910-05310	GS400	C/N	78-79
		GS400	B	77
		GS400/E		77-83
		GS400E	C/N	78-79
		GS425	N	79
		GS425E	N	79
SPE-348	34910-12F00	GZ250	X/Y	99-00
SPE-349	34910-23E01 34910-23E00	GSF600/S		95-99
SPE-350	34910-32E00	DR650SE	T-Y	96-00

STOCK NO.	O.E.REF.	MODELS		
		YAMAHA		
SPE-201	1M1-83550-01			
SPE-202	341-83550-00	SR500		78-84
		XS500		
		XS650		77-83
SPE-203	351-83550-00	XS250/360/400		
SPE-204	481-83550-10	RD50M		80
SPE-205	3H6-83550-00	DT80MX		82
		XT125		82
		XT500		88
		DT125LC		82
SPE-206	10V-83550-00	DT80LC		83-84
		DT80LC2		85-97
SPE-207	34X-83550-00 34X-83550-01 34L-83550-01 34X-83550-02 34L-83550-00 2H7-83550-01 3Y0-83550-00 3Y0-83550-01	FJ1100		84-85
		FJ1200		88-97
		34X-83550-02	XS1100	80-83
		34L-83550-00	XS400DOHC	82-84
		2H7-83550-01	XS600Z	84
		3Y0-83550-00	XV125	97-00
		3Y0-83550-01	XV250S	97-00
			XV535	89-96
			XV535SE	88
			XZ550	82
SPE-208	4U5-83550-00	RD125LC		82
SPE-209	2L0-83550-00	RD80LCII		
		RD250/400		
		XS400		80-82
SPE-210	4L0-83550-00	XS400SE		82
		RD250LC		82
		RD350LC		82
		RD350YPVS		83-84
SPE-212	1J7-83550-00	XS750		
SPE-213	438-83550-00	XT500		
SPE-214	5Y1-83550-00	XT550		82-83
SPE-215	4G0-83550-00	FZ750		88
		TZR250		88
		XJ550		83
		XS750SE		80
		XJ600		84
SPE-216	33M-83550-00	XJ600		84
SPE-217	11L-83550-00	FZ750		88
		RD350		85
		TZR250		88
SPE-218	16M-83550-00	XJ900		83-84
		XS400SECA		82-83
SPE-219	3R8-83550-10	XJ650		83
		XJ900		85-86
SPE-221	2GH-83550-00	FZR1000		87-90
SPE-222	3AJ-83550-00	XT600Z		88-91
SPE-223	48Y-83550-00	XT350H.N		88
		XT600H/N		87
		XT600Z		86-87
		XTZ660		91-93
SPE-224	3YF-83550-00	DT125R		95-96
SPE-225	1LN-83550-01	DT125R		97-00
		DT125R		89
		XTZ750		
SPE-226	1JN-83550-01	SR500 DRUM BRAKE		88-90
SPE-228	2YK-83550-00	TDR250		88-89
SPE-229	3ET-83550-00 3ET-83550-01 3ET-83550-02	FZR600		91-93
		FZR600		91-93
SPE-230	55K-83550-01	XT600E		90
		XT600E		94-00
		XT600E H/N		91
		FZR750R		91
SPE-231	2HR-83550-00			
SPE-232	3LD-83550-00	XTZ750		90
SPE-233	3GM-83550-00	FZR1000		91-93
		XJ600S		92-95
SPE-234	3LP-83550-00	XV1100		94-99
		XV750		94-95
SPE-235	1RH-83550-00	FZR600		89-90
SPE-236	1FK-83550-10	TDM850		91-95
SPE-237	3TU-83550-00			
SPE-239	57A-83550-00	XV1100		89-92
		XV750		89-92

STOCK NO.	O.E.REF.	MODELS		
SPE-241	5K5-83550-00			
SPE-256	55K-83550-02	XV250		89-97
SPE-257	48Y-83550-02	XT350		87-92
SPE-259	4FM-83550-00	FZR1000		94-95
	4FL-83550-00	TZR125		95-97
	4FM-83550-02	YZF1000R		96-01
	4FM-83550-01	YZF750R		93-98
SPE-265	3XP-83550-01	TDM850		96-98
SPE-266	4FU-83550-01	TDR125		96-99
SPE-268	5R2-83550-00	RD80LCII		82
	46X-83550-01			
SPE-269	5A8-83550-00	XV1000		82
	2GH-83550-01			
SPE-270	5BF-83550-00	WR250F		01-02
		WR400F		99-02
		WR450F		03
SPE-272	3Y1-83550-00	XT250		82
SPE-274	5G0-83550-00	RD80MX		82

TACHOMETER

STOCK NO.	O.E.REF.	MODELS		
	HONDA			
THA-101	37260-149-000	CB550K3		77-78
THA-102	37260-443-610	CB250N		79-80
		CB250NDC		82
		CB400N/NA		79-80
		CB400NC		81-85
		CB250TA/T2		78
THA-103	37260-413-000	CB400TII		78
		CB400T2Z		
		CM400T	A/B	80-81
		CM400T	Z	79
		XL500R		82-87
THA-104	37260-428-830	XL500R		82-87
THA-105	37260-166-000	MB50/80		
THA-106	37260-300-000	CB250RS		80
		CB400F		74-77
		CB500K1		71-77
THA-107	37260-362-000	CB750	F2	78
		CB750F2		77-78
THA-108	37260-435-761			
THA-109	37260-449-840	CB750		69-76
THA-110	37260-390-000	CX500C		82-84
		CX650E	D	83
		CB550F1/F2		75-78
THA-111	37260-415-000	CB750	K7	77-78
THA-112	37260-415-010	CX500		79
		CX500	A	80
		CX500C	A	80
		CX500D	A	80
		CX500	B	81
THA-113	37260-MA5-670	CX500C	B	81
		CB750C		81-83
THA-114	37260-KB7-010	CB750F	2C	82
		CB750F	B/C	81-82
		XL600L	D	83
THA-115	37260-438-000	XL600R	D	83
		CB900F	2B/2C	81-82
THA-116	37260-425-000	CB900F	Z/A/B/2	79-81
		CB750F	Z/A	80
THA-117	37260-371-000	CB750K	Z/A	79-80
		GL1000K3/Z		79
THA-118	37260-422-000	CBX1000	Z/A/B/C	79-82
THA-119	37260-MC8-000	FT500	C	82
THA-120	37260-463-000	GL1100A/IA/DA		80
		GL1100B/IB/DB		81
		GL1100C/IC/DC/AC		82
		GL1100D/ID/DD/D2D/AD		83
THA-121	37260-MA6-000	CBX550F	C	82
THA-122	37260-399-000			
THA-123	37260-422-000			
THA-124	37260-MF9-000	VT500E	D	83
THA-125	37260-MB7-610	CB1100F	D	83
		CB900F	C/2C	82

STOCK NO.	O.E.REF.	MODELS				
THA-127	37260-MA1-730	GL1500C/IC/DC		83		
		GL500	D	82		
		GL500D	C	82		
		GL500I	C	82		
		GL650ID/DD/D2D		83		
THA-128	37260-426-000	CB650/B		79-82		
		CB650C		80-81		
THA-129	37260-460-840	CB650SC		82-83		
THA-130	37260-KB9-000	XL125R	C	82		
THA-131	37260-KC1-000	CB125TD	C	82		
		KAWASAKI				
THA-401	54018-1002	Z1000 ST		79-80		
		Z400B		78-79		
		Z400G				
		Z440	A1-A3	80-82		
		Z440	D	82-84		
		Z440	C1	80		
THA-402	54018-1008	GPZ550				
		Z400	J1/J2	80-81		
		Z500				
		Z500	B1-B4	79-82		
		Z550	C1/C2	80-82		
		Z550	D1	81		
		Z550 LTD		80-82		
		Z550B				
		Z650	F3	82		
		Z650	F3			
		Z750	E1	80		
		Z750	L1-L2	81-82		
		THA-403	54018-023 54018-1003	Z650	B2/B3	78-79
				Z650	C2/C3	78-79
				Z650	F2	81
Z650	F2					
Z650	D2			79		
Z750	H1-H2			80-81		
THA-404	54018-015	Z750 LTD				
		Z1000	A1-A4	78-81		
		Z1000	H1	80		
THA-405	54018-1004	Z1000 MK2		79-80		
		Z900.Z1 900 B/B		73-76		
		Z1000	D1	78		
THA-406	54018-1013					
THA-408	54018-024	Z250	C1	80		
THA-410	54018-1005	Z1300	A1-A3	79-81		
	SUZUKI					
THA-301	34940-45400 34940-44030 34940-44033 34940-44035	GS1000C/EC		78		
		GS1000T/HT/ET		80		
		GS425N/EN		79		
		GS450T/ET		80		
		GS850G	N	79		
		GS850G	T			
THA-302	34940-47030 34940-47032 34940-47031	GS550	B	77		
		GS550	C/N	78-79		
		GS550	T	80		
		GS550	C/N	78-79		
		GS550D	T	80		
		GS550E	C/N/T	78-80		
		GS550E	T	80		
		GS550E	X	81		
		GS550L	N	79		
		GS650GT	X/Z	81-82		
		GSX1100	X	81		
		GSX1100	X	81		
		GSX1100E	T/X	80-81		
		GSX1100L	T	80		
		GSX750	T	80		
		GSX750	X	81		
		GSX750E	T	80		
GSX750E	X	81				
GSX750L		80-81				

STOCK NO.	O.E.REF.	MODELS		
THA-303	34940-45212 34940-49400 34940-45030/1/2 34940-45033 34940-45210	GS1000L	N	79
		GS1100G	E/F/G	84-86
		GS750		77-79
		GS750D	C	77-79
		GS750L	N/T	79-80
		GS850GL	T	80
THA-304	34940-33300 34940-33211	GSX250	Z/D	82-83
		GSX250E	Z/D	82-83
		GSX250ES	Z/D	82-83
		GSX250S	Z	82
		GSX400FE	X	81
THA-305	34940-44111 34940-44110	DR250S	Z/D/E	82-84
		GS450L	X	81
		GSX1100	Z/D	82-83
		GSX1100E	Z/D	82-83
		GSX250	T/X	80-81
		GSX250E	T/X	80-81
THA-306	34940-01D02 34940-01D01	GS500	K1/K2	01-02
		GS500E	K/L/M/N	89-00
THA-307	34940-04720			
THA-308	34940-44311	GSX550E		85-87
	YAMAHA			
THA-201	2J2-83560-00	SR500		78-83
		SR500		84-89
		SR500		91-99
		XT250		82
THA-202	1E6-83560-52	XS500		
		XT500		88
THA-203	447-83560-00	XS650		77-83
THA-204	37A-83560-00	DT80LC		83-84
THA-205	53V-83560-00	DT80LC2		85-90
THA-206	4L0-83560-00	RD250LC		82
		RD350LC		82
THA-207	29L-83560-00	RD350YPVS		83-84
THA-208	30X-83560-00	XT350 H/N		88
THA-210	341-83560-01	XS400DOHC		
THA-211	5Y1-83560-00	XT550		82-83
THA-212	4G0-83560-00	XJ550		83
THA-213	34L-83560-00	XT600 H/N		87
		XT600Z		84
THA-214	1J7-83560-00	XS750		
THA-215	2G2-83560-00	XS750SE		80-82
THA-216	2L0-83560-00	XS400		82
		XS400		80
THA-217	3AJ-83560-00	XT600Z		88/90
THA-218	1VJ-83560-00	XT600Z		86
		XTZ660H/N		92-93
THA-219	4K0-83560-00	XJ550		81
		XJ650		80
THA-220	1GU-83560-02			
THA-221	5R2-83560-00	RD80LC		82
		RD80LC		82-83
THA-224	3YF-83560-00 3YF-83560-02	XTZ660		91-93
THA-225	4FU-83560-00	TDR125		96-99

STOCK NO.	O.E.REF.	MODELS
-----------	----------	--------

REMARKS: SPE-227 IS NO LONGER AVAILABLE
THA-209 IS NO LONGER AVAILABLE

REAR WHEEL DAMPER SETS

MC NO.	QTY.	MODEL	YEAR
RWD-101	5/SET	ST1100	94-02
		ST1100A (ABS)	92-02
		ST1100P	90-00
RWD-102	5/SET	GL1500A Aspencade	91-00
		GL1500L	1990
		GL1500SE	91-00
		GL1500CT	97-98
		GL1500C	97-98
		VT1100C2 Shadow	95-97
		NT650V	98-05
		NT700V	06-07
		NT700AV	06-07
RWD-103	4/SET	CBR1100XX Blackbird	97-98
		CBR1100XX Blackbird	99-06
RWD-104	5/SET	CB600F	98-99
		CB600F	02-04
		CB600F2	2002
		CB900F	02-06
		CBR600F	97-00
		CBR600F3	97-98
		CBR600F4	99-00
		CBR600SE	1998
		CBR900RR	98-99
RWD-105	5/SET	CB1000	94-95
		CB1100F	93-96
		CBR1000F Hurricane	87-99
		VF750C Magna	93-02
		VF750C2 Magna Deluxe	97-00
		VF750CDT Magna Deluxe	1996
		VF750CD Magna Deluxe	95-96
RWD-106	4/SET	CBR500	90-91
		CBR600F	87-90
		NV400C	95-97
		NV600C	93-94
		VT600C Shadow	88-97
		VT600CD Shadow Deluxe	93-98
RWD-107	5/SET	XRV750	90-00
RWD-108	6/SET	NX500	90-99
		NX600	90-99
		SLR650	97-98
		XL600V Transalp	90-99
		XL600V Transalp	00-06
		FX650	99-00
		FMX650	05-06
RWD-109	5/SET	VFR800FI	98-01
		VFR800	02-06
		VFR800A	02-06
RWD-110	5/SET	VTR1000F	97-00
		VTR1000F	01-06
		XL1000V	00-06
		XL1000VA	04-06

STEP RUBBERS

MAIN STEP

STOCK NO	MODELS	YEAR
STR-M01 2pcs/set	CBR1000F NSR125F NTV650	92-99 1992 1993
STR-M02 2pcs/set	VT1100C Shadow VT1100C1 Shadow VT1100D2 Shadow Ace VTX1800C VTX1800C1	94-99 95-99 1999 02-04 2005
STR-M03 2pcs/set	XL600V TRANSALP NX500 NX650 XRV750	92-99 02-04 92-04 92-00
STR-M04 2pcs/set	GL1800 Goldwing GL1800A Goldwing	06-07 01-05
STR-M05 2pcs/set	VT600C Shadow VT600CD Shadow VLX Del VT750DC VT750DCA VT750DCB VF750C Magna VF750C2 Magna Deluxe VF750CT VT125C	92-97 93-97 01-02 2003 2003 93-02 97-00 1996 99-06
STR-M06 2pcs/set	GL1500A Aspencade GL1500C Valkyrie GL1500CD Valkyrie GL1500CT Tourer GL1500SE	92-00 97-03 01-03 97-00 92-00
STR-M07 2pcs/set	NT650V NT700V NT700VA ST1100 ST1100A ST1100P ST1300 ST1300A XL1000V XL1000VA	98-05 06-07 06-07 92-02 92-02 93-00 02-06 02-06 99-07 04-07
STR-M08 6pcs/set	NV700C2 VT1100C2 Shadow VT600CD2 Shadow deluxe VT600CD Shadow Deluxe VT600C Shadow VT750C2 VT750C3 VT750CD3 VT750C Shadow	99-01 00-05 1999 1999 1999 98-01 00-01 00-01 98-00
STR-M09 2pcs/set	CB500 CB500S CB600F CB600F2 CB750F2	94-02 98-02 98-06 00-02 92-01

STR-M09	CB900F CB1000F CB1100SF CB1300 CB1300A CB1300F1 CB1300SA CBF500 CBF500A CBF600N CBF600NA CBF600S CBF600SA CBF1000 CBF1000A CBR600F CBR600F2 CBR600F3 CBR900RR CBR1100XX VFR800Fi VTR1000F XL1000V XL1000VA XL125V NT650 NSR125R	02-07 93-96 00-01 05-07 05-07 03-07 05-07 04-06 04-06 04-06 04-06 04-06 05-06 06-07 06-07 92-98 92-94 95-98 92-93 97-98 98-01 97-06 99-07 04-07 01-07 95-97 93-01
STR-M10	CA125S CMX-250C	95-99 96-93
STR-M11	VT750C VT750C2 VT750CA VTX1800C1	04-07 07 05-07 06-07
STR-M12	CB250 CB250P	92-00 04-06

PILLION STEP

STOCK NO	MODELS	YEAR
STR-P01 2pcs/set	GL1500 Valkyrie GL1500CD Valkyrie GL1500CT Tourer VT1100C2 Shadow VT1100C3 VT1100C Shadow VTX1800C	97-03 01-03 97-00 95-99 98-00 92-99 02-04
STR-P02 2pcs/set	C50S C50SW C90M C90 NSR50S ST50 ST90 CM125C VF750C Magna VF750C2 Magna Deluxe VF750CD VT125C VT125C2 VT600C Shadow	92-96 94-97 92-96 92-96 93-95 94-96 92-96 92-99 93-02 97-00 1996 99-06 2000 92-97

STR-P02	VT600CD Shadow Deluxe	93-97
	VT750C Shadow	04-07
	VT750C2	2007
	VT750DC	01-02
	VT750CA	06-07
	VTX1300S	03-07
	NV600C	93-94
	XL185S	92-93
STR-P03	VTX1800C1	05-07
STR-P04 RH&LH EACH 1PC	GL1800	01-05
	GL1800A	06-07
STR-P05	GL1500A	92-00
	GL1500SE	92-00
STR-P06	CA125S	95-99
	CMX250C	96-03

GROMMETS FOR HONDA

STOCK NR	POSITION	MODESL	
GRM-101	Air Cleaner	XL125S	79-85
		SL185S	79-83
		XR200	80-84
		XL100S	79-80
	Battery	NSR125R	93-01
		XR250L	91-96
		XR650L	99-08
		CM250C	82-83
		CBR1000F	90-99
	Electric	CX500A	78-79
		CX500D	79-81
		CX500C	80-82
	Fairing/Stay	CBX-A	81-82
	Frame	CBX-A	81-82
		XL200R	83-84
		XL250R	1984
		XL350R	84-85
		TRX125	85-86
	FR/RR Turn signal	XR650L	01-08
	Front Fender	XL100	77-78
XL100S		79-80	
XL125		76-78	
XL125S		79-85	
XL185S		79-83	
XL250S		78-81	
XL500S		79-81	
XR200		80-84	
TRX250		97-	
TRX250X		87-92	
TRX300EX		93-00	
TRX300EX		01-08	
TRX400FW		95-	
TRX700X		2008	
Fuel Tank	NSR125R	93-01	
	VTR250	89-90	
	VFR800Fi	98-01	
	VFR800	02-08	
	VFR800A	02-08	
Head Light	CB125S	80-82	
	XR200R	81-83	
	XR250	80-82	
	XR500	79-80	
	XR500R	81-82	
	ATV250SX	85-87	
Radiator	VT600C	88-99	
	VT600C	00-07	
	VT600CD	93-99	
	VT600CD	00-07	
	VT600CD2	99-00	
Reserver Tank	CX500	78-79	
	CX500C	79-82	
	CX500D	79-81	

STOCK NR	POSITION	MODESL	
GRM-101	Rear Light	NSS250	04-07
		NSS250A	04-07
		NSS250SA	04-05
		VFR800Fi	99-01
		VFR800A	02-08
		VFR800	07-08
	Seat/Seal Cowling	CB900F	02-07
		CBR1000F	87-92
		CBR1000F	93-99
	Wind Shield	CB750F2	98-01
	Rear Fender	CBF500	04-06
		CBF500A	04-06
		CBF600N	04-06
		CBF600NA	05-06
		CBF600S	05-06
		CBF600SA	05-06
		TRX300FW	92-95
		TRX300	92-95
		TRX400FW	1995
		TRX450ER	06-07
	TRX450ER	06-07	
Tail Light	CBR600FR	01-02	
	CBR600FS	01-02	
	CBR600F4	01-03	
	CBR1100XX	97-04	
	VTR1000SP	01-06	
Number Plate Bracket	CBR600F2	92-94	
	CBR600F3	95-98	
	CBR600F4	99-03	
	CBR600FR	01-02	
	CBR600FS	01-02	
	CBR600SE	96-98	
	CBR900RE	2001	
	CBR900RR	92-00	
	VTR1000F	98-03	
	VTR1000SP	01-06	
XR125L	03-06		
Shelter	ST1100	92-02	
	ST1100A	92-02	
	ST1100P	93-96	
License Light Stay	VT750C	97-01	
	VT750CD3	00-01	
	VT750C2	97-00	
	VT750C3	00-01	
	VT1100C2	00-05	
GRM-102	Air Cleaner	TRX350FE	00-06
		TRX350FM	00-04
		TRX350TE	00-06
		TRX350TM	00-06
	Cowl	GL1800	06-08
		GL1800A	01-05
Upper Cowl	CBR600F	01-06	
	CBR600F4	01-04	

STOCK NR	POSITION	MODESL	
GRM-102	Radiator	CBR600FR	01-02
		CBR600F2	91-94
		CBR600F3	95-96
		CBR600SJR	1996
Frame	TRX650FA	03-05	
	TRX650FAG	04-05	
	TRX680FA	06-08	
	TRX680FAG	06-08	
Oil Cooler	VFR700F	1986	
	VFR700F2	86-87	
	VFR750F	90-97	
	CB750F2	92-03	
	RVF750R	94-95	
	RVT1000R	00-05	
	CB1100SF	00-01	
	CBR600F	87-90	
	CBR1000F	87-99	
	CBR1100XX	97-00	
	CBR1100XX	01-06	
	VFR800Fi	98-01	
	VFR800	02-08	
	VFR800A	02-08	
	VTR1000F	97-05	
	VTR1000SP	00-06	
	CBF500	04-06	
	CBR500F	04-06	
	CBF600N	04-06	
	CBF600S	04-06	
	CBF600NA	04-06	
	CBF600SA	04-06	
	TRX250EX	01-08	
	TRX250TE	02-08	
	TRX250TM	02-08	
	TRX350FE	01-06	
	Oil Cooler	TRX350FM	00-04
TRX350TE		00-06	
TRX350TM		00-06	
TRX400EX		99-08	
TRX400FA		04-07	
TRX400FGA		04-07	
TRX400FW		95-03	
TRX450ES		98-01	
TRX450FE		02-04	
TRX450FM		02-04	
TRX450R		04-07	
TRX450S		98-01	
TRX500FE		05-08	
TRX500FM		05-08	
TRX500TM		05-06	
TRX500FPE		07-08	
TRX500FPM	2008		
Front Fender	TRX450R	04-05	
Fuel Pump	TRX350FE	2006	
	TRX350FM	2006	
	TRX350TE	2006	
	TRX350TM	2006	
	TRX420FE	07-08	
	TRX420FM	07-08	
	TRX420TE	07-08	
	TRX420TM	07-08	
	TRX680FA	06-08	
	TRX680FGA	06-08	

STOCK NR	POSITION	MODESL		
GRM-102	Radiator	CB400F	89-90	
		CB500S	98-02	
		CB600F	98-07	
		CB600F2	00-02	
		CB600FA	2007	
		CB900F	02-07	
		CB1000A	94-95	
		CB1000F	93-96	
		CB1100SF	00-01	
		CB1300	05-07	
		CB1300A	05-07	
		CB1300F1	2003	
		CB1300F	2003	
		CB1300S	05-07	
		CB1300SA	05-07	
		CBF1000	06-07	
		CBF1000A	06-07	
		CBR600F	92-06	
		CBR600F4	99-04	
		CBR600FR	01-02	
		CBR600RS	01-02	
		CBR600RR	03-07	
		CBR600SE	96-98	
		CBR900RE	2001	
		CBR900RR	92-03	
		CBR1000F	90-99	
		CBR1000RR	04-07	
		CBR1100XX	97-06	
		Radiator	VF750C	93-02
			VT250C	99-06
			VT250C2	00-01
			VT1100C	97-98
			VT1100C2	97-05
			VT1100C3	98-00
		VTR1000F	97-06	
		VTR1000SP	00-06	
		VTX1300S	03-07	
	VTX1800C1	02-04		
	VTX1800C	05-07		
	XL125V	01-07		
	XL600V	92-99		
	XL650V	01-06		
	XL1000V	01-07		
XL1000VA	04-07			
XR650R	01-07			
XR750	93-00			
CR80R	92-02			
CR80RB	96-02			
CR85R	03-07			
CR85RB	03-07			
CR150R	2007			
CR150RB	2007			
CR450R	02-04			
FJS600	01-02			
FJS600A	03-07			
FJS600D	03-07			
GL1500C	97-03			
GL1500CD	01-03			
GL1500CT	93-00			
NT650V	98-05			
NTV650	93-97			
RVF750R	94-95			

STOCK NR	POSITION	MODESL		
GRM-102		ST1100	92-02	
		ST1100A	92-02	
		ST1300	02-06	
		ST1300A	02-06	
		TRX450ER	06-07	
Fuel Tank	Tail Light	CBR1000F	90-99	
		NT650V	98-05	
GRM-103	Expans. Chamber	CR125R	92-07	
		CR250R	92-07	
		CR80R	96-02	
		CR80RB	96-02	
		CR85R	03-07	
		CR85RB	03-07	
	Muffler	CR125R	90-99	
		CR250R	85-99	
		CR500R	90-01	
		CR80R	96-99	
		CR80RB	96-99	
		Fuel Pump	TRX420FE	07-08
	TRX420FM		07-08	
	TRX420TE		07-08	
	TRX420TM		07-08	
	TRX680FA		06-08	
	TRX680FGA		06-08	
	TRX700XX		2008	
	CR500R		90-01	
	Fuel Tank	TRX90	93-06	
		TRX90EX	07-08	
		TRX250EX	01-08	
		TRX350FE	00-06	
		TRX350FM	00-06	
		TRX350TE	00-06	
		TRX350TM	00-06	
		TRX400EX	99-08	
		TRX400FA	04-07	
		TRX400FGA	04-07	
		TRX400FW	95-03	
		TRX450ES	98-01	
		TRX450FE	02-04	
		TRX450FM	02-04	
		TRX450S	98-01	
		TRX500FA	05-08	
TRX500FE		05-08		
TRX500FM		05-08		
TRX500FGA		05-08		
TRX500FPE	07-08			
TRX500TM	05-07			
TRX700XX	2008			
GRM-104	Air Cleaner	ATC125M	86-87	
		ATC200X	83-85	
		ATC250ES	86-87	
		ATC250R	83-84	
		ATC350X	85-86	
		TRX125	87-88	
		TRX200SX	86-88	
		CR250R	78-80	
		Battery	VT750C	98-00
			VT750C	04-08
			VT750C2	07-08
			VT750C2F	07-08
			VT750C3	2001

STOCK NR	POSITION	MODESL	
GRM-104		VT750CA	04-08
		VT750CD	98-01
		VT750CD2	98-01
		VT750CDA	02-03
		VT750CDB	02-03
		VT750CDC	02-03
		VT750CDD	02-03
		VT750DC	01-02
		VT750DCA	03-07
		VT750DCB	03-07
	Front fender	ATC200X	83-87
		ATC250R	81-86
		ATC350X	85-86
		CR125R	79-80
		CR250R	78-80
	Radiator	CR125R	98-99
		CR250R	78-80
		CR250R	97-99
		VTX1800C	05-07
	Rear Fender	ATC250ES	85-87
CR125R		1979	
CR250R		78-80	
	FX650	97-98	
Cowl	CBF1000	06-07	
	CBF1000A	06-07	
	CBF600S	04-06	
	CBF600A	04-06	
	XL650V	00-06	
	XL1000V	99-02	
Head Light	XR750	93-00	
	Handle Pipe Top Bridge	CB1100SF	00-01
GRM-105	Fuel Tank	VT1100C	97-07
		VT1100C2	95-07
		VT1100C3	98-02
		VT1100D2	1999
		VT1100T	98-01
		GL1500C	97-03
		GL1500CD	01-03
	GL1500CF	99-01	
	GL1500CT	97-00	
	Cowl	XL600V	89-99
Head Light	NX650	88-99	
Radiator	ST1100	91-02	
	ST1100A	92-02	
	ST1100P	93-96	
GRM-106	Expans.	CR80R	85-89
	Muffler	CR80R	90-95
	Fuel Tank	CBR1000F	87-88
		Radiator	VT750C
		VT750C2	98-02
	Radiator	VT750C3	2000
		VT750CD3	00-01
		VT750C2F	07-08
VT750CA		04-08	
VT750CD		98-01	
VT750CD2		98-01	
VT750CDA		02-03	
VT750CDB	02-03		
VT750CDC	02-03		
VT750CDD	02-03		
VT750DC	01-02		
VT750DCA	03-07		

STOCK NR	POSITION	MODESL		
GRM-106	Radiator Guard	VT750CDB	03-07	
		CBR1000RR	06-07	
		CR125R	1983	
		CR250R	1983	
		CR80R	83-84	
GRM-107	Carrier	VT1100C2	98-99	
		VT1100C3	98-02	
TRX400FW		95-03		
TRX450ES		98-01		
TRX450FE		02-04		
GRM-107	Frame Rear Fender	TRX450FM	02-04	
		TRX450S	98-01	
		TRX250X	91-92	
		VT125C	00-06	
		VT125C2	00-01	
	Seat Seat/Rear Cowl	VF750C	94-03	
		VF750C2	97-00	
		VF750CD	95-96	
		VF750F	90-93	
		VFR750F	92-93	
GRM-108	Radiator	ATC250R	85-86	
		CBR600F	87-90	
		CBR1000F	87-96	
		FL400R	89-90	
		VFR700F	1986	
		VFR700F2	86-87	
		VFR750F	1986	
GRM-109	Radiator	CRF250R	04-08	
		CRF250X	04-08	
		CRF450R	05-08	
		CRF450X	05-08	
GRM-110	Fuel Pump	ST1300	02-08	
		ST1300A	02-08	
		ST1300P	05-06	
	Rear Fender	XL100	77-78	
		XL125	77-78	
		CBF1000	06-07	
		CBF1000A	06-07	
	Seat	VT1100C	97-07	
		VT1100C3	98-02	
		VTX1300R	05-08	
		VTX1300S	03-07	
		VT750C	05-07	
	Wind Shield	VT750CA	06-07	
VT1100T		98-01		
VT1100T1		2007		
VT1100T2		2007		
GRM-111		Air Cleaner	GL1200	1984
			GL1200A	84-87
	GL1200I		84-87	
	GL1200L		1985	
	GL1200SE		1986	
GRM-111	Cowl Stay Head Light	ST1100A	99-02	
		TRX450R	04-05	
		TRX400EX	05-07	
GRM-111	Crankcase Cover LH	VT1100C	97-07	
		VT1100C2	95-07	
		VT1100C3	98-02	
		VT1100D2	1999	
	Meter	VT1100T	98-01	
		NX250	88-90	
		NX650	92-99	

STOCK NR	POSITION	MODESL		
GRM-111		FX650	99-00	
		Rear Cowl Speed & Tach Meter	CBR1100XX	1997
			NX650	88-89
		Cowl Stay Cowl	ST1100A	96-02
			XL650V	00-06
			XL1000V	99-02
		Side Cover Winker/Reflector	XL650V	02-06
			XRV750	93-95
		Water Pump	VT750C	98-01
			VT750C2	97-01
			VT750C3	00-01
	VT750CD	98-01		
	VT750CD2	98-01		
	VT750CD3	00-01		
	VT750CDA	02-03		
	VT750CDB	02-03		
	VT750CDC	02-03		
	VT750CDD	02-03		
	VT750DC	01-02		
	VT750DCA	03-07		
	VT750DCB	03-07		
GRM-112	Shelter	GL1200	84-85	
		GL1200A	84-87	
		GL1200I	84-87	
		GL1200SEi	1986	
	Air Cleaner	XL600V	89-99	
		GL1500	88-90	
		GL1500A	91-00	
		GL1500I	91-96	
		GL1500SE	90-00	
	Cowl	NX650	88-89	
NX650		92-99		
GRM-112	Fuel Tank	TRX350D	87-89	
		TRX350	86-87	
		TRX450ER	2008	
		VF500C	84-85	
		VF700C	1984	
		VF700S	84-85	
		VF750S	1983	
		VF750S	1983	
		VF750C	82-83	
		VF1100S	84-85	
VF1100C	83-86			
GRM-112	Muffler Under Cowl	FX650	99-00	
		XL125V	01-06	
		XL600V	92-99	
		XL650V	01-06	
		XL1000VA	04-07	
	XL1000V	99-07		
GRM-113	FUEL TANK	ATC185S	1981	
	Frame Fuel Tank	TRX700XX	2008	
		ATC200X	83-87	
		TRX125	87-88	
	Fuel Tank	XL80S	80-85	
		XL100S	81-85	
	Fuel Tank	CB1100SF	00-01	
		CBR1100XX	97-06	
	Rear Fender	TRX250X	87-92	
TRX250R		86-89		
Seat	TRX250EX	01-08		
	TRX300EX	93-00		
	TRX300EX	01-08		

STOCK NR	POSITION	MODESL	
GRM-113	Seat/Rear	ATC350X	85-86
GRM-114	Frame	ATC200E	82-83
		ATC200ES	1984
		ATC200M	1985
		ATC250ES	85-87
		ATC250SX	85-87
		TRX200	84-87
	Head Light	CBR1000RR	04-07
		VFR800	02-08
		VFR800A	02-08
	Rear Fender	VT750DC	01-02
		VT750DCA	03-07
		VT750DCB	03-07
	Sub-Harness	CBR600RR	07-08
	Tail Light	VT750C	04-08
VT750C2		07-08	
VT750C2F		07-08	
VT750CA		04-08	
Under Cowl	CBR600RR	03-06	
	CBR1000RR	2008	
	CB1300S	05-07	
	CB1300SA	05-07	
GRM-115	Fuel Tank	XR650L	94-00
		XR650L	01-08
	Rear Brake Master Cylinder	TRX250X	91-92
		TRX300EX	93-00
	Rear Fender	TRX300EX	01-08
		TRX300FE	04-06
		TRX300FM	04-06
		TRX300TE	04-06
		TRX300TM	04-06
		TRX350FE	04-06
		TRX350FM	04-06
		TRX350TE	04-06
		TRX350TM	04-06
		Rear Fender	TRX400FA
	TRX400FGA		04-07
	TRX500FE		05-08
	TRX500FM		05-08
TRX500TM	05-06		
TRX500FPE	07-08		
TRX500FPM	2008		
TRX650FA	03-05		
TRX650FGA	04-05		
TRX680FA	06-08		
TRX680FGA	06-08		
GRM-116	Cooling Fan	GL1500	88-90
		GL1500A	91-00
		GL1500I	91-96
		GL1500SE	90-00
	Radiator	NX250	88-90
		TRX250R	86-89
		GL1500	88-90
		GL1500A	91-00
		GL1500I	91-96
		GL1500SE	90-00
GRM-117	Air Cleaner	TRX350	86-87
		TRX350D	88-89
	Rear Fender	CB400F	89-90
CBR600F		87-90	
Tail Light	CB1000	94-95	

STOCK NR	POSITION	MODESL	
GRM-117		VFR750F	90-97
GRM-118	Fuel Tank	CR125R	98-07
		CR250R	97-07
		CRF250R	04-08
		CRF250X	04-07
		CRF450X	2008
GRM-119	Frame/Oil	CB700SE	84-86
	Fuel Sub-Tank Fuel Tank	VT1100C	85-86
		VT700C	86-87
		VT800C	1988
	Radiator	CBR1000F	87-88
		GL1500	88-92
		GL1500A	91-00
		GL1500I	91-96
	GL1500SE	90-00	
	Wind Sheild	VT750C	05-07
VT750CA		06-07	
VTX1300S		03-07	
Pannier Stay	XL1000V	03-06	
	XL1000VA	03-06	
GRM-120	Shelter	GL1200A	84-87
		GL1200I	84-87
		GL1200L	1985
Rear Wheel	ATC185	80-82	
	ATC185S	81-83	
Tail Light	ATC200	81-83	
	VT750DC	01-02	
	VT750CA	2003	
	VT750CB	2003	
Front Final Gear Air Cleaner	TRX300FW	92-00	
	CB350F		
	CB350F1		
	CB400F	76-77	
	CL100K1/K2		
	CL100S/S2/S3		
	SL100/K1/K2/K3		
	XL80S	80-85	
	XL100/K1		
	XL100S	81-85	
	TL125S	1976	
	CM185T	78-79	
	CM200T	80-82	
CBF250	04-06		
Air Cleaner/Battery	CB125S	76-82	
	CT125	77-78	
	XL125	76-78	
Air Cleaner/Side C	XL175	76-78	
	XL250	1976	
	XL350	76-78	
	XR75	77-79	
	XR80	80-82	
	XR100	81-84	
Air Cleaner/Tool B	CB125S/S1/S2		
	CL125S/S2 SL125/K1/K2		
Battery	CBX-A	79-82	
Battery/Left	VF1000R	85-86	
Head Light	XR250R	96-02	
	XR400R	96-02	
	XR650R	00-07	
Head Light	CB125S	76-78	

STOCK NR	POSITION	MODESL	
GRM-120		CM185T	78-79
		CM200T	80-82
		CB650	1979
		CB750F	1976
		CB750F	79-81
		CB900F	81-82
		VF1000F	1984
		VF1000R	1985
		CBX-A	79-80
		GL500	81-82
		GL650	1983
		CB750K	79-82
	Head Light/Bracket	XL125	76-78
		XL125K	
		XL100	77-78
	Seat	CB750K	79-82
		CB750L	1979
	Cowl	NX250	88-90
		VF700F	83-85
	Frame	ATC250ES	85-87
	TRX200	90-91	
	TRX200D	91-97	
	TRX250X	87-92	
Fuel Tank	CBR900RR	96-99	
	VF1100C	83-86	
	VF500C	84-85	
	VF750C	82-83	
	VF700C	1984	
	VT700C	84-85	
Front Final Gear	TRX300FW	88-91	
Radiator	XL600V	89-99	
	XRV750	92-00	
Rear Seat	CA125	95-99	
	CMX250C	96-03	
Upper Cowl	CBR900RE	2001	
	CBR900RR	00-01	
Chain Case	VT600C	88-92	
	VT600C	00-07	
	VT600CD	93-07	
Rear Fender	VT750DC	01-02	
	VT750CA	2003	
	VT750CB	2003	
GRM-121	Muffler (Exhaust)	ANF125	03-07
		ANF125T	05-06
		CB600F	04-06
		CBR600RR	03-08
		CBR1000RR	04-07
		VFR800	2008
		VFR800A	2008
		XL125V	01-07
		XL1000V	99-07
		XL1000VA	04-07
	Step Assy	VFR800	02-07
		VFR800A	02-07
	GRM-122	Muffler (Exhaust)	NT700V
NT700VA			06-07
VFR800			02-06
VFR800A			02-06
ST1300			04-08
ST1300A			04-08
	ST1300P	05-06	

STOCK NR	POSITION	MODESL			
GRM-122	Radiator	VTX1800N1	04-08		
		VTX1800N2	04-05		
		VTX1800N3	04-05		
		VTX1800R1	04-05		
		VTX1800R2	04-05		
		VTX1800R3	04-05		
		VTX1800S1	04-05		
		VTX1800S2	04-05		
		VTX1800S3	04-05		
		VTX1800C2	05-06		
		VTX1800C3	05-06		
		GRM-123	Muffler	VTX1300C	04-08
				VTX1300R	04-08
VTX1300S	03-07				
VTX1800N1	04-05				
VTX1800N2	04-05				
VTX1800N3	04-05				
VTX1800R	02-04				
VTX1800C	02-03				
VTX1800C1	05-07				
VTX1800C2	05-06				
VTX1800C3	05-06				
VTX1800F1	05-08				
VTX1800F2	05-07				
VTX1800F3	05-08				
CB400F	89-90				
CB600F	98-00				
CB600F2	00-01				
CB900F	02-07				
CBR600F	92-03				
Muffler	CBR600F2		91-94		
	CBR600F3	95-98			
	CBR600F4	99-06			
	CBR600SE	1998			
	CBR600FR	01-02			
	CBR600FS	01-02			
	CBR600RR	03-04			
GRM-124	Muffler	CB550SC	1983		
		GB500	89-90		
		CBR600F	87-90		
		CBR600F4	01-03		
		CBR600FR	01-02		
		CBR600FS	01-02		
		CBR900RE	2001		
		CBR900RR	92-03		
		CBR1000F	87-99		
		CBR1100XX	97-06		
		ST1100	91-02		
		ST1100A	92-02		
		VTR1000F	97-05		
XL1000V	00-02				
CB1100SF	00-01				
CB1300	05-07				
CB1300A	05-07				
CB1300S	05-07				
CB1300SA	05-07				
GRM-125	Muffler	GL1500	88-90		
		GL1500A	91-99		
		GL1500I	91-96		
		GL1500SE	91-99		
		GL1800	01-07		
		GL1800A	01-05		
		NRX1800DA	04-05		
		NRX1800DB	04-05		

STOCK NR	POSITION	MODESL	
GRM-125	Rear Fender B Set	NRX1800EA	04-05
		NRX1800EB	04-05
		GL1500	1990
		GL1500SE	90-92
		GL1500A	1992
		GL1500I	1992
GRM-126	Speed/Tachometer Case	GL1200A	86-87
		GL1200SE	1986
	Cooling Fan	GL1800	01-07
		GL1800A	01-05
	Cowl/Front Cover	CB500S	98-02
		CB600F2	00-02
		FJS600	01-02
	Cowl/Front Cover	FJS600A	03-07
		FJS600D	03-07
		VFR1000F	98-06
	Upper Cowl	CBR600F	87-00
		CBR600F2	91-94
		CBR600F3	95-97
		CBR600F4	99-00
		CBR600SE	1998
		CBR900RR	95-99
		GL1500CF	99-01
	Fairing	ST1100	91-02
		ST1100A	92-02
		ST1100P	93-96
		VTX1800N1	06-08
		VTX1800N2	04-05
		VTX1800N3	04-05
		VTX1800R1	04-05
		VTX1800R2	04-05
		VTX1800S1	04-05
		VTX1800S2	04-05
VTX1800S3		04-05	
VTX1800C1		05-07	
VTX1800C2		05-06	
VTX1800C3		05-06	
VTX1800F1		05-08	
VTX1800F2	05-06		
VTX1800F3	05-08		
Meter Stay	GL1200I	84-87	
	GL1200A	1985	
	GL1200L	1985	
Head Light	RVF750R	94-95	
	VFR700F	1986	
	VFR700F2	1987	
	VFR750F	1986	
Radiator	CBR900RR	92-94	
	NES125	00-06	
	NES150	00-06	
	SES125	02-04	
	SES150	02-04	
	CR125R	1981	
	CR250R	1981	
	VF500F	84-86	
	VF700F	84-85	
	VF700S	84-85	
	VF750C	82-83	
	VF750F	83-84	
VF750S	82-83		

STOCK NR	POSITION	MODESL	
GRM-126		VF1000F	84-86
		VF1100C	83-86
		VF1100S	84-85
		VT1100C	92-96
		VT1100C2	95-96
	GL1200	1984	
	Radiator	GL1200A	84-87
		GL1200I	84-87
		GL1200L	1985
		GL1200SE	1986
VT1100C2		95-99	
Tail Light	VT1100D2	1999	
	VT1100T	98-01	
GRM-127	Head Light	CMX450C	86-87
	Meter Stay	GL1500C	97-03
GL1500CD		01-03	
GL1500CT		97-00	
VT1100C2		00-07	
VT750C		98-99	
VT750CD		98-99	
VT750CD2		98-99	
VT600C	92-07		
VT600CD	93-07		
VT600CD2	99-00		
GRM-128	Battery	ST1100	91-02
		ST1100A	94-02

O.E.REF

GRM-101	61103-357-000
GRM-102	19051-KA3-830
GRM-103	18334-KA3-830
GRM-104	61103-430-000
GRM-105	19051-GE2-000
GRM-106	19051-KA3-710
GRM-107	50370-HA2-770
GRM-108	19052-HA2-000
GRM-109	19051-KRN-000
GRM-110	80106-382-770
GRM-111	80105-MG9-000
GRM-112	17611-MB1-000
GRM-113	17611-HA5-000
GRM-114	90852-898-000
GRM-115	33718-GE2-690
GRM-116	19012-HB9-000
GRM-117	17237-HA7-670
GRM-118	18334-ML3-680
GRM-119	15604-MG7-000
GRM-120	17245-107-010
GRM-121	18345-MBT-610
GRM-122	18316-KFT-620
GRM-123	18421-KAF-000
GRM-124	18421-MA6-000
GRM-125	18421-MN5-000
GRM-126	19051-KA4-000
GRM-127	33718-MM2-000
GRM-128	19051-MB4-880

CONTROL CABLES

CLUTCH CABLES

STOCK NO	MODELS
	HONDA
CLU-109	CB250N/400N
CLU-125	CB250RJ/RK MC19
CLU-103	CB400T1
CLU-104	CB400T2'78 CB250T1/T2
CLU-108	CB750FB/FC/F2C'81-82CB750FA'80
CLU-120	CB750FZ'79
CLU-101	CB750K1-K2
CLU-102	CB750K7'78
CLU-137	CB750F2 SEVEN FIFTY'92-99
CLU-119	CB900F2B/F2C'81-82
CLU-107	CB900FZ'79 CB900FA/FB'80-81
CLU-116	CBR600F'87-89
CLU-138	CBR600F'91-96
CLU-139	CBR600F'97-98
CLU-140	CBR900RR'92-93
CLU-118	CBR900RR(R-S)'94-95
CLU-141	CBR900RR'98-99
CLU-110	CM400T(A/B)'80-81 CM400T(Z)
CLU-106	CX500'79
CLU-105	CX500A/B'80-81, CX500D(A) CX500Z
CLU-111	CX500CB'81 CX500CA'80
CLU-115	CX500ED'83
CLU-112	GL500D(C)'82 GL500I(B-C)
CLU-114	VT500ED'83
CLU-117	VT600C(J)'88
CLU-142	VT600'93-97
CLU-143	VT1100C2'95-99
CLU-144	XL600V'87-93
CLU-145	XRV750'93-00
CLU-191	CBR600F1-F5'01-05 CBR600F4Y-F44'00-04 CBR600FR1/FR2'01-02
CLU-192	CBR600FK/FL'89-90
CLU-193	CBR600RR3/RR4/RR5'03-05
CLU-194	CBR900RRT/RRV'96-97
CLU-195	CBR900RRY/RR1'00-01 CBR900RE1'01
CLU-196	CBR900RR2/RR3'02-03
CLU-197	CB600FW-F1 HORNET'98-01 CB600F2Y/F21 HORNET'00-01
CLU-198	CB900F2-F5 HORNET'02-05
CLU-186	NTV600M'91 NTV650M'91 NTV650P'93 NTV650S/T/V'95-97
CLU-187	NX500J/K/L/M DOMINATOR'88-91 NX650J/K/L/M DONIMATOR'88-91
CLU-1A02	NX500P/R/S/T DOMINATOR'93-96 NX650P/R/S/T DOMINATOR'93-96
CLU-1A03	VF750CS/CT/CV/CW'95-98 VF750CX/CY/C1/C2'99-02 VF750C2V/C2W/C2X/C2Y'97-00 VF750CDT'96
CLU-1A04	VT1100C2Y-C25 SHADOW'00-05
CLU-1A05	VT1100C3W-C32 SHADOW'98-02
CLU-1A06	XL600VR-VW TRANSALP'94-98
CLU-1A07	XL600V1-V4 TRANSALP'01-04
CLU-1A08	XL1000VX-V2 VARADERO'99-02

STOCK NO	MODELS
	YAMAHA
CLU-267	YZ250'94-98 WR250'95-98
CLU-269	YZ400'98-99 WR400F'98-99
CLU-268	YZ250F'03-05 YZ450F'04-05
CLU-204	RD350LC'82 RD250LC'82
CLU-227	RD350LC'91-92
CLU-201	SR500'78-83
CLU-203	SR500'84-99
CLU-229	SRX600'86-87
CLU-221	TDM850'91-93
CLU-222	TDM850'94-95
CLU-207	XJ600S'92-95
CLU-223	XJ900S'95-01 DIVERSION
CLU-225	XT500'76-89
CLU-212	XT550'82-83 XT600E'87-90
CLU-202	XT600Z'84
CLU-214	XT600Z TENERE'86-90
CLU-224	XT600E'90-95
CLU-236	XTZ750 SUPER TENERE'89-95
CLU-206	XV535'88-94 VIRAGO XT660'84-90
CLU-252	XV535 VIRAGO (UP HANDLE)'95-01
CLU-253	FZS600 FAZER'98-01
CLU-254	FZS600 FAZER'02-03
CLU-255	YZF-R6'99-02
CLU-256	XVS650 DRAG STAR'97-00
CLU-262	XVS650 DRAG STAR'01-02
CLU-263	XVS650A DRAG STAR CLASSIC'98-02 XVS650A DRAG STAR CLASSIC'04-05
CLU-257	TDM850'96-01
CLU-258	TDM900'02-05
CLU-270	TRX850'96-97
CLU-259	FZS1000 FAZER'01-04
CLU-260	YZF-R1'98-01
CLU-261	YZF-R1'02-03
CLU-215	XV1100 VIRAGO'89-97 XV750'92-96
CLU-271	XVS1100'02-06
CLU-272	XV1600'99-02
	SUZUKI
CLU-362	RM125'97-96
CLU-363	RM125'98-00
CLU-318	DR600S F-K'85-89 DR600R G-K'86-89 DR600R L-M'90-91
CLU-301	DR350SR DR350SHR DR350SE R-W'94-98
CLU-330	GN250 F-R'85-95 GN250T'96
CLU-364	DRZ-400S'05-07 DRZ-400S'00-04 DRZ-400SM'05-07
CLU-317	GSF400'91-93 BANDIT
CLU-310	GS500E'89
CLU-311	GS500E'90-93
CLU-312	GS500E'94-00
CLU-351	GS500K1/K2/K3/K4/K5'01-05

STOCK NO	MODELS
CLU-335	GSX550EF/EUF/EG/EUG/EUH E22 GSX550ESF/EFF/ESG/EFG/ESH/EFH
CLU-309	GSX600F J-S'88-95
CLU-313	GSF600S'96-99
CLU-352	GSF600Y/YK1 BANDIT'00-01 GSF600YK2/YK3/YK4 BANDIT'02-04
CLU-353	GSX600FW-FK3 KATANA'98-03 GSX600FK4/FK5 KATANA'04-05 GSX750FW-FK3 KATANA'98-03 GSX750FK4/FK5 KATANA'04-05

CLU-354	GSX-R600K4/K5'04-05 GSX-R750K4/K5'04-05
CLU-365	DL650V'04-07
CLU-324	LS650S SAVAGE G-R'86-94 LS650P SAVAGE T-V'96-97
CLU-355	DR650RN/RP'92-93 DR650RER/RES'94-95
CLU-356	DR650RSM'91 DR650RSEM'91 DR650RSEN/RSEP'92-93
CLU-357	SV650X/Y/K1/K2'99-02
CLU-358	SV650K3/K4'03-04
CLU-359	SV650SX/SY/K1/K2'99-02
CLU-360	SV650SK3/SK4/SK5'03-05
CLU-366	XF650'97-01 FREEWIND
CLU-314	GSX-R600'97-00 GSX-R750 T-X'96-99
CLU-320	GSX-R750 J/K'88-89
CLU-302	GSX-R750 L/M'90-917
CLU-321	GSX-R750W N-P'92-93
CLU-303	GSX-R750W R/S'94-95
CLU-315	GSX750F'89-97
CLU-336	VX800 L-R'90-94
CLU-367	VL800'01-05
CLU-361	GSX-R600K2/K3'02-03 GSX-R750K2/K3'02-03 GSX-R1000K2'02
	KAWASAKI
CLU-452	GPZ550A1-A2'84-85
CLU-477	EN500 A3-A4'92-93
CLU-404	ER5'97-00 GPZ550B1-B5'88-93 GPZ500S E9/E10'02-93 GPZ500S A1-A3'87-89 GPZ500S E5-E7'98-00
CLU-405	KLE500'91-98
CLU-473	KLR600B6-B9'91-94
CLU-475	KL650A1-A3'87-89
CLU-478	ZZR600 D1-D3'90-92
CLU-401	Z650F2'81
CLU-402	Z750R1 GP'82
CLU-408	ZR750B1/B2 ZR550'91-99
CLU-407	ZR750'91-99
CLU-403	ZX600A1'85
CLU-406	ZZR600 E1-E13 '93-05

STOCK NO	MODELS
----------	--------

THROTTLE CABLE

	HONDA
THR-110	CB250N/400N'79 CB250NA/400NA'80
THR-1A08	
THR-122	CB250NDC'81
THR-1A16	
THR-1A04	CB400T2 CB250T1/T2
THR-104	
THR-1A63	CB500 T'96
THR-1A99	
THR-1A14	CB750FB/FC/F2C'81-82 CB750FA CB750FB/FC/F2C'81-82
THR-109	CB750FA,CB900FA/FB
THR-107	CB750FZ'79
THR-1A06	
THR-166	CB750F2'92-95
THR-167	
THR-101	CB750K1-K2
THR-1A01	
THR-111	CB900F2B/F2C'81-82
THR-1A15	
THR-108	CB900FZ'79
THR-1A07	
THR-154	CBR600F'91-94
THR-155	
THR-156	CBR600F'95-96
THR-157	
THR-158	CBR600F'97-98
THR-159	
THR-125	CBR900RR(N-S)92-95
THR-161	
THR-160	CBR900RR'96-99
THR-161	
THR-1A52	CBR1000F'87-88
THR-1A91	
THR-1A54	CBR1000F'89-92
THR-1A94	
THR-115	CBX550FC'82
THR-1A09	
THR-183	CBX1000'78-80
THR-1A74	
THR-112	CM400A(Z)'79 CM400T(Z)'79
THR-1A03	
THR-123	CM400T(A/B)'80-81 CM400A(A/B)'80-81
THR-1A17	
THR-106	CX500'79
THR-1A05	
THR-113	CX500C(B)'81 CX500C(A)'80
THR-1A18	
THR-116	FT500c
THR-1A10	
THR-114	GL500/I B/C'81-82
THR-1A79	
THR-192	GL1100'80-81
THR-1A35	
THR-1A60	VF750C'93-94
THR-1B3	
THR-1A41	VF1000Fe'84
THR-1A80	
THR-162	VT600'90-96
THR-163	

STOCK NO	MODELS
THR-1A49	XL600Rd/Ld'83
THR-1A85	
THR-146	XL600V'87-00, XRV650'88-89
THR-147	
THR-164	XRV750'93-00
THR-165	
THR-1B69	CBR600F1-F5'01-05
THR-1B70	CBR600F41-F44'01-04 CBR600FR1/FR2'01-02
THR-1B71	CBR600FY'00
THR-1B13	CBR600F4X'99
THR-1B14	CBR600FH/FJ/FK/FL'87-90
THR-1A22	
THR-1B16	CBR900RRY/RR1'00-01
THR-1B17	CBR900RE1'01
THR-1B18	CBR900RR2/RR3'02-03
THR-1B19	
THR-1B20	CBR900FP-FX'93-99
THR-1B21	
THR-1B22	CBR1100XXV BLACK BIRD'97
THR-1B23	CBR1100XXY BLACK BIRD'00
THR-1B24	CBR1100XX1-XX5 BLACK BIRD'01-05
THR-1B25	
THR-1B26	CB600FW/FX/FY/F1 HORNET'98-01
THR-1B27	CB600F2Y/F21 HORNET'00-01
THR-1B28	CB750F2T/F2V/F2W/F2X SEVEN FIFTY'96-99
THR-1B29	
THR-1B30	CB900F2/F3/F3/F4/F5 HORNET'02-05
THR-1B31	
THR-141	NTV600J/K'88-89
THR-1B33	NTV600M'91 NTV650J/K/L/M'88-91 NTV650P'93 NTV650S/T/V'95-97
THR-1B34	ST1100L/M/N/P/R/S'90-95
THR-1B35	ST1100T/V/W/X/Y/1/2'96-02 ST1100AN/AP/AR/AS/AT/AV'97-97 ST1100AW/AX/AY/A1/A2'98-02
THR-1B36	VF750CT/CV/CW/CX'96-99
THR-1B37	VF750CY/C1/C2'00-02 VF750C2V/C2W/C2X/C2Y'97-00 VF750CDT'96
THR-1A55	VFR750FL/FM/FN/FP'90-93
THR-1A95	
THR-1A61	VFR750FP/FS/FT/FV'94-97
THR-1B4	
THR-1B42	VFR800FiW/FiX/FiY'98-00
THR-1B43	
THR-1B44	VFR8002/3/4/5'02-05
THR-1B45	VFR800A2/A3/A4/A5'02-05
THR-150	VT1100CH/CJ SHADOW'87-88
THR-1A90	VT1100CN/CP SHADOW'92-93
THR-1B48	VT1100CV/CW SHADOW'97-98
THR-1B49	VT1100D2X SHADOW'99 VT1100C2S-C2X SHADOW'95-99
THR-1B50	VT1100C2Y-C23 SHADOW'00-03
THR-1B51	
THR-1B52	VT1100C3W-C32 SHADOW'98-02
THR-1B53	
THR-1B55	VT600CW/CX SHADOW'98-99
THR-1B56	VT600CDX SHADOW DLX'99 VT600CD2X SHADOW DLX'99
THR-1A62	VT600CDS-CDW SHADOW DLX'95-98
THR-1B5	

STOCK NO	MODELS
THR-146	XL600VY-V4 TRANSALP'00-04
THR-1B60	
THR-1B61	VTR1000FV/FW/FX/FY'97-00
THR-1B62	VTR1000F1-F5'01-05
THR-1B63	VTR1000SPY/SP1'00-01
THR-1A84	
THR-1B65	VTR1000SP2/SP3/SP4/SP5'02-05
THR-1B66	
THR-1B67	XL1000VX/VY/V1/V2 VARADERO'99-02
THR-1B68	
	YAMAHA
THR-230	FJ1200'86-90
THR-250	
THR-217	FZ750'86-87
THR-222	FZR1000'87-88
THR-245	
THR-226	FZR1000'89-90
THR-248	
THR-202	SR500'78-83
THR-2B01	
THR-212	SR500'84-89
THR-213	
THR-204	SR500'92-99
THR-2B03	
THR-214	XV535'89-94 XV535SE'88
THR-227	XV535'95-98 UP-HANDLE
THR-249	XV535DX'99-01 UP-HANDLE
THR-244	XT500'76-77
THR-215	XT600E'90-94
THR-216	XTZ660'91-93
THR-209A	XV1100 VIRAGO'89-91,94-97
THR-209B	XV750 VIRAGO'92,94-96
THR-225	XVZ12TD'88
THR-247	
THR-237	XT600'87-90 XT600Z TENERE'86-90
THR-2B10	XT600E'91-94 XTZ660 TENERE'91-96
THR-2B11	XT600E'95-02
THR-2B12	YZF-R6'99-02
THR-2B13	
THR-2B14	YZF-R6'03-05
THR-2B15	
THR-2B16	XVS650'98-00
THR-2B17	XVS650A'98-00
THR-239	XTZ750 SUPER TENERE'89-95
THR-241	TDM850'91-95
THR-2B20	TDM850'96-98
THR-2B21	TDM850'99-01
THR-2B22	TDM900'02-05
THR-238	FZR1000'91-95
THR-2B24	FZS1000 FAZER'01-05
THR-2B25	
THR-2B26	YZF-R1'98-01
THR-2B27	V-MAX 1200'86-93
THR-2B28	V-MAX 1200'96-01
THR-2B29	XJR1300'02-05
	SUZUKI
THR-360	DR750 J-K'88-89
THR-326	DR650R N-P'92-93 DR650RE R-S'94-95
THR-327	DR600S F'85
THR-328	

STOCK NO	MODELS
THR-348	DR800S M/N/P'91-93
THR-314	GS500E'89-96
THR-315	GS500E'94-00
THR-368	GSX1100F J-P'88-93
THR-358	GSX550EF/EUF'85-86 FOR E22 GSX550ESF/EFF/ESG/EFG/ESH/EFH
THR-311	GSX600F'88/89
THR-335	GSX600F'90-96
THR-336	GSX750F K-T'89-96
THR-323	GSX-R750H'85 FOR E18 MARKET GSX-R1100 G-J'86-88
THR-341	GSX-R750F'85
THR-342	
THR-343	GSX-R750 G/H'86-87
THR-344	
THR-331	GSX-R750 J/KL'88-89 GSX-R1100 K/L'89-90
THR-332	GSX-R750 L'90
THR-333	GSX-R750W N-S'92-95 (except E18/39)
THR-334	GSX-R1100W/P-T'93-96
THR-318	GSX-R600 V-Y'97-00
THR-319	GSX-R750 T-V'96-97
THR-357	GSX-R1100 M-N'91-92
THR-324	GSF400 BANDIT M-P'91-93
THR-325	
THR-316	GSF600S'95-99
THR-317	
THR-320	GSF1200'96-00
THR-321	
THR-339	LS650P SAVAGE G-R'86-94
THR-337	RF600F P '93
THR-338	
THR-349	RF600R R/S/T'94-96
THR-350	RF900R R/S/T'94-96
THR-355	VS1400 INTRUDER GLH-GLR'87-94
THR-356	VS1400 INTRUDER GLS'95
THR-369	VX800 L-R'90-94
THR-314	GS500EK/EL/EM/EN/EP/ER/ES/ET'89-96
THR-373	GS500K1/K2/K3/K4/K5'01-05
THR-374	
THR-375	GSF600Y/YK1 BANDIT'00-01
THR-376	GSF600YK2/YK3/YK4'02-04
THR-377	GSX600FW-FK3 BANDIT'98-03
THR-378	GSX600FK4/FK5 BANDIT'04-05 GSX750FW-FK3 BANDIT'98-03 GSX750FK4/FK5'04-05
THR-379	GSX-R600K2/K3'02-03
THR-380	
THR-326	DR650RN/RP'92-93 DR650RER/RES'94-95
THR-382	SV650X/Y/K1'99-01
THR-383	
THR-384	SV650SX/SY/SK1/SK2'99-02
THR-385	
THR-336	GSX750FK-FT KATANA'89-96
THR-387	GSX-R1100S/T'95-96
THR-388	
THR-389	GSX-R750W/X'98-99
THR-390	
THR-391	GSX-R750Y/K1'00-01
THR-392	GSX-R1000K1'01
THR-393	GSX-R750K2/K3'02-03
THR-394	GSX-R1000K2'02
THR-395	GSF1200K1-K5 BANDIT'01-05
THR-396	

STOCK NO	MODELS
THR-397	GSX1300X/Y/K1 NAYABUSA'99-01
THR-398	
THR-399	GSX1300K2/K3 HAYABUSA'02-03
THR-3A01	
	KAWASAKI
THR-4D05	GPZ550A1-A2'84-85
THR-415	GPZ600RA3-A4'87-88
THR-416	
THR-445	KLR600 B6-B9'91-94
THR-444	
THR-403	Z1000A1'78
THR-4D02	
THR-401	Z650F2'81
THR-4D01	
THR-4D14	ZX600D1/D2/D3 NINJA'90-92
THR-4D15	
THR-4D16	ZX600E1/E2/E3/E4/E5/E6 NINJA'93-98
THR-4D17	ZX600E7/E8/E9/E10/E11 NINJA'99-03
THR-4D18	KL650A1/A2/A3'87-88
THR-4D19	KL650C1-C5 KLR'95-99 KL650C7-C10 KLR'01-04
THR-4D20	ZR750C1/C2/C3/C4 ZEPHYR'91-94
THR-4D21	

STARTER CABLE

HONDA

STC-101	XL125V'01-06
STC-102	VF750C'93-96
STC-103	VTR1000SP'00-06
STC-104	CB1100SF'00-01
STC-105	CRF250R'04-07
STC-106	CRF450R'02-03
STC-107	CRF450R'04

YAMAHA

STC-201	FZR600'89-93
STC-202	FZS600'98-99 FZS600S'00-01
STC-203	XJ900'84-94

SUZUKI

STC-301	RGV250'93-96
STC-302	GSF600'00-04
STC-303	XF650'97-01 FREEWIND
STC-304	GSX750F'89-96
STC-305	GSX750'98-01
STC-306	VZ800'97-02
STC-307	GSX1100F'88-93
STC-308	GSXR1100'86-88
STC-309	GSF1200'01-05

KAWASAKI



STC-401	VN1500E1/E2'98-99
STC-402	VN800B1-B9F'96-04
STC-403	VN1500N1H-N3H'00-02 VN1500L1-L4'00-03 VN1500J1'99 VN1500P1-P2'02-03 VN1600A1H-A6F'03-06 VN1600D1H'05 VN1600D6H'06 VN1600B1H-B6F'04-06
STC-404	ER-5'97-00 A1-A4
STC-405	ZX600F1-F3(ZX-6R)'95-97 ZX600E1-E13'93-05 ZZR600
STC-406	KL650A1-A3'87-89 KL650C1-C9'95-03

STOCK NO	MODELS
STC-407	ZX750F1-F3'87-89 GPX750R
	ZX750H1-H2'89-90
	ZX750J1-J2'91-92
	ZX1100C1-C3'90-92 ZZR1100
	ZX1100D1-D7'93-99 ZZR1100
STC-408	ZX900C1-C2 ZX9R'98-99
STC-409	ZG1000A11'96-97
	ZG1000'03
STC-410	ZR1100A1-A4'92-95
STC-411	ZX1100E1-E2'95-97
	ZR1100DE1-D3'97-99
	ZR1200C1-C3'01-04
	ZR1200A1P-A6F'01-06
	ZR1200B1P-B4H'01-04

WHEEL BALANCE WEIGHTS







for MOTORCYCLE

MC ID	WEIGHT	MODEL APPLICATION	MODEL APPLICATION	MODEL APPLICATION
MATERIAL: LEAD				
WBW-201-10	10G			
WBW-201-20	20G			
WBW-201-30	30G			
				
for CAST WHEEL		YAMAHA (77-81) XS400D/E/F/G/H (83-84) XS400J/K MAXIM (80-81) XS400SG/SH (82-83) XS400RJ/RK SECA (78-81) XS650SE/SE/SG/SH (77-79) XS750D/E/F (78-79) XS750SE/SF (80-81) XS850G/H (1980) XS850SG/LG (1981) XS850SH/LH (78-81) XS1100E/F/G/H (79-81) XS1100SF/SG/SH (80-81) XS1100LG/LH (81-83) XJ550H/J/K MAXIM	YAMAHA (81-83) XJ550RH/RJ/RK SECA (80-82) XJ650G/H/J MAXIM (1981) XJ650LH MIDNIGHT (1982) XJ650RJ SECA (82-83) XJ650LJ/LK SECA- (1983) XJ650K MAXIM (82-83) XJ750J/K MAXIM (81-83) XJ750RH/RJ/RK SECA (1983) XJ750MK MIDNIGHT- (1985) XJ750RN (1982) XJ1100J MAXIM (81-83) XV750H/J/K VIRAGO (1983) XV750MK VIRAGO (82-83) XV920RH/RJ VIRAGO	(82-83) XV920J/K VIRAGO (1983) XV920MK MIDNIGHT- VIRAGO (82-83) XV1000SE VIRAGO (82-83) XZ550RJ/RK VISION (1983) XVZ12TK VENTURE (1983) XVZ12TDK VENTURE ROYAL (1984) XVZ12L/KC2 VENTURE (1984) XVZ12DL/DKC2 VENTURE ROYAL (1985) XVZ12DN VENTURE (87-88) XVZ13T/U VENTURE (86-93) XVZ13DS/DT/DU/DW/DA/DB/DC /DE VENTURE ROYAL (2001) YZF-R1N (2001) YZF-R1SN CHAMPIONS LTD ED
MATERIAL: LEAD				
WBW-301-10	10G			
WBW-301-20	20G			
WBW-301-30	30G			
MATERIAL STEEL				
WBW-304-10	10G			
WBW-304-20	20G			
WBW-304-30	30G			
for CAST WHEEL		(85-88) GS450LF/LG/LH/LJ (89-06) GS500EK-K6 (85-86) GS550LF/LG (83-86) GS550ES3/ESE/EF/ESF/ESG (1985) GS700EF/ESF (1982) GS1000SZ KATANA (1983) GS1100SD (82-83) GS1100EZ/ED/ESD (83-86) GS1150ES3/ESE/EF/ESF/EF2/EG /ESG (88-97) GSX600FJ-FV KATANA (98-06) GSX600FW-K6 KATANA (89-97) GSX750FK-FV KATANA (98-06) GSX750FW-K6 KATANA (98-00) GSX750W/X/Y	SUZUKI (88-93) GSX1100FJ-FP KATANA (91-94) GSX1100GM/GN/GP/GR (1999) GSX1200X (92-93) GSX-R600WN/WP (94-96) GSX-R600R/S/T (97-00) GSX-R600V/W/X/Y (88-96) GSX- R750J/K/L/M/N/P/R/S/T (97-98) GSX-R750V/W (86-92) GSX- R1100G/H/J/K/L/M/N (93-98) GSX-R1100P/R/S/T/V/W (99-06) GSX1300RX-K6 HAYABUSA (91-93) GSF400M/N/P BANDIT (95-98) GSF600SS/ST/SV/SW BANDIT (99-042) GSF600SX-K4 BANDIT	(95-02) GSF600US-UK2 BANDIT (96-00) GSF1200ST-SY BANDIT (01-05) GSF1200SK1/SK5 BANDIT (98-03) TL1000RW-RK3 (97-01) TL1000SV/SK1 (93-96) RF600RP/RR/RS/RT (94-97) RF900RR/RS/RT/RV (97-98) VS800V/W MARAUDER (FRONT WHEEL) (97-03) VZ800V-K2 MARAUDER (FRONT WHEEL) (90-93) VX800L/M/N/P (86-88) VS1400GDG-GDJ (99-06) SV650X/Y/K1/K2/K3-K3 (99-06) SV650SX/SY/SK1/SK2/SK6
MATERIAL STEEL				
WBW-303-10	10G			
WBW-303-20	20G			
WBW-303-30	30G			
for CAST WHEEL		(01-06)GSX-R600K1-K6 (04-07) DL1000K2-K6 (00-06) GSX-R750 Y-K6	SUZUKI (03-05)SV1000K3-K5 (02-06) GSX-R1000K2-K6 (03-04) AN650 BURGMAN SCTR	(02-06)DL1000 (04) VN1600B1

MC ID	WEIGHT	MODEL APPLICATION	MODEL APPLICATION	MODEL APPLICATION
MATERIAL : LEAD				
WBW-401-10	10G			
WBW-401-20	20G			
WBW-401-30	30G			
MATERIAL : STEEL				
WBW-404-10	10G			
WBW-404-20	20G			
WBW-404-30	30G			
for CAST WHEEL			KAWASAKI	
	(87-00) EX250F1-F14 NINJA	(93-94) ZX750M1/M2 NINJA	(99-03) ZR750F1-F5 ZR-7	
	(90-03) EX250H1-H14 NINJA	(93-95) ZX750L1-L3 NINJA	(01-03) ZR750H1-H3 ZR-7S	
	(87-93) EX500A1-A7	(91-92) ZX750J1/J2 NINJA	(2003) ZR1000A1H Z1000	
	(88-91) EX500B1-B4 GSZ500S	(91-92) ZX750K1/K2 NINJA	(97-00) ZR1100C1-C4 ZRX1100	
	(94-02) EX500E1-E9 GSX500S	(96-97) ZX750N1/N2 NINJA	(97-01) ZR1100D1-D4 ZRX1100	
	(94-00) EX500D1-D7	(96-00) ZX750P1-P5 NINJA	(01-03) ZR1200A1P/A2P/A3P ZRX1200R	
	(90-96) EN500A1-A7 VULCAN	(86-91) ZX750A1-A8 NINJA	(01-03) ZR1200B1P/B2P/B3P ZRX1200S	
	(91-92) ZX400L1/L2 NINJA	(94-97) ZX900B1-B4 NINJA	(01-03) ZR1200C1P/C2P/C3P ZRX1200	
	(84-86) ZX550A1-A3 GPz	(98-99) ZX900C1/C2 NINJA	(86-87) ZL600A1/A2 ELIMINATOR	
	(85-87) ZX600A1-A3 NINJA	(00-02) ZX900E1P/E2P NINJA	(85-86) ZL900A1/A2 ELIMINATOR	
	(1987) ZX600B1 NINJA	(2002) ZX900F1P NINJA	(1987) ZL1000A1	
	(88-96) ZX600C1-C9 NINJA	(02-03) ZX900F1H/F2H NINJA	(86-93) ZG1000A1-A8 CONCOURS	
	(90-93) ZX600D1-D4 NINJA	(86-87) ZX1000A1/A2 NINJA	(1986) ZG1200A1 VOYAGER XII	
	(95-97) ZX600F1-F3 NINJA	(88-90) ZX1000B1-B3 NINJA	(87-00) ZG1200B1-B14 VOYAGER XII	
	(98-99) ZX600G1/G2 NINJA	(83-84) ZX1100A1/A2 GPz	(84-85) ZN700A1/A2 LTD	
	(00-01) ZX600J1H/J2H NINJA	(95-97) ZX1100E1-E3 GPZ	(83-84) ZN1100A1/A2 LTD	
	(2002) ZX600K1H NINJA	(90-93) ZX1100C1-C4 NINJA ZZ-R1100	(1985) VN700A1 VULCAN	
	(02-03) ZX636A1P/B1P NINJA	(93-00) ZX1100D1-D8 NINJA ZZ-R1100	(86-00) VN750A1-A16 VULCAN	
	(89-90) ZX750H1/H2 NINJA	(00-01) ZX1200A1H/A2H NINJA	(87-98) VN1500A1-A12 VULCAN	
	(83-85) ZX750A1-A3 GPz	(02-03) ZX1200B1H/B2H NINJA	(2000) VN1500L1 VULCAN	
	(84-86) ZX750G1-G3 NINJA	(02-03) ZX1200C1H/C2H NINJA ZZR1200	NOMAD Fi	
	(87-90) ZX750F1-F4 NINJA	(90-94) ZR5500B1-B5 ZEPHYR	(99-00) VN1500G1/G1A/G2A VULCAN NOMAD	
	(84-85) ZX750E1/E2 TURBO	(91-94) ZR750C1-C4 ZEPHYR	(98-99) VN1500G1/G2 CLASSIC	
			TOURER	
			(00-03) VN1500L1H-L4H CLASSIC	
			TOURER	
			(02-03) VN1500P1H/P2H MEAN	
			STREAK Fi	
			(03-06)	
			VN1600A1/A6/D1/D6/B6	

MATERIAL: LEAD				
WBW-403-10	10G			
WBW-403-20	20G			
WBW-403-30	30G			
	(80-83)KZ440A1-A4 LTD	(1984)KZ700A1	(77-80)KZ1000B1-B4 LTD	
	(80-83)KZ550A1-A4	(1980)KZ750G1 LTD	(1980)KZ1000G1	
	(1981) KZ550D1 GP	(1983)KZ750F1 LTD	(81-83)KZ1000J1-J3	
	(80-83)KZ550C1-C4 LTD	(80-83)KZ750H1-H4	(82-83)KZ1000R1/R2 REPLICIA	
	(1983)KZ550M1 LTD	(80-82)KZ750E1-E3	(81-82)KZ1100A1-A3	
	(83-84)KZ550F1/F2 LTD	(83-84)KZ750K1/K2 LTD	(82-83)KZ1100D1/D2 SPECTRE	
	(82-83)KZ550H1/H2 GP	(1983)KZ750L3	(81-82)KZ1100B1/B2 GP	
	(78-79)KZ650D1/D2	(82-83)KZ750N1/N2 SPECTRE	(1983)KZ1100L1 LTD	
	(77-79)KZ650C1-C3 CUSTOM	(1982)KZ750R1	(79-82)KZ1300A1-A4	
	(1980)KZ650F1	(1978)KZ1000D1 Z1-R	(1980)KZ1300B2 TROURING	
	(1980)KZ650E1 LTD	(77-80)KZ1000A1-A4	(83-88)ZN1300A1-A6 VOYAGER	
	(1983)KZ650H3 CSR	(79-80)KZ1000E1/E2 ST&SHAFT		

MATERIAL : LEAD				
WBW-402-10	10G			
WBW-402-20	20G			
WBW-402-30	30G			
for SPOKE WHEEL				
	(96-97) ZL600B2/B3 ELIMINATOR	(73-75) Z1/A/B	(87-92) VN1500B1-B6 VULCAN SE	
	(87-91) KL650A1-A5	(76-77) KZ900A4/A5	(94-97) VN1500C1-C4 VULCAN	
	(92-98) KL650A6-A12	(81-82) KZ1000M1/M2 CSR	(96-97) VN1500D1/D2 VULCAN	
	(89-91) KL650B1-B3 TENGAI	(99-02) EJ650A1-A4 W650	CLASSIC	
	(95-96) KL650C1/C2 KLR	(99-03) EJ650C1-C5 W650	(98-00) VN1500E1-E3 VULCAN	
	(2003) KL650C9 KLR	(96-03) EN500C1-C8 VULCAN LTD	CLASSIC	
	(93-96) KLX650C1-C4	(95-00) VN800A1-A6 VULCAN	(96-03) VN1500C1-C8 VULCAN	
	(81-82) KZ650H1/H2	(96-03) VN800B1-B8 VULCAN	LTD	
	(76-79) KZ750B1-B4	(99-00) VN800C1/C2 VULCAN	(01-02) VN1500R1H/R2H VULCAN	
	(1982) KZ750M1 CSR	DRIFTER	DRIFTER	
		(01-02) VN800E1/E2 VULCAN	(99-00) VN1500J1/J2 VULCAN	
		DRIFTER	DRIFTER	
			(00-02) VN1500N1H/N2H/N3H	
			CLASSIC Fi	

MC ID	WEIGHT	MODEL APPLICATION	MODEL APPLICATION	MODEL APPLICATION
MATERIAL: LEAD				
WBW-202-10	10G			
WBW-202-20	20G			
WBW-202-30	30G			
MATERIAL: STEEL				
WBW-203-10	10G			
WBW-203-20	20G			
WBW-203-30	30G			
for CAST WHEEL		YAMAHA		KAWASAKI
		(1982) RD125LC	(83-85) XJ900	(93-03) ZX600E1-E11
		(95-97) TZR125	(95-02) XJ900S	(92-93) ZR1100A1/A2
		(1982) RD250LC	(2003) TDM900R	(2003) ZG1000A18
		(1988) TZR250	(02-06) YZF-R1	(05) ZX600N1H ZX-6RR
		(84-85) RD250LC	(05-06) MT-01	(05) ZX636C1H ZX-6RR
		(1982) RD350LC	(06) FZ1-N FAZER	(06) ZX636C6F ZX-6R
		(84-85) RD350LC	(06) FZ1-S	(06) ER-6F A6F
		(1988) RD350LCF	(1985) XV1000N	ER-6F B6F
		(88-90) FZR400	(2001) FZS1000N FZ1	(06) ER-6N A6S
		(01-06) YZF-R6	(2001) FZS1000P FZ1	(06) ER-6N B6F
		(04-06) FZ6-N	(2002) FZS1000S	(06) Z750 J6F
		(04-06) FZ6-S FAZER	(01-05) FZS1000	(05) Z750S K1H
		(05-06) FZ6-NS	(2002) YZF-R1P	(06) Z750S K6F
		(2001) YZF-R6N	(84-85) XV1000L/C	(06) ZX1000D6F ZX10R
		(2001) YZF-R6SN CHAMPIONS		
		LTD ED	(87-95) FZR1000	(04-05) ZX1000C1/C2
		(2002) YZF-R6P	(96-01) YZF1000R	(04-05) VN2000A1/A2
		(2002) YZF600R/ RP	(98-01) YZF-R1	(06) VN2000A6F
		(2003) FZS600	(84-85) FJ1100L/N	
		(2003) FZS600R	(86-93)	
		(84-85) FJ600L/N	(94-97) XV1100F/G/H/J	
		(86-88) FZ600S/T/U	(2002) VMX12P V-MAX	
			(85-92) VMX12N/S/T/U/W/A/B/D	
		(91-99) FZR600R	V-MAX	
			(93-01)	
		(92-99) XJ600SD-SL SECA II	VMX12E/F/G/H/J/K/L/M/N V-	
		(95-02) YZF600R	MAX	
		(97-02) XJ600N	(86-93) FJ1200	
		(99-00) YZF-R6	(95-98) XJR1200	
		(1985) XJ700N/XN MAXIM	(97-98) XJR1200SP	
		(1986) XJ700S/XS MAXIM	(02-04) XJR1300	
		(86-87) FZ700S/T	(03-06) FJR1300A	
		(1988) FZ750U	(1999) XJR1300SP	
		(1999) YZF-R7	(2000) XVZ1300A	
		(85-86) FZ750N/S	(2000) XVZ13TF	
			(2001) XJR1300N	
		(87-90) FZR750R	(2001) XVZ13LTN ROYAL STAR	
		(88-92) XV750U/W/A/B/D	TOUR DELUXE	
			(2001) XVZ13TFN VENTURE	
		(93-96) XV750E/F/G/H VIRAGO	(2002) XVZ13TFP ROYAL STAR	
			VENTURE	
		(94-97) YZF750R	(2002) XVZ13TFSP ROAD STAR	
		(96-97) XV750H1/J1 VIRAGO	MIDNIGHT-VENTURE	
			(2003) XJR1300R	
		(91-99) TDM850	(96-97)	
		(03-06) TDM900	XVZ130AH/ATH/AJ/ATJ/LTJ	
		(05-06) TDM900A	ROYAL STAR	
			(99-01) XJR1300	
		(1983) XJ900RK SECA	(03-04)XV1700 WARRIOR	
		(1985) XJ900FN/RN	(2002) XV17PCP ROAD STAR	
			WARRIOR	
			(06) XV1900	

REMARKS: WBW-302-10/20/30 ARE NO LONGER AVAILABLE

DRIVE CHAIN CUTTER



DESCRIPTION	CHAIN SIZE	STOCK NO
CHAIN CUTTER	35-40	CCT-104
CHAIN CUTTER	50	CCT-105
CHAIN CUTTER	60	CCT-106
CHAIN CUTTER & RIVETTER	35-40	CCT-110
CHAIN CUTTER & RIVETTER	50	CCT-111
CHAIN CUTTER & RIVETTER	60	CCT-112

(I) CUTTING

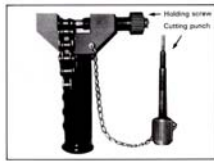

① Insert the chain on the chain cutter and tighten the holding screws.



② Insert the cutting punch.



③ Hammer cutting punch several times, then be sure to tighten the holding screw again. Then hammer repeatedly as photo till the pin pops out.



④ After the pin pops out, release screw and remove the chain.

(II) RIVETING



For Riveting, change chain cutter for Rivet punch and reverse sequence for cutting.

HAMMER SIZE:

No. 35 / 40 1. $\frac{1}{2}$ lbs Hammer
No. 50UP 2 lbs Hammer

NO WARRANTY FOR PROPER RIVETING AND NO INDEMNITY FOR ANY LOSS OR DAMAGE, DIRECT OR INDIRECT, BY IMPROPER RIVETING.

CCT-114

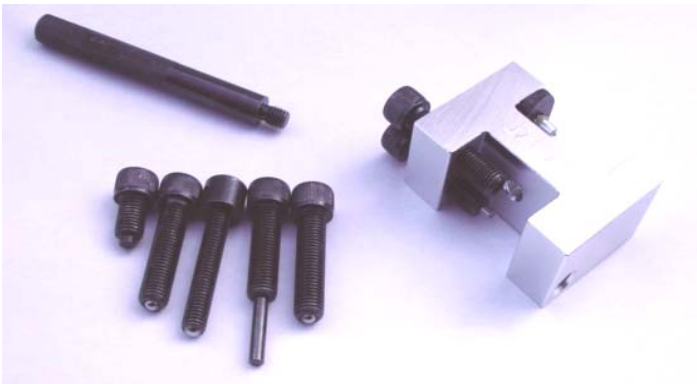

AUTOMOBILE HORNS



MICROPHONE TYPE

VF

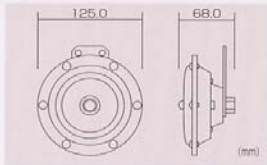

BLACK RED

MODEL	VOLT	AMP	TONE	dB	Hz	STANDARD PACKING (In Carton Box)		
						CONT(pcs)	CUBE(efl)	G.W.(kgs)
VFD-125	12	8.0	DUAL	117	370 / 290	12	1.7	21.0
VFD-125	24	6.0	DUAL	117	370 / 290			
VFL-125	12	4.0	LOW	115	290	20	1.6	18.0
VFH-125	12	4.0	HIGH	115	370			
VFL-125	24	3.0	LOW	115	290			
VFH-125	24	3.0	HIGH	115	370			



MICROPHONE TYPE

KF

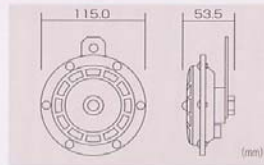

BLACK RED YELLOW BLUE GREEN

MODEL	VOLT	AMP	TONE	dB	Hz	STANDARD PACKING (In Carton Box)		
						CONT(pcs)	CUBE(efl)	G.W.(kgs)
KFD-115	12	7.0	DUAL	114	350 / 290	12	1.3	13.0
KFD-115	24	4.0	DUAL	114	350 / 290			
KFL-115	12	3.5	LOW	112	290	24	1.0	13.0
KFH-115	12	3.5	HIGH	112	350			
KFL-115	24	2.0	LOW	112	290			
KFH-115	24	2.0	HIGH	112	350			

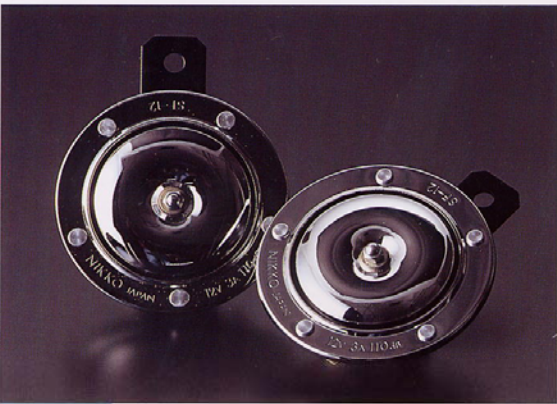

MICROPHONE TYPE

SF

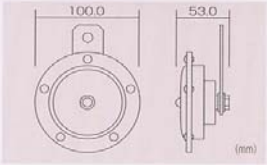

BLACK CHROME GAL

MODEL	VOLT	AMP	TONE	dB	Hz	STANDARD PACKING (In Carton Box)		
						CONT(pcs)	CUBE(efl)	G.W.(kgs)
SFD-100	12	6.0	DUAL	112	415 / 350	25	1.5	21.0
SFD-100	24	5.0	DUAL	112	415 / 350			
SFL-100	12	3.0	LOW	110	350	50	1.6	21.0
SFH-100	12	3.0	HIGH	110	415			
SFL-100	24	2.5	LOW	110	350			
SFH-100	24	2.5	HIGH	110	415			



MICROPHONE TYPE

CF₃

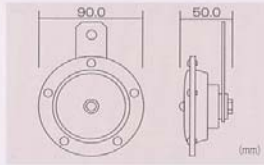

BLACK ZNC GAL

MODEL	VOLT	AMP	TONE	dB	Hz	STANDARD PACKING (In Carton Box)		
						CONT(pcs)	CUBE(efl)	G.W.(kgs)
CFD-90	12	6.0	DUAL	110	415 / 350	25	1.5	16.0
CFD-90	24	4.0	DUAL	110	415 / 350			
CFL-90	12	3.0	LOW	108	350	50	1.2	16.0
CFH-90	12	3.0	HIGH	108	415			
CFL-90	24	2.0	LOW	108	350			
CFH-90	24	2.0	HIGH	108	415			

AUTOMOBILE HORNS



MICROPHONE TYPE

CF4

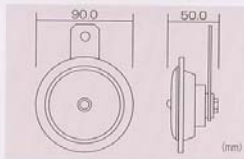

MODEL	VOLT	AMP	TONE	dB	Hz	STANDARD PACKING (In Carton Box)		
						CONT(PCS)	CUBE(FT)	G.W.(KGS)
CF4D	12	6.0	DUAL	110	415 / 350	25	1.5	16.0
CF4D	24	4.0	DUAL	110	415 / 350			
CF4L	12	3.0	LOW	108	350	50	1.2	16.0
CF4H	12	3.0	HIGH	108	415			
CF4L	24	2.0	LOW	108	350	50	1.2	16.0
CF4H	24	2.0	HIGH	108	415			



MICROPHONE TYPE

ZF

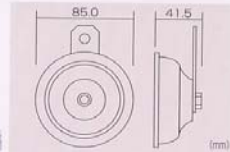

MODEL	VOLT	AMP	TONE	dB	Hz	STANDARD PACKING (In Carton Box)		
						CONT(PCS)	CUBE(FT)	G.W.(KGS)
ZFD-85	12	5.0	DUAL	112	415 / 370	25	1.0	11.0
ZFD-85	24	3.0	DUAL	112	415 / 370			
ZFL-85	12	2.5	LOW	110	370	50	1.0	11.0
ZFH-85	12	2.5	HIGH	110	415			
ZFL-85	24	1.5	LOW	110	370	50	1.0	11.0
ZFH-85	24	1.5	HIGH	110	415			



MICROPHONE TYPE

YA

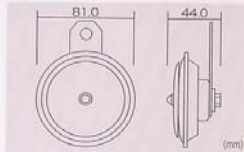

MODEL	VOLT	AMP	TONE	dB	Hz	STANDARD PACKING (In Carton Box)		
						CONT(PCS)	CUBE(FT)	G.W.(KGS)
YAD	12	6.0	DUAL	110	390 / 330	25	1.5	13.0
YAL	12	3.0	LOW	108	330			
YAH	12	3.0	HIGH	108	390	50	1.2	13.0



TURBINE TYPE

SP

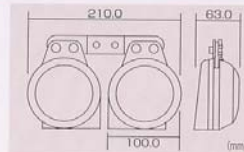

MODEL	VOLT	AMP	TONE	dB	Hz	STANDARD PACKING (In Carton Box)		
						CONT(PCS)	CUBE(FT)	G.W.(KGS)
SPD	12	8.0	DUAL	108	415 / 350	12	1.0	17.0
SPD	24	4.0	DUAL	108	415 / 350			
SPL	12	4.0	LOW	106	350	24	1.0	14.0
SPH	12	4.0	HIGH	106	415			
SPL	24	2.0	LOW	106	350	24	1.0	14.0
SPH	24	2.0	HIGH	106	415			



AUTOMOBILE HORNS



FANFARE TYPE

JP

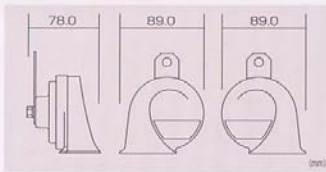

MODEL	VOLT	AMP	TONE	dB	Hz	STANDARD PACKING (In Carton Box)		
						CONT (pcs)	CUBE (cf)	G.W.(kgs)
JPD	12	8.0	DUAL	110	480 / 400	24	2.5	21.0
JPL	12	4.0	LOW	108	400	48	2.5	21.0
JPH	12	4.0	HIGH	108	480			



FANFARE TYPE

FP

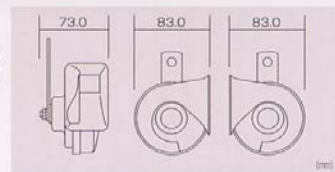

MODEL	VOLT	AMP	TONE	dB	Hz	STANDARD PACKING (In Carton Box)		
						CONT (pcs)	CUBE (cf)	G.W.(kgs)
FPD	12	8.0	DUAL	110	500 / 410	24	1.3	18.0
FPL	12	4.0	LOW	108	410	48	1.3	18.0
FPH	12	4.0	HIGH	108	500			

MOTORCYCLE HORNS



MICROPHONE TYPE

CFc

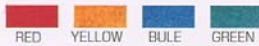
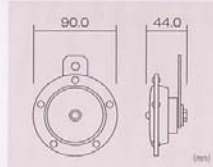

MODEL	VOLT	AMP	TONE	dB	Hz	STANDARD PACKING (In Carton Box)		
						CONT (pcs)	CUBE (cf)	G.W.(kgs)
CFD-90	6	6.0	DUAL	110	415 / 350	25	1.5	20.0
CFD-90	12	5.0	DUAL	110	415 / 350			
CFL-90	6	3.0	LOW	108	350	50	1.2	18.0
CFH-90	6	3.0	HIGH	108	415			
CFL-90	12	2.5	LOW	108	350			
CFH-90	12	2.5	HIGH	108	415			



MICROPHONE TYPE

CFB

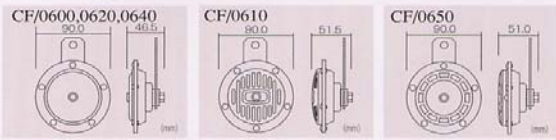

MODEL	VOLT	AMP	TONE	dB	Hz	STANDARD PACKING (In Carton Box)		
						CONT (pcs)	CUBE (cf)	G.W.(kgs)
CFD	6	6.0	DUAL	110	415 / 350	25	1.5	16.0
CFD	12	5.0	DUAL	110	415 / 350			
CFL	6	3.0	LOW	108	350	50	1.2	16.0
CFH	6	3.0	HIGH	108	415			
CFL	12	2.5	LOW	108	350			
CFH	12	2.5	HIGH	108	415			

MOTORCYCLE HORNS



MICROPHONE TYPE

YF

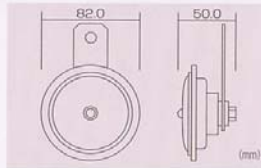

MODEL	VOLT	AMP	TONE	dB	Hz	STANDARD PACKING (In Carton Box)		
						CONT(PCS)	CUBE (cft)	G.W.(kgs)
YFD-85	6	6.0	DUAL	108	415 / 350	25	1.5	14.0
YFD-85	12	5.0	DUAL	108	415 / 350			
YFL-85	6	3.0	LOW	106	350	50	1.2	14.0
YFH-85	6	3.0	HIGH	106	415			
YFL-85	12	2.5	LOW	106	350			
YFH-85	12	2.5	HIGH	106	415			



MICROPHONE TYPE

MF

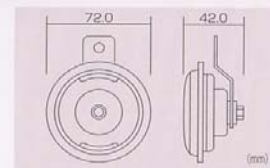

MODEL	VOLT	AMP	TONE	dB	Hz	STANDARD PACKING (In Carton Box)		
						CONT(PCS)	CUBE (cft)	G.W.(kgs)
MF	6	1.5	HIGH	102	440	100	1.5	17.0
MF	12	1.5	HIGH	102	440			



MICROPHONE TYPE

GF/HDM

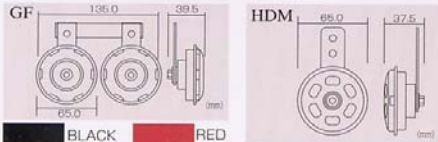

MODEL	VOLT	AMP	TONE	dB	Hz	STANDARD PACKING (In Carton Box)		
						CONT(PCS)	CUBE (cft)	G.W.(kgs)
GFD-65	6	3.0	DUAL	105	415 / 460	30	1.5	12.0
GFD-65	12	3.0	DUAL	105	415 / 460			
HDM	6	1.5	HIGH	102	460	100	1.5	16.0
HDM	12	1.5	HIGH	102	460			



TURBINE TYPE

YP

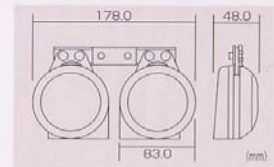

MODEL	VOLT	AMP	TONE	dB	Hz	STANDARD PACKING (In Carton Box)		
						CONT(PCS)	CUBE (cft)	G.W.(kgs)
YPD	6	5.0	DUAL	100	490 / 460	25	1.3	19.0
YPD	12	4.0	DUAL	100	490 / 460			
YPL	6	2.5	LOW	98	460	50	1.2	17.0
YPH	6	2.5	HIGH	98	490			
YPL	12	2.0	LOW	98	460			
YPH	12	2.0	HIGH	98	490			



MOTORCYCLE HORNS



TURBINE TYPE

YP-85

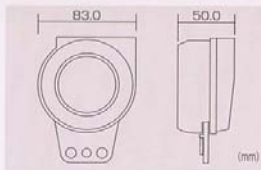

MODEL	VOLT	AMP	TONE	dB	Hz	STANDARD PACKING (In Carton Box)		
						CONT(PCS)	CUBE (cft)	G.W.(kgs)
YPD-85	6	5.0	DUAL	100	490 / 460	25	1.5	19.0
YPD-85	12	4.0	DUAL	100	490 / 460			
YPL-85	6	2.5	LOW	98	460	50	1.2	17.0
YPH-85	6	2.5	HIGH	98	490			
YPL-85	12	2.0	LOW	98	460			
YPH-85	12	2.0	HIGH	98	490			

BUZZERS



SIGNAL BUZZER

SB

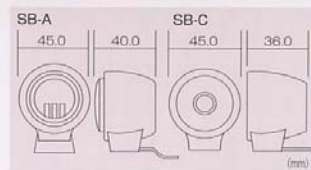

MODEL	VOLT	AMP	TONE	dB	Hz	STANDARD PACKING (In Carton Box)		
						CONT(PCS)	CUBE (cft)	G.W.(kgs)
SB-A	6	0.18	—	80	650	100	1.0	12.0
SB-A	12	0.08	—	80	650			
SB-C	6	0.18	—	85	650			
SB-C	12	0.08	—	85	650			

BUZZERS



BACK-UP BUZZER

BB

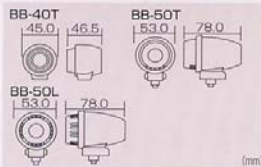

MODEL	VOLT	AMP	TONE	dB	Hz	STANDARD PACKING (In Carton Box)		
						CONT(PCS)	CUBE (cft)	G.W.(kgs)
BB-40T	12	0.1	—	85	750	100	1.0	12.0
BB-50T	12	0.2	—	85	550			
BB-50T	24	0.1	—	85	550	100	1.4	19.0
BB-50L	12	0.2	—	95	700			
BB-50L	24	0.1	—	95	700			

PIEZO ELECTRONIC BUZZERS



BACK-UP BUZZER

EBL/EBS

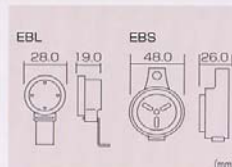

MODEL	VOLT	AMP	TONE	dB	Hz	STANDARD PACKING (In Carton Box)		
						CONT(PCS)	CUBE (cft)	G.W.(kgs)
EBL	12	0.05	—	80	3,500	100	1.0	5.0
EBL	24	0.05	—	80	3,500			
EBS(L)	12-24	0.05	—	85	550	100	1.0	7.0
EBS(H)	12-24	0.05	—	95	2,600			

BURGLAR ALARM



SUPER GUARD

SG

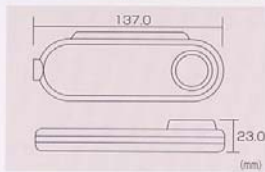

FEATURES:

The system raises an alarm immediately with slightest shock or vibration, compact, yet, loudest alarm sound from this size, simple installation, timer function and re-arming.

A main key of motorcycle is used for ON/OFF of this system by connecting the lead wires.

By the built-in back up system with 2 Lithium Batteries provided, the alarm function keeps working even if the lead wires are cut off.

This system has the superior shock proof and water resistance.

MODEL	VOLT	AMP	TONE	dB	Hz	STANDARD PACKING (In Carton Box)		
						CONT (pcs)	CUBE (cft)	G.W.(kgs)
SG-103	12	0.30	—	90	2,600	30	1.0	7.0

CHAIN & WIRE LOCKS

 <p>NC-06B-750 SIZE / $\phi 4.5 \times 750$mm COL / BLUE</p> <p>NC-06BB-750 SIZE / $\phi 4.5 \times 750$mm COL / BLACK</p>	 <p>N-260W-500 SIZE / $\phi 10 \times 500$mm COL / BLACK, PURPLE, GREEN, YELLOW</p> <p>N-260W-900,1800 SIZE / $\phi 10 \times 900, 1,800$mm COL / BLACK, PURPLE, GREEN, YELLOW</p>
 <p>N-310W-900 SIZE / $\phi 15 \times 900$mm COL / BLACK</p>	 <p>N-510 SIZE / $100.5 \times 24 \times 64.6$mm COL / SILVER</p>

AIR CUT OFF VALVE

To prevent "after-burn" generated by a lean fuel mixture when closing the throttle, the air cut-off valve temporarily closes the slow-jet air passage and creates an instantly richer mixture.



ACV-001M	YAMAHA		
	YFM400AR/AS KODIAK 400 2WD	03-04	
	YFM400FAHR/FAHS KODIAK 400 4WD	03-04	
	YFM400FAR/FAS KODIAK 400 4WD	03-04	
	YFM450FAR KODIAK 450 4WD	2003	
	YFM450FAHS KODIAK 450 AUTO 4X4 HARDWOODS	2004	
	YFM450FAHR KODIAK 450 REAL TREE	2003	
	YFM450FAS KODIAK 450 ATUO 4X4	2004	
	YFM660FHS GRIZZLY 660	2004	
	HARDWOODS HUNTER CAMO		
	YFM660FHSWL GRIZZLY 660 AUTO 4X4 WETLAND	2004	
	YFM660FLES GRIZZLY 660 AUTO 4X4 LIMITED ED	2004	
	YFM660FS GRIZZLY 660	2004	
	YFM660FP GRIZZLY	2002	
	YFM660FPS GRIZZLY METALLIC SILVER	2002	
	YFM660FHP GRIZZLY HUNER EDITION	2002	
	ACV-002M	YAMAHA	
		YFM400FAM/FAMC KODIAK 4WD	2000
		YFM400FAHM/FAHMC KODIAK 4WD	2000
YFM400AM/AMC KODIAK 2WD		2000	
YFM400FNNHM BIG BEAR		2000	
BUCKMASTER 4WD			
YFM400FNNM/FNNMC BIG BEAR 4WD		2000	
YFM400NM/NMC BIG BEAR 2WD		2000	
YFM400NN/NHN BIG BEAR 2WD		2001	
YFM400FNNN BIG BEAR 4WD		2001	
YFM400FNNHN BIG BEAR 4WD		2001	
REAL TREE X-TRA			
YFM400AN KODIAK 2WD		2001	
YFM400P BIG BEAR 2WD		2002	
YFM400HP BIG BEAR 2WD REAL TREE X-TRA		2002	
YFM400FP BIG BEAR 4X4		2002	
YFM400FHP BIG BEAR REAL TREE X-TRA		2002	

ACV-004MS	YAMAHA	
	YFM350S RAPTOR 350	04
	SUZUKI	
	LT-Z400K3/K4 QUADSPORT	03-04
	KAWASAKI	
	KSF400A1/A2 KFX400	03-04
ACV-005M	YAMAHA	
	YFM600FWAL/FWALC GRIZZLY	1999
	YFM600FWAM/FWAMC GRIZZLY	2000
	YFM600FWMH/FWHMC GRIZZLY REAL TREE	2000
	YFM600FHN GRIZZLY REAL TREE HUNTER	2001
	YFM600FN GRIZZLY	2001
ACV-201	YAMAHA	
	YFM250M/MC	2000
	YFM350ERT/ERU/ERW/ERA MOTO-4	87-90
	YFM350ERD/ERE/ERF/ERG MOTO-4	92-95
	YFM350FWT/FWU/FWW BIG BEAR	87-89
	YFM350FWA/FWB/FWD BIG BEAR	90-92
	YFM350FWE/FWF/FWG BIG BEAR	93-95
	YFM350FWH/FWJ BIG BEAR	96-97
	YFM350FWBJ BIG BEAR	1997
	YFM350UH/UJ/UK BIG BEAR 2WD	96-98
	YFM350FXG-FXM WOLVERINE	95-00
	YFM350XT/XU/XW/XA WARRIOR	87-90
	YFM350XB/XD/XE/XF/XG WARRIOR	91-95
	YFM350XH-XM WARRIOR	96-00
	YFP350U TERRAPRO	1988
	YFM400FWE/FWF/FWG KODIAK	93-95
	YFM400FWH/FWJ/FWK KODIAK	96-98

BRAKE CALIPER SEALING KIT

ACH-151 FRONT	HONDA	
	ATC200X	83-87
	ATC250R	82-84
	TRX250X FOURTRAX 250	87-88
	TRX250X FOURTRAX 250	91-92
ACH-152 REAR	TRX300EX FOURTRAX 300EX	93-00
	ATC200X	83-87
	ATC250R	82-84
	TRX250X FOURTRAX 250	87-88
	TRX250X FOURTRAX 250	91-92
ACH-153 FRONT	TRX300EX FOURTRAX 300EX	93-00
	ATC350X	85-86
	ATC250R	85-86
ACH-154 REAR	TRX250R FOURTRAX 250R	86-89
	ATC350X	85-86
	ATC250R	85-86
	TRX250R FOURTRAX 250R	86-89

ACY-251 FRONT	YAMAHA	
	YFM350FHL/FHLC BIG BEAR	1999
	YFM350FWBL/FWBLC BIG BEAR	1999
	YFM350FXG/FXH/FXJ/FXK	95-98
	YFM350FXL/FXLC-FXN/FXNC	99-01
	YFM350UL/ULC BIG BEAR	1999
	YFM350XW/XA/XB/XD/XE	89-93
	YFM350XF/XG/XH/XJ/XK/XKC	94-98
	YFM350XL/XLC-XN/XNC	99-01
	YZF350A-N BANSHEE	90-01
	YFM400AM/AMC/AN/ANC	00-01
	YFM400FWL/FWLC KODIAK	1999
	YFM400FAH KODIAK 4WD AUTO	00-01
	YFM400FA KODIAK 4WD AUTO	00-01
	YFM400FNN BIG BEAR 4WD	00-01
	YFM400FNNH BIG BEAR 4WD	00-01
	YFM400NM/NMC/NN/NNC	00-01
	YFM600FWAK/FWAL/FWALC	98-99
	YFM600FWA GRIZZLY	00-01
	YFM600HM/HMC/HN/HNC	00-01
	YFM660 RAPTOR	2001
ACY-252 (REAR)	YFM350FXG/FXH/FXJ/FXK	95-98
	YFM350FXL/FXLC-FXN/FXNC	99-01
	YFM350XT/XU WARRIOR	87-88
	YFM350XW/XA/XB/XD/XE	89-93
	YFM350XF/XG/XH/XJ/XK/XKC	94-98
	YFM350XL/XLC-XN/XNC	99-01
	YZF350T/U/W BANSHEE	87-89
	YZF350A-N BANSHEE	90-01

ACS-351 (FRONT)	SUZUKI	
	LT230EH/EJ-EN/EP	87-93
	LT230SF/SG/SH/SJ	85-88
	LT250RF/RG/RH/RJ/RK	85-89
	LT250RL/RM/RN QUADRACER	90-92
ACS-352 (REAR)	LT250SK/SL QUADRUNNER	89-90
	LT500RH/RJ/RK/RL QUADRACER	87-90
	LT230EH/EJ-EN/EP	87-93
	LT230SF/SG/SH/SJ	85-88
	LT250RF/RG/RH/RJ/RK	85-89
ACK-451 (FRONT)	LT250RL/RM/RN QUADRACER	90-92
	LT250SK/SL QUADRUNNER	89-90
	LT500RH/RJ/RK/RL QUADRACER	87-90
	KAWASAKI	
	KSF250A1-A16 MOJAVE 250	87-02
ACK-452 (REAR)	KXF250A1/A2 TECATE 4	87-88
	KEF300A1-A6 LAKOTA 300	95-00
	KEF300B1/B2 LAKOTA SPORT	01-02
	KLF300B1-B15 BAYOU	88-02
ACK-453 (FRONT)	KSF250A1-A16 MOJAVE 250	87-02
	KXF250A1/A2 TECATE 4	87-88
	KXT250B2 TECATE 3	1987
	KEF300A1-A6 LAKOTA 300	95-00
ACK-454 (FRONT)	KEF300B1/B2 LAKOTA SPORT	01-02
	KXT250A2 TECATE 3	1985
	KXT250B1 TECATE 3	1986
ACK-455 (FRONT)	KXT250B2 TECATE 3	1987
	KLF300C1-C14 BAYOU 4X4	89-02
ACK-455 (FRONT)	KLF400B1-B7 BAYOU 4X4	93-99
	KVF400A1-A3 PRAIRIE 400 4X4	97-99
	KVF400B1/B2 PRAIRIE 400	98-99
	KVF400C1-C4 PRAIRIE 400 4X4	99-02
	KVF400D1-D4 PRAIRIE 400	99-02



CLUTCH FRICTION DISC SET



DISC SET	MODEL	YEAR
	HONDA	
CDF-116	TRX500FM	05-08
CDF-126	TRX200	94-97
	TRX250	97-00
	TRX250EX	01-05
	TRX250TE	02-08
	TRX250TM	02-08
CDF-136P	TRX400EX	01-08
CDF-136X	TRX250EX	06-08
CDF-158	TRX300EX	93-06
CDF-188	TRX300	95-00
	TRX300	93-94
	TRX300FW	93-94
	TRX350FM	01
	TRX350FM	04-06
	TRX400FW	02
	TRX400FW	95-01
	TRX420FE	07-08
	TRX420FM	07-08
	TRX420TE	07-08
	TRX420TM	07-08
	TRX450ES	98-01
	TRX450FE	02-04
TRX450FM	02-04	
CDF-189	TRX350FE	05-06
	TRX350TE	01
	TRX350TE	04-06
CDF-190	TRX400ER	06-08
	TRX450R	04-08
	TRX700XX	08-09
CDF-191	TRX500FE	05-08
	YAMAHA	
CDF-224	YFM660R RAPTOR	01-05
CDF-237	YFM350FX WOLVERINE 4WD	00
	YFM350R RAPTOR	04-08
	YFM350X WARRIOR	00-01
	YFM35FX WOLVERINE	04
	YFM35R RAPTOR	07
	YFM35X WARRIOR	04
	YFM40 BIG BEAR 2WD	04
	YFM400 BIG BEAR 2WD	00-02
	YFM400F BIG BEAR 4WD	00-03
	YFM400FH BIG BEAR 4WD	01-02
	YFM400FH BIG BEAR BACK MASTER	00
	YFM400H BIG BEAR 2WD	02
	YFM400N BIG BEAR 2WD	03
	YFM40F BIG BEAR 4WD	06
	YFM40F BIG BEAR 4X4	04-05
	YFM40FH BIG BEAR 4WD	01
	YFZ350 BANSHEE	01-05

CDF-259	YFB250FW TIMBERWOLF	00
	YFM250X BEAR TRACKER	02-04
	YFM250X BEAR TRACKER 2WD	00-01
CDF-297	YFM25R RAPTOR	08
CDF-298	YFZ450	04-06
CDF-299	YFZ450	07
CDF-2A1	YFM700R RAPTOR	06
	YFM70R <700>	07-08
CDF-2A3	YFZ450R	09
	SUZUKI	
CDF-340	LT Z400 QUADSPORT	04
CDF-396	LT F 400 KINGQUAD FS 4X2	08
CDF-397	LT Z400 QUADSPORT	05
	LT Z400 QUADSPORT	06-07
	LT Z400 QUADSPORT	08
	LT Z400 QUADSPORT	09
CDF-398	LT R450 QUAD RACER	06-09



PLATE SET	MODEL	YEAR
	HONDA	
CPL-0033	TRX400ER	06-08
	TRX450R	04-08
CPL-0035	TRX200	94-97
	TRX250	97-00
CPL-0041	TRX300	95-00
	TRX300	93-94
	TRX300EX	93-06
	TRX300FW	93-94
	TRX350FM	01
	TRX350TE	01
	TRX400FW	95-01
CPL-0159	TRX450ES	98-01
	TRX350FE	05-06
	TRX350FM	04-06
	TRX350TE	04-06
CPL-0160	TRX400FW	02
	TRX420FE	07-08
	TRX420FM	07-08
	TRX420TE	07-08
	TRX420TM	07-08
	TRX450FE	02-04
	TRX450FM	02-04
	TRX500FE	05-08
	TRX500FM	05-08
	TRX400EX	01-08
	SUZUKI	
CPL-0065	LT Z400 QUADSPORT	04
CPL-0074	LT R450 QUAD RACER	06-09
CPL-0162	LT Z400 QUADSPORT	05
CPL-0163	LT F 400 KINGQUAD FS 4X2	08
CPL-0164	LT Z400 QUADSPORT	06-07
	LT Z400 QUADSPORT	08
	LT Z400 QUADSPORT	09

CARB HOLDER KITS



CHK-901	CARB HOLDER	1	CHY-903	CARB HOLDER	1
	O-RING	1		O-RING	1
	BOLTS	2		BOLT	2
	KAWASAKI			WASHER PLATE	2
	KLF300A1/A2 BAYOU	86-87		YAMAHA	
	KLF300B1-B9 BAYOU 300	88-96	YFM350FXH-FXM WOLVERINE	96-00	
	KLF300C1-C7 BAYOU 300 4X4	89-95	CHY-904	CARB HOLDER	1
CHY-901	CARB HOLDER	1	O-RING	1	
	O-RING	1	BOLT	2	
	NUT	2	FLANGE NUT	2	
	WASHER	4	YAMAHA		
	SOCKET SCREW	2	YTM225DRN/DRS TRI-MOTO	85-86	
	O-RING	1	YTM225DXK/DXL/DXN TRI-MOTO	83-85	
	YAMAHA		YFM225S/T/U MOTO-4	86-88	
	YFM350ERT MOTO-4	1987	YFB250E/F/G TIMBERWOLF	93-95	
	YFM350ERTU/ERW/ERA MOTO-4	88-90	YFB250EWF-FWM TIMBERWOLF	94-00	
	YFM350ERD-ERG MOTO-4	92-95	YFM250W/A/B MOTO-4	89-91	
	YFM350FWT BIG BEAR	1987	CHY-905	CARB HOLDER	1
	YFM350FWU-FEW BIG BEAR	88-93	BOLT	2	
	YFM350FWF-FWH BIG BEAR	94-97	WASHER	2	
YFM400FWE-FWK KODIAK	93-98	YAMAHA			
CHY-902	CARB HOLDER	1	YFS200 BLASTER	88-05	
O-RING	1	CHY-909	YFZ350 BANSHEE	87-03	
BOLTS	2	YFZ350LES BANSHEE	04		
NUTS	2	YFZ350SET/SEV BANSHEE	05-06		
WASHER PLATE	4	YFZ350T/V BANSHEE	05-06		
O-RING	1	YFZ350RB BANSHEE	03		
YAMAHA		CHY-910	YFM660RLER/RLES RAPTOR	03-04	
YFM350FXG WOLVERINE	1995	YFM660RP RAPTOR	02		
YFM350XT WARRIOR	1987	YFM660RPB RAPTOR	02		
YFM350XU-XH WARRIOR	88-96	YFM660RN/RR/RS/RT	01-05		
YFM350XJ-XM WARRIOR	97-00				

CAM SHAFT TIMING CHAINS for ATV



STOCK NO	MODEL APPLICATION		STOCK NO	MODEL APPLICATION	
	HONDA				
CMM-E52	TRX250 RECON	97-01	CMM-E56	TRX400FW	95-02
CMM-B110	TRX300 FOURTRAX	88-00		TRX450ES	98-01
	TRX300EX FOURTRAX	93-00		TRX450FE	02-04
	TRX300EX SPORTRAX	01-08		TRX450FM	02-04
	TRX300FW FOURTRAX 4WD	88-00		TRX450S	98-01
CMM-J52	TRX250EX SPORTRAX	01-08	CMM-BB112	TRX400EX	00-08
	TRX250TE RECON	02-07	CMM-J60	TRX420FE	07-09
	TRX250TE FOURTRAX	06		TRX420TM	07-09
	TRX250TM RECON	02-05		TRX420FM	07-09
	TRX250TM FOURTRAX	06		TRX420FPA	09
	TRX350FE FOURTRAX	00-06		TRX420FPE	09
	TRX350FM FOURTRAX	00-06		TRX420FPM	09
	TRX350TE FOURTRAX	00-06		TRX420TE	07-09
	TRX350TM FOURTRAX	00-06	CMM-E112	TRX450ER	06-08
	TRX400FA	04-07		TRX450R	06-08
			CMM-E114	TRX450R	04-05

STOCK NO	MODEL APPLICATION	
CMM-J104	TRX-500FA	01-09
	TRX500RGA	04-08
	TRX500FPA	09
CMM-J56	TRX500FE	05-08
	TRX500FM	05-08
	TRX500FPE	07-08
CMM-J110	TRX650FA	03-05
	TRX680FA	06-09
	TRX680FGA	06-09

YAMAHA

CMM-U92	YFA1 BREEZE	91-04
	YFM125GH GRIZZLY	05-08
	YFM125G GRIZZLY	05-08
CMM-X104	YFB250(D)	92
	YFB250(E) TIMBERWOLF	93
	YFB250(F-H) TIMBERWOLF 2WD	94-96
	YFB250U(H-K) TIMBERWOLF 2WD	96-98
	YFB250(E)-MNH	93
	YFB250(H)-MNH	96
	YFB250FW(F-J)-MNH	94-97
	YFB-250U(H-J)-MNH	96-97
	YFB250FW(F-M) TIMBERWOLF 4WD	94-00
	YFM200(N) MOTO-4	85
	YFM200DX(S-T) MOTO-4	86-87
	YFM200DX(U-W) TOMO-4 SHAFT	88-89
	YFM225(S-T) MOTO-4	86-87
	YFM225(U) MOTO-4 SHAFT	88
	YFM250(W-B) MOTO-4	89-91
	YFM250B(T) BRUIN 250	05
	YFM250U(K)	98
	YFM250XH(N-P) BEAR	01-02
	YFM250X(L-S) BEAR TRACKER	99-04
	YFM250B(W-X) BIG BEAR 250	07-08
	YFM250(V) BRUIN 250 2WD	06
	YFM250(S) BEAR TRACKER	04
	YTM200(K-N)	83-85
	YTM200E(K-L)	83-84
	YTM200ER(N) TRI-MOTO	85
	YTM225DR(N-S) TRI-MOTO	85-86
	YTM225DX(L-N) TRIMOTO	84-85
CMM-G90	YFM350FW(D)-MNH	92
	YFM350ER(T-U) MOTO-4	87-88
	YFM350ER(A) MOTO-4	90
	YFM350ER(D-G) MOTO-4	92-95
	YFM350FH(L) BIG BEAR 4WD HUNTER	99
CMM-G90	YFM350FW(T-W) BIG BEAR 4WD	87-89
	YFM350FW(A-H) BIG BEAR 4WD	90-96
	YFM350FWS(J) BIG BEAR 4WD	97
	YFM350FW(F-J)-MNH	94-97
	YFM350FWB(K-M) BIG BEAR 4WD	98-00
	YFM350FX(P) WOLVERINE	02
	YFM350FX(R) WOLVERINE 4X4	03
	YFM350FX(G-L) WOLVERINE 4WD	95-99
	YFM350FX(G-J)-MNH	95-97
	YFM350R(S) RAPTOR 350	04
	YFM350RSE(T-V) RAPTOR 350	05-06
	YFM350R(T-V) RAPTOR 350	05-06
	YFM350U(H-L) BIG BEAR 2X4	96-99
	YFM350U(H-J) -MNH BIG BEAR 2X4	96-97
	YFM350X(U-R) WARRIOR	88-03
	YFM350X(B-G)-MNH	91-95
	YFM350X(H) MNH WARRIOR 4WD	96
	YFM350X(J) MNH WARRIOR	97
	YFM350X(F) WARRIOR	94
	YFM35FX(G-J)	96-97
	YFM35FX(G-J) -MNH	96-97
	YFM35FX(N) WOLVERINE	01
	YFM35FX(S-T) WOLVERINE	04-05
	YFM35RSE2(W) RAPTOR 350	07
	YFM35R(W-X) RAPTOR 350	07-08
	YFM350X(S) WARRIOR	04
	YFP350(U) TERRA PRO	88
CMM-G92	YFM400FH(M-N)	00-01
	YFM400FH(P) BIG BEAR RWD REALTREE	02
	YFM400F(M-R) BIG BEAR 4WD	00-03
	YFM400FWB(L) KODIAK 4WD	99
	YFM400FW(E-K) KODIAK 4WD	93-98
	YFM400(M-P) BIG BEAR 2WD	00-02
	YFM400H(N-P) BIG BEAR 2WD	01-02
	YFM400N(R) BIG BEAR 400 2WD	03
	YFM40BE(W) BIG BEAR 400 IRS EXPLO	07
	YFM40FBH(W-X) BIG BEAR HUNTER IRS	07-08
	YFM40FB(W) BIG BEAR 400 IRS	07
	YFM40FB(X) BIG BEAR 400 4WD	08
	YFM40FH(N) BIG BEAR 4WD REALTREE	01
	YFM40F(N) BIG BEAR 4WD	01
	YFM40F(S-T) BIG BEAR 400 4X4	04-05
	YFM400F(V) BIG BEAR 400 4WD	06
	YFM40(S) BIG BEAR 400 2WD	04

STOCK NO	MODEL APPLICATION	
CMM-A126	YFM600FH(M-N) GRIZZLY REALTREE	00-01
	YFM600F(M-N) GRIZZLY	00-01
	YFM600FWA(K-L) GRIZZLY	98-99
	YFM660R(N) RAPTOR	01
	YFM660RLE(S) RAPTOR	04
	YFM660R(P) RAPTOR	02
	YFM660R(S-T) RAPTOR 660	04-05
	YFM660R(P)B RAPTOR LIMITED EDITION	02
	YFM66RSE(T) RAPTOR SE	05
	CMM-J116	YFM400A(R) KODIAK 4000
YFM400FAH(P)		02
YFM400FAH(R) KODIAK 400 4X4 CAMO NARDWOOD		03
YFM4400FA(P) KODIAK 4WD		02
YFM400FAR		03
YFM400FHA(P) KODIAK 4WD HUNTER		02
YFM450FAH(R) KODIAK 450 REAL TREE		03
YFM450FAR KODIAK 450 4WD		03
YFM45FAH(S) KODIAK 450 AUTO 4X4 HARDWOOD		04
YFM45FA(S) KODIAK 450 AUT5O 4X4		04
YFM45FA(T) KODIAK450 4WD		05
YFM4A(S) KODIAK400 2WD		04
YFM4FAH(S) KODIAK 400 AUTO 4X4		04
YFM4FA(S) KODIAK 400 4X4		04
YFM4FA(T) KODIAK 400 4WD		05
YFM45FAH(T-V) KODIAK 450 4WD HUNTER		05-06
YFM45FASE(T-V)		05-06
YFM45FA(V) KODIAK 450 4WD		06
YFM45FGH(W-X) GRIZZLY 450 HUNTER		07-08
YFM45FGOH(W) GRIZZLY 450 OUTDOORSMAN		07
YFM45FGSE(W) GRIZZLY 450 SPECIAL SLIVER	07	
YFM45FG(W) GRIZZLY 450	07	
YF45FG(X) GRIZZLY 450 HUNTER	08	
CMM-J116	YFM45FSE(T) KODIAK 450 4WD BLACK CARBON	05
	YFM45FXSE(W)	07
	YFM45FXSP(X) WOLVERINE 450 4X4 SPORT SE	08
	YFM45FX(V-W) WOLVERINE 450 4X4 SPORT	06-07
	YFM45FX(X) WOLVERINE 450 4WD	08
	YFM4FAH(T-V) KODIAK 400 4WD HUNTER	05-06
	YFM4FA(V) KODIAK 400 RWD	06
	YFM4FGH(W) GRIZZLY 400 UNTER	07
	YFM4FGH(X) GRIZZLY 400 4WD HUNTER	08
	YFM4FG(W-X) GRIZZLY 400 4WD	07-08
	YXR45FAH(V) VXR450 REALTREE HD CAMO SIDE	06
	YXR45FAVG RHINO 450 4WD SIDE X SIDE	06
	YXR45FH(W-X) RHINO 450 HUNTER SIDE X SIDE	07-08
YXR45FSE(W) RHIN 450 SIDE X SIDE	07	
YXR45FSP(X) RHINO 450 SIDE X SIDE	08	
YXR45F(W) RHINO 450 SIDE BY SIDE	07	
YXR45FXGR RHINO 450 SIDE X SIDE	08	
YXR45FXR RHINO 450 SIDE BY SIDE	08	
CMM-J126	YFM660FHRWL GRIZZLY WETLANDS HUNTER EDI	03
	YFM660FHRH GRIZZLY REAL TREE HARDWOOD H	03
	YFM660FR GRIZZLY 660	03
	YFM660 FH(R)WL GRIZZLY WETLAND HUNTER	03
	YFM660FH(R)G GRIZZLY REAR HARDWOOD	03
	YFM660FH(R)HD	03
	YFM660FH(R)WL	03
	YFM660FH(S) GRIZZLY 660 HARDWOODS HUNTER	04
	YFM660FH(S)WL GRIZZLY 660 AUTO 4X4 WETLAN	04
	YFM660FLE(S) GRIZZLY 660 AUTO 4X4 LIMOTED	04
	YFM660F(P)S GRIZZLY 660 SILVER	02
	YFM660F(R) GRIZZLY 660	03
	YFM660FRGY GRIZZLY 660 4X4 METALIC TITANIUM	03
	YFM660F(S) GRIZZLY 660	04
	YFM66FAH(T-V) GRIZZLY 660 HUNTER	05-06
	YFM66FAHW(T) GRIZZLY 660 HUNTER WETLAND	05
	YFM66FASE(T) GRIZZLY 660 SE	05
YFM66FA(T-V) GRIZZLY 660	05-06	
YFM66FGH(X) GRIZZLY 660 HUNTER	08	
YFM66FG(W) grizzly 660	07	
YFM66FG(X) GRIZZLY 660	08	
CMM-FF126	YFM700RSP(V) RAPTOR 700 50TH ANNIVERSARY	06
	YFM700R(V) RAPTOR 700	06
	YFM700FH(X) RHINO 700 FI HUNTER	08
	YFM70RSE2(W) RRAPTOR 700 SP ED.	07
	YFM70RSE(W) RAPTOR 700 SP ED.	07
	YFM70RSP2(X) RAPTOR 700 SP ED.	08
	YFM70RSPX RAPTOR 700 SP ED	08
	YFM70R(W-X) RAPTOR 700	07-08
	YFM70RYR(W) RAPTOR 700 GYTR ED.	07
	YFM7FGH(X) GRIZZLY 700 HUNER	08
	YFM7FGPDU(W-X) GRIZZLY 700 DUCKS UNLIMITED	07-08
	YFM7FGPH(W-X) GRIZZLY 700 HUNTER	07-08
	YFM7FGPOH(W) GRIZZLY 700 OUTDOORSMAN	07
	YFM7FGPSE(W) GRIZZLY 700 SP ED.SILVER	07
	YFM7FGPSP(X) GRIZZLY 700 SP.ED	08
	YFM7FGP(W-X) GRIZZLY 700	07-08
	YFM7FG(X) GRIZZLY 700	08
YXR7FRDUX RHINO 700 FI DUCK UNLIMITED SIDE	08	

STOCK NO	MODEL APPLICATION		
CMM-FF126	YXR70FSEP(X) RHINO 700 FI SP.ED.	08	
	YXR70FSP2X RHINO 700 FI SP.ED.II	08	
	YXR70FSPX RHINO 700 FI SPORT5 ED.	08	
	YXR70FXGR RHINO 700 FI	08	
	YXR70FXR RHINO 700 FI	08	
CMM-Y110	YFM35A(S) BRUIN 350 AUTO 2WD	04	
	YFM35BA(T-V) BRUIN 2WD	05-06	
	YFM35FAH(S-V) BRUIN 350 AUTO 4X4	04-06	
	YFM35FA(S-V) BRUIN 350 AUTO 4X4	04-06	
	YFM35FGH(X) GRIZZLY 350 4WD HUNT	08	
	YFM35FGH(W-X) GRIZZLY 350 IRS HUN	07-08	
	YFM35FGI(W-X) GRIZZLY 350 IRS	07-08	
	YFM35FG(W-X) GRIZZLY 350 4WD	07-08	
	YFM35G(W) GRIZZLY 350 2WD	07-08	
	YFM35X(V-X) WOLVERINE 350 2WD	06-08	
CMM-FF118	YFZ450(S-X)	04-08	
	YFZ450BB(V-W) YFZ450 BILL BALANCE	06-07	
	YFZ450LE(S) YFZ450 LIMITED ED.	04	
	YFZ450(S) YFZ450	04	
	YFZ450SE(T-W) YFZ450 SP.ED.	05-06	
	YFZ450SP2X	08	
	YFZ450SP(V/X) YFZ450 SP.ED	06/08	
	YFZ45SE2(W)	07	
	YFZ45SE(W) YFZ450	07	
	YFZ450F(R-X) YFZ450F	03-08	
	YFZ450FSP(V) YFZ450F 50TH ANV.	06	
	CMM-U82	YFM80WS/RT/RV RAPTOR 80	04-06
		YFM100(T-B) CHAMP	87-91
YFM50R(T-X) RAPTOR 50		05-08	
YFM50(S) RAPTOR 50		04	
YFM80(S-N) BADGER		86-01	
YFM80GH(V-X) GRIZZLY 80 HUNTER		06-08	
YFM80G(T-X) GRIZZLY 80		05-08	
YFM80R(T-X)		05-08	
YFM80W(P-S) RAPTOR 80		02-04	
SUZUKI			
CMM-X98	LT-F160	93-01	
	LT-F160T	91-96	
	LT160	03-04	
	LT160E	89-92	
CMM-X102	LT-F230	86-87	
	LT230E	87-93	
	LT230S	85-88	
	LT230	86-87	
CMM-X104	LT-4WD	93-95	
	LT-F250	93-95	
	LT-F250T	88-96	
	LT250S	89-90	
CMM-T98	ALT125	83-86	
	ALT185	85	
	ALT50	83-84	
	LT125	83-87	
LT185	84-85		
CMM-A118	LT300E	87-89	
CMM-BB108	LT-F4WDX	93-95	
	LT-F4WDXS	91-95	
	LT-4WDXW	96-98	
	LT-A400	02-09	
	LT-A400C	03-05	
	LT-A400F	02-09	
	LT-F300F	99-02	
	LT-F400	02-08	
	LT-F400F	02-09	
	LT-F4WDX	95-97	
	LT-F4WDXS	91-95	
	CMM-E124	LT-A450X	07-09
		LT-A450XZ	08-09
LT-A500F		00-07	
LT-A500FB		04	
LT-A500FC		98-07	

STOCK NO	MODEL APPLICATION		
CMM-BB128	LT-Z400	03-09	
	LT-Z400Z	03-09	
CMM-B106	LT-F250	07-09	
	LT-Z250	04-09	
KAWASAKI			
CMM-B106	KLF220 A5-A15 BAYOU 220	92-02	
	KLF250 A1-A3	03-05	
	KLF250 A6-A9	06-09	
CMM-B158	KSF250 A1	87	
	KSF250 A3-A7	89-93	
	KSF250 A10-A18	04	
	KSF250A8-A9	94-95	
CMM-W90	KEF300 A1-A6 LAKOTA 300	95-00	
	KEF300 B1-B3 LAKOTA SPORT	01-03	
	KLF300 B10-B17 BAYOU 300	97-04	
	KLF300 B5-B9 BAYOU 300	92-96	
	KLF300 C1 BAYOU 300 4X4	89	
	KLF300 C10-C16 BAYOU 300	98-04	
	KLF300 C2-C9 BAYOU 300	90-97	
	KVF300 A1-A4 PRAIRIE 300 4X4	99-02	
	KVF300 B1-B4 PRAIRIE 300	99-02	
	KLF300 A1-A2 BAYOU 300	86-87	
	KLT200 B1	83	
	KLT200 A1-A4	81-83	
	KLT250 A1-A2	82-83	
	KLT250 C1-C3 PRAIRIE	83-85	
	KLT200 A1-A4 KLT200	81-83	
	KLT200 C1-C2 KLT200	83-84	
	KLT200 C1-C3 PRAIRIE	83-85	
	KLF300 B1-B4 BAYOU 300	89-91	
	CMM-B118	KVF360(A1-A7F) PRAIRIE 360 4X4	03-07
		KVF360(B1-B7F) PRAIRIE 360	03-07
KLF400 B1-B7 BAYOU 400 4X4		93-99	
KVF360 A1-A3 PRAIRIE 360		03-05	
KVF360 B1-B3 PRAIRIE 360		03-05	
KVF360 C1-C3 PRAIRIE 360 4X4		03-05	
KVF360A6F-A9F PRAIRIE 360 4X4		06-09	
KVF360B6F-B9F PRAIRIE 360		06-09	
KVF360C6F-C9F PRAIRIE 360 4X4		06-09	
KVF400 A1-A2 PRAIRIE 400 4X4		97-98	
CMM-J92	KVF400 B1 PRAIRIE 400	98	
	KVF400 C1-C4 PRAIRIE 400 4X4	99-02	
	KVF400 D1-D4 PRAIRIE 400	99-02	
	KVF650D1-D7F BRUTE FORCE 650 4X4	05-07	
	KVF650 E1-E7F BRUTE FORCE 4X4	05-07	
	KVF650G6F/G7F 4X4 REALTREE	06-07	
	KSV700 A1-A2 KFX700	04-05	
	KSV700 B2-B7F KFX700	05-07	
	KSV750 B1-B7F BRUTE FORCE	05-07	
	KSV750 BA-B7F BRUTE FORCE 4X4	05-07	
CMM-E96 (SECONDARY)	KVF650D1-D7F BRUTE FORCE 4X4	05-07	
	KVF650E1-E7F BRUTE FORCE 4X4	05-07	
	REALTREE HARDWOODS GREEN		
	KVF650G6F/G7F 4X4 REALTREE	06-07	
	HARDWOODS GREEN		
CMM-J92	KSV700A1-A2 KFX700	04-05	
	KSV700B2-B7F KFX700	05-07	
	KVF750B1-B7F BRUTE FORCE 4X4	05-07	
	REALTREE HARDWOODS GREEN		
	KVF650A1-A2 PRAIRIE 650 4X4	02-03	
CMM-E46 (SECONDARY)	KVF650B2 PRAIRIE 650 4X4	03	
	ADVANTAGE CLASSIC		
	KVF700A1-A6F PRAIRIE 700 4X4	04-06	
	KVF700B1-B2 PRAIRIE 700 4X4	04-05	
	HARDWOODS GREEN		
CMM-B102	KLT110A1-A3 3-WHEEL	84-86	
	KLT160A1 3-WHEEL	85	
	KLT185A1-A2 3-WHEEL	86-87	

MUFFLER CONNECTING GASKETS



HONDA		
MCG-102C	TRX350(H-N)	87-92
	TRX350D(H-K)	87-89
MCG-116C	ATC250ES	87
	TRX250	87
MCG-119C	TRX400EX(X/Y/1/2)	99-02
	TRX450R(4/5)	04-05
KAWASAKI		
MCG-401C	KEF300A1-A6 LAKOTA	95-00
	KEF300B1-B3 LAKOTA	01-03
MCG-403C	KSF250A18 KFX250 MOJAVE	04

EXHAUST PIPE GASKETS

HONDA		
EPG-102C	TRX350	86-87
	TRX350D(H/J/K)	87-89
EPG-103C	ATC250ES(H-J)	87-88
	TRX250H	87
	TRX300FW(J/K)	88-89
	TRX300J/K	88-89
EPG-108C	TRX650FA(3-6)	03-06
EPG-109C	TRX125H/J	87-88
	TRX200D	94
	TRX200D(M-V)	91-97
	TRX200L/M	90-01
	TRX200SXH	87
	TRX200SXJ	87
	TRX250EX(1-6)	01-06
	TRX250TE(2-6)	02-06
	TRX250TM(2-6)	02-06
	TRX350(H-N)	87-92
	TRX350D(H/J/K)	87-89
	TRX350P	93
	TRX400EX(X-5)	99-05
EPG-131C	TRX90(P-6)	93-06
EPG-132C	TRX450ER6	06
	TRX450R(4-6)	04-06



YAMAHA		
EPG-201C	YFM250 BRUIN	05
EPG-208C	YFM660 GRIZZLY	02-06
	YFM660 RAPTOR	01-05
	YFM700 RAPTOR	06
	YFM700RSPV	06
EPG-220C	YFM350 BRUIN	04-06
	YFM350 RAPTOR	04-06
	YFM400 KODIAK	93-06
	YFM450 KODIAK	03-06
	YFM450 WOLVERINE	06
SUZUKI		
EPG-309C	LTF400 EIGER	02-05
	LTF400F EIGER	06
	LTA500F VINSON	06
	LTF500 VINSON	02-05
EPG-320C	LTR450 QUADRACER	06
EGP-321C	LT-2400 QUARDSPORT	03-06
	LTA700X KINGQUAD	05-06

FUEL PETCOCK REPAIR KIT, ATV



FCK-7	KAWASAKI	
	KLT110A1/A2/A3	84-86
	KLT160A1	1985
	KLT185A1/A2	86-87
	KLF300A1-A2 BAYOU	86-87
FCK-15	YAMAHA	
	YT125G/H/J/K/L/N TRI-MOTO	80-85
FCK-19	YAMAHA	
	YT175J/K TRIM-MOTO	82-83
FCK-19	YAMAHA	
	YFP350U TERRAPRO	1988
	KAWASAKI	
	KXF250A1/A2	87-88
	KXT250A1/A2 TECATE 3	84-85
	KXT250B1/B2 TECATE 3	86-87
	KEF300A1-A6 LAKOTA 300	95-00
	KLF300C7-C12 BAYOU 4X4	95-00
	KLF400B1-B7 BAYOU 4X4	93-99
	FCK-22	YAMAHA
YF60S MOTO-4		1985
YT60L/N TRI-ZINGER		84-85
YFM80N/S/T/U MOTO-4		85-88

FCK-22	YFM80D/E/F/G/H MOTO-4	92-96
	YFM80J1/K1 BADGER	97-98
	YFM100T/U/W/A/B CHAMP	87-91
	YFA1W/A/B BREEZE	89-91
	YFA1D/E/F/G/H/J/K BREEZE	92-98
	YFM200N MOTO-4	1985
	YFM200DXS/DXT/DXU MOTO-4	86-88
	YFM200DXW MOTO-4	1989
	YTM200K/L/N TRI-MOTO	83-85
	YTM200EK/EL TRI-MOTO	83-84
	YTM200ERN TRI-MOTO	1985
	YFS200U/W/A/B/D BLASTER	88-92
	YFS200E-M BLASTER	93-00
	YFM225S/T/U TRI-MOTO	86-88
	YTM225DXK/DXL/DXN TRI-MOTO	83-85
	YTM225DRN/DRS TRI-MOTO	85-86
	YFB250D/E/F/G/H TIMBERWOLF	92-96
	YFB250UH/UJ/UK TIMBERWOLF	96-98
	YFB250FWF/FWG/FWH TIMBERWOLF	94-96
	YFB250FWJ/FWK TIMBERWOLF	97-98
	YFM250W/A/B MOTO-4	89-91
	YFM350ERT/ERU/ERW/ERA MOTO-4	87-90
	YFM350ERD/ERE/ERF/ERG MOTO-4	92-95
	YFM350FWT-FWA BIG BEAR	87-90
	YFM350FWB-FWF BIG BEAR	91-94
	YFM350FWG/FWH/FWJ BIG BEAR	95-97
	YFM350FWBJ-FWBL BIG BEAR 4X4	97-98
	YFM350FXG-FXK WOLVERINE	95-98
	YFM350UH/UJ/UK BIG BEAR 2WD	96-98
	YFM350XT-XD WARRIOR	87-92
	YFM350XE-KC WARRIOR	93-98
	YFU1W PRO-HAULER	1989
	YFU1TW PRO-HAULER	1989
	YZF350U-G BANSHEE	88-95
	YZF350H-L BANSHEE	96-99
	YFM400FWE/FWF/FWG KODIAK	93-95
	YFM400FWH/FWJ/FWK KODIAK	96-98
YFM600FWAK/FWAL GRIZZLY	98-99	

FORK SEAL KIT, ATV



FSM-001	KAWASAKI	
	KXT250A1 TECATE	1984
	KXT250A2 TECATE	1984
FSM-003T	HONDA	
	ATC250R	83-84
	ATC250X	85-86
	YAMAHA	
YTZ250N	1985	
FSM-004	HONDA	
	ATC200X	84-87
	TLR200	86-87
	ATC250ES	85-87
	ATC250SX	85-87
	TR200	86-87

FSM-016	HONDA	
	ATC185S	1983
	ATC200	1983
	ATC200M	84-85
	ATC200S	84-86
	ATC250R	81-82
	YAMAHA	
	YT175J/K TRI-MOTO	82-83
	YTM200ERN	85
	YTM200EK/EL/ERN	83-85
	YTM200K/L/N	83-85
	YTM220DXK-DXN	83-84
	YTM225DXK-DXN	83-84
	YTM225DRN	85
	KAWASAKI	
KLT110A2/A3	85-86	
KLT160A1	1985	
KLT185A1/A2	86-87	
FSM-037	HONDA	
	ATC250R	85-86
	YAMAHA	
YTZ250S	1986	
FSM-041	KAWASAKI	
	KXT250B1/B2 TECATE	86-87

MASTER CYLINDER REPAIR KITS



MSB-101 (FRONT)	HONDA	
	TRX200	90-91
	TRX200D	91-97
	TRX250EX	01-06
	TRX200SX	87
	TRX250TE	02-06
	TRX250TM	02-06
	TRX300(J-T)	88-96
	TRX300(X-Y)	99-00
	TRX300EX	05-06
	TRX350FE	00-03
	TRX350FM	00-03
	TRX350H	87
	TRX350TE	00-03
	TRX350TM	00-03
	TRX400EX	99-06
	MSB-104 (FRONT)	HONDA
TRX300FW(J-T)		88-96
TRX300FW(X-Y)		99-00
TRX300Y		00
TRX400FW(S-T)		95-96
TRX400FW(X-Y)		99-00
TRX450ES		98-01
TRX450FE		02-04
TRX450FM		02-04
TRX450S		98-01
TRX500FA	01-04	
MSB-113 (FRONT)	HONDA	
	TRX250R	87-89
	TRX300EX	93-00
MSB-201 (FRONT)	YAMAHA	
	YFM350FWBL BIG BEAR 4WD	99
	YFM400FWBL KODIAK 4WD	99
	YFM600FWAL GRIZZLY	99
	YFM600FHM GRIZZLE	00
	REAL TREE	
	YFM600FM GRIZZLY	00
	YFM600FN GRIZZLY	01
	YFM600FWAK GRIZZLY	98
MSB-204 (FRONT)	YAMAHA	
	YTZ250N TRI-Z	85
MSB-209 (FRONT)	YAMAHA	
	YTZ250S TRI-Z	86
MSB-219 (FRONT)	YAMAHA	
	YFM350FX(G-N) WOLVERINE 4WD	95-01
	YFM350X(G-N) WARRIOR	95-01
	YFM350FW(G-BK) BIG BEAR 4WD	95-98
	YFZ350(G-K) BANSHEE	95-98
YFM400FW(G-K) KODIAK 4WD	95-98	
MSB-303 (FRONT)	SUZUKI	
	LT250EF(F/G)	85-86
	LT-F250F(X-K2) QUAD RUNNER	99-02
	LT-F250(J-K6) 2WD	88-06
	LTF300F KING QUAD	99-02
	LTF4WDX KING QUAD	91-98
	LT4WD QUAD RUNNER	88-98
	LTA500F AUTO 4WD	00
	LTA500F AUTO QUAD MASTER	01
	LTA500F AUTO VINSON 4WD	02-06
	LTF500F QUAD MASTER	98-01
	LTF500F 4WD VINSON	02-06
	LTF500F 4WD VINSON CAMO	06
	LTA700X KING QUAD	06

MSB-304 (FRONT)	SUZUKI	
	LT250R QUAD RACER	85-90
	LT300E 2WD	87-89
	LT500R QUADZILLA	88-90
	LT230E QUAD SPORT	87-90
	LT230S QUAD SPORT	85-88
	LT230G	85-86
	LTF230	86-87
	LT250S QUAD SPORT	89-90
	LT4WD	87
LT500R QUADZILLA	87-90	
MSB-307 (FRONT)	SUZUKI	
	LT230E QUAD SPORT	91-93
	LT250R QUAD RACER	91-92
	LT-Z250 QUAD SPORT	04-06
MSB-401 (FRONT)	KAWASAKI	
	KVF750(B1/AF6/BF6/AF7/BF7)	05-07
MSB-402 (FRONT)	KAWASAKI	
	KSF250A1 MOJAVE	87
	KXF250A1/A2 TECATE 4	87-88
MSB-403 FRONT	KAWASAKI	
	KXT250B2 TECATE 3	87
	KSF250A2-A17 MOJAVE	88-03
	KEF300A1-A6 LAKOTA 300	95-00
	KLF300A1-B17 BAYOU	86-04
	KLF300C1-C16 BAYOU 4X4	89-04
	KVF300B1-B4 PRAIRIE 300	99-02
	KVF300A1-A4 PRAIRIE 300 4X4	99-02
	KVF360B1-B7F PRAIRIE	03-07
	KVF360A1-A7F PRAIRIE 4X4	03-07
	KVF360C2-C7F PRAIRIE 4X4 HARDWOODS	04-07
	KLF400B1-B7 BAYOU	93-99
	KVF400A1-A2 PRAIRIE 4X4	97-98
	KVF400C1-C4 PRAIRIE 4X4	99-02
	KVF650A1-A2 PRAIRIE	02-03
	KVF650B1 PRAIRIE	02
	KVF700A1-A6F PRAIRIE	04-06
KVF650D1-D7F BRUTE FORCE 4X4	05-07	
MSR-103 (REAR)	HONDA	
	TRX300EX	93-06
	TRX450ER	06
MSR-203 (REAR)	YAMAHA	
	YTZ250N TRI-Z	85
	YTZ250S TRI-Z	86
	YFZ350(T-N)	87-01
YFM350X(T-W)	87-89	
MSR-302 (REAR)	SUZUKI	
	LT230E (ELECTRICAL START)	87-88
	LT230S QUAD SPORT	85-88
	LT250R QUAD RACER	85-92
	LT250S QUAD SPORT	89-90
LT500R QUADZILLA	87-90	
MSR-303 (REAR)	SUZUKI	
	LTR450 QUADRACER	06
	LTF500F VINSON MANUAL 4WD	05-06
	LTF500F 4X4 CAMO	06
	LTF500F VINSON STD 4WD	03-04
	LTA500F VINSON AUTO 4WD	02
	LT-Z400 QUAD SPORT	04-07
LT230E (ELECTRICAL START)	89-93	
MSR-404 (REAR)	KAWASAKI	
	KSF250A2-A17 MOJAVE	88-03
	KEF300A1-A6 LAKOTA 300	95-00

PULSER COIL



PCL-901	ATC125M	86-87	
	TRX125 FOURTRAX 125	87-88	
	TRX200(L-M)	90-91	
	TRX200D(M-V)	91-97	
	ATC250ES	85-87	
	ATC250SX	85-87	
	TRX250 FOURTRAX 250	85-87	
	TRX250 RECON 250	97-01	
	TRX250EX SPORTRAX	01-06	
	TRX250TE FOURTRAX RECON ES	02-06	
	TRX250TM FOURTRAX RECON	02-06	
	TRX250X	87-88	
	TRX250X FOURTRAX	91-92	
	TRX300 FOURTRAX 300	88-02	
	PCL-901	TRX300EX FOURTRAX 300EX	93-06
		TRX300EX SPORTRAX 300EX	01-06
		TRX300FW FOURTRAX 300 4X4	88-00
		TRX350	89-93
		TRX350D FOURTRAX FOREMAN 4X4	88-89
		TRX350FE FOURTRAX RANCHER 4X4 ES	00-06
		TRX350FM FOURTRAX RANCHER 4X4	00-06
TRX350TE FOURTRAX RANCHER ES		00-06	
TRX350TM FOURTRAX RANCHER		00-06	
FL400R PILOT		89-90	
TRX400FW FOURTRAX FOREMAN		95-03	
TRX400FM FOURTRAX FOREMAN		2002	
TRX450ES FOURTRAX FOREMAN ES		98-01	
TRX450FE FOURTRAX FOREMAN ES		02-04	
TRX450S FOURTRAX FOREMAN S		98-01	
TRX450FM FOURTRAX FOREMAN S		02-04	
TRX500FA FOURTRAX RUBICON		01-06	
TRX500FGA FOURTRAX RUBICON		01-04	
TRX650FA FOURTRAX RINCON		03-05	
TRX650FGA FOURTRAX RINCON		2004	

VOLTAGE REGULATOR RECTIFIERS



HONDA

RGU-109	TRX300FW FOURTRAX 300	88-92
	TRX300FW FOURTRAX 300 4WD	1988
	TRX300FW FOURTRAX 300 4WD	90-92
RGU-119	TRX300	93-00
	TRX300FW	93-96
RGU-120	TRX300EX SPORTRAX	93-04
RGU-141	TRX400FW	95-00
	TRX450S	98-00
	TRX450ES	98-00

YAMAHA

RGU-202	TW200U/UC/W/WC/A/AC/B/BC	88-91
	TW200D/DC/E/EC/F/FC/G/GC	92-95
	TW200H/HC/J/JC	96-97
	TW200EK/EKC	1998
RGU-205	YFM225S/T/U	86-88
	YFM250W/A/B	89-91
	YFU1W	1989
	YFU1TW	1989
	YFM350ERA	1990
	YFM350ERD/ERE/ERF	92-94
	YFM350FWT/FWU/FWW/FWA	87-90
	YFM350FWB/FWD/FEW/WWF	91-94
	YFM350XT/XU/XW/XA	87-90
	YFM350XB/XD/XE/XF/XG	91-95
RGU-206	YFB250FWJ-FWM	97-00
	YFB250UJ/UK	97-98
	YFM250M/MC	2000
	YFM250XL/XLC	2000
	YFM350FWJ/FWBJ	1997
	YFM350FH/FHLC	1999
	YFM350FWBK/FWBKC/FWBL/FWBLC	98-99
	YFM350UH/UJ/UK/UL/ULC	96-99
	YFM350FXG/FXH/FXJ/FXK	95-98
	YFM350FXL/FXLC/FXM/FXMC	99-00
	YFM350XH/XJ/XK/XKC	96-98
	YFM350XL/XLC/XM/XMC	99-00
	YFM400FWH/FWJ/FWK/FWL/FWLC	96-99
	YFM400FNNHH	2000
	YFM400FNNM/FNNMC	2000
	YFM400NM/NMC	2000
	YFM600FWAK	1998
	RGU-207	YFB250F/G
YFB250FWF/FWG/FWH		94-96
YFB250H/UH		1996
YFM350ERG		1995
YFM350FWG/FWH		95-96
YFM400FWE/FWF/FWG		93-95

RGU-214	YZF350 BANSHEE	94-01
	YFS200 BLASTER	94-01
RGU-229	YFM125	04-06
	YFM250	01-07
	YFM250B	05-06
	YFM25X	04
	YFM25W	07
	YFM350	04-07
	YFM350F	04
	YFM350R	05-06
	YFM350S	04-05
	YFM35B/F	05-07
	YFM35R	07
	YFM400A	00-02
	YFM4A	04
	YFM400F	00-06
	YFM4F	04
	YFM4F	06-07
	YFM450F	03
	YFM450F	05
YFM45F	04	
YFM45F	06-07	
YFM600F	99-01	
YFM660R	01-05	

SUZUKI

RGU-306	LT160EK/EL/EM/EN	89-92
	LT-F160M-K1	91-01
	LT-F250J-K1	88-01
	LT-F250FX/FY/FK1	99-01
	LT-F300FX/FY/FK1	99-01
RGU-307	LT-F250FK2	02
	LT-F300FK2	02

KAWASAKI

RGU-403	KLF300A1/A2 BAYOU	86-87
	KLF300B1/B2/B3/B4 BAYOU 300	88-91
RGU-404	KEF300A1/A2/A3/A4/A5/A6 LAKOTA	95-00
	KEF300B1/B2 LAKOTA SPORT	00-01
	KLF300B5/B6/B7/B8/B9 BAYOU	92-96
	KLF300B10/B11 BAYOU	97-98
	KLF300C1/C2/C3/C4 BAYOU 4X4	89-92
RGU-405	KLF300C5/C6/C7/C8/C9/C10 BAYOU	93-98
	KLT200A1/A2/A3/A4/A4A	81-83
RGU-407	KLT250A1	1982
	KLF110B1/B2 MOJAVE	87-88
RGU-408	KLF185A1/A1A BAYOU	1985
	KLF185A2/A3/A4 BAYOU	86-88
	KLF220A1/A2/A3/A4 BAYOU 220	88-91
	KLF220A5/A6/A7/A8 BAYOU 220	92-95
	KLF220A9/A10/A11/A12 BAYOU 220	96-99
RGU-409	KLF220A13/A14/A15 BAYOU 220	00-02
	KLF300C11/C12	99-00
	KVF300A1/A2 PRAIRIE 300	99-00
	KLF300B12/13 BAYOU	99-00

SEAT MOUNTING CUSHION FOR HONDA ATV

MC #	OEM REF	MODELS
SCR101-10	77207-HA0-000 (10 PCS/PACK)	TRX90 '93-07
		TRX200D '91-96
		TRX200 '90-91
		TRX250 '97-01
		TRX250EX '01-07
		TRX250TE '02-07
		TRX250TM '02-07
		TRX300EX '93-07
		TRX300FW '90-00
		TRX300 '90-00
		TRX300FE '00-06
		TRX350FM '00-06
		TRX350 '90-93
		TRX350TE '00-06
		TRX350TM '00-06
		TRX400EX '99-07
		TRX400FA '04-06
		TRX400FW '95-02
		TRX450ES '98-01
		TRX450FE '02-04
TRX450FM '02-04		
TRX450R '04-07		
TRX450S '98-01		
TRX500FA '01-07		
TRX500FE '05-07		
TRX500TM '05-06		
TRX650FA '03-07		

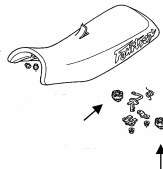

STEERING HEAD BEARING SET



SSH200

HONDA		
SSH200	ATC70/K1	73-74
	ATC70	78-85
	ATC90/K1/K2	71-78
	ATC110	79-85
	ATC125M	84-87
	ATC185	1980
	ATC185S	81-83
	ATC200	81-83
	ATC200E	82-83
	ATC200ES	1984
ATC200S	84-85	
SSH902	ATC250R	83-86

YAMAHA		
SSY080	YTM200 EX/EL	83-84
	YTM200 K/L	83-84
	YTM225DX K	83
SSY125	YTM200N/ERN TRI-MOTO	84-85
	YTM225DRN/DRS TRI-MOTO	85-86
	YTM225DX L/N	84-85

KAWASAKI		
SSH901	KXT250A1/A2 TECATE	84-85

STARTER SOLENOID RELAYS

HONDA		
SSR-201A	TRX300	88-00
	TRX300FW FOURTRAX	88-00

YAMAHA		
SSR-201	YFM80N/S/T/U MOTO-4	85-88
	YFM80D/E/F/G MOTO-4	92-95
	YFM80H-NC BADGER	96-01
	YFM100T-B CHAMP	87-91
	YFA1W BREEZE MOTO-4	89
	YFA1(B-R/RC) BREEZE	91-03
	YFU1W/TW PRO HAULER	89
	YFM200N MOTO-4	85
	YFM200XS-DXW MOTO-4	86-89
	YFM200EK/EL TRI-MOTO	83-94
	YTM200ERN TRI-MOTO	85
	YFM225S/T/U MOTO-4	86-88
	YTM225DXK-DXN TRI-MOTO	83-85
	YTM225DRN/DRS TRI-MOTO	85-86
	YFB250D-H TIMBERWOLF 2WD	92-96
	YFB250UH-UK TIMBERWOLF 2WD	96-98
	YFB250FWF-FWM TIMBERWOLF 4WD	94-00
	YFM250W/A/B MOTO-4	89-91
	YFP350U TERRA PRO	88
	YFM350ERT-ERA MOTO-4	87-90
YFM350ERD-ERG MOTO-4	92-95	
YFM350FWT-FWJ BIG BEAR 4WD	87-97	
YFM350FX(H-T) WOLVERINE 4WD	96-05	
YFM350XT-XR WARRIOR	87-03	
YFM400FWE-FWK KODIAK 4WD	93-99	
SSR-204	YFM600FWAK GRIZZLY	98



SSR-201A

SSR-208	YFM40FV BIG BEAR 400 4WD	06
	YFM45FAHV KODIAK 450 4WD HUNTER	06
	YFM40FT BIG BEAR 400 4WD	05
	YFM400FP-FWR BIG BEAR 400 4WD	02-03
	YFM40FS BIG BEAR 400 4WD	04
	YFM400NM-NR BIG BEAR 400 2WD	00-03
	YFM40S BIG BEAR 400 2WD	04
	YFM400FAM-FAR KODIAK 400 4WD	00-03
	YFM4FAS KODIAK 400 4WD	04
	YFM45FAS KODIAK 450 AUTO 4WD	04
YFM660FHP-FHRWL GRIZZLY HUNTER	02-03	
SSR-209	YFM350FXG WOLVERINE 4WD	95

VACUUM VALVE

YAMAHA		
VCC-Y201	YFM350FXH/FXJ/FXK/FXL/FXLC WOL	96-99
	YFM350FXM/FXMC/FXN/FXNC/FXP W	00-02
	YFM350FXR/FXS/FXT WOLVERINE	03-05
VCC-Y202	YFM350FWBJ/FWBK/FWBKC BIG BEAR	97-98
	YFM350FWBL/FWBLC BIG BEAR 4WD	1999
	YFM350FHL/FHLC BIG BEAR 4WD HUN	1999
	YFM350UL/ULC 2WD	1999
	YFM250XL/XLC/XM/XMC BEAR TRACK	99-00
	YFM350M	2000
	YFM250XHN BEAR TRACKER REAR TR	2001
	YFM250XHP BEAR TRACKER	2002
	YFM250XN/XP/XR/XS BEAR TRACKER	01-04
	YFM600FWAK/FWAKC/FWAL/FWALC	98-99
VCC-Y203	YFM600FHM/FHMC GRIZZLY REAR TR	2000
	YFM600FHN GRIZZLY REAR TREE HUN	2001
	YFM600FM/FMC/FN GRIZZLY	00-01
VCC-Y204	YFM250BT/BV BRUIN 250 2WD	05-06
	YFM25BW/BX BIG BEAR	07-08
	YFM35AS BRUIN 350 AUTO 2WD	2004
	YFM35FAS BRUIN 350 AUTO 4X4	2004
	YFM35BAT BRUIN 2WD	2005
	YFM350AV BRUIN 2WD	2006
	YFM35FAHT/FAHV BRUIN 350 4WD HU	05-06
	YFM35FAT/FAV BRUIN 350 4WD	05-06
	YFM35XV WOLVERINE 350 2WD	2006
	YFM35FGHX GRIZZLY	08
	YFM35FGIHW/FGIHX GRIZZLY 350	07-08
	YFM35FGIW/FGIX GRIZZLY 350	07-08
	YFM35FGW/FGX GRIZZLY 350	07-08



VCC-Y204	YFM35GW/GX GRIZZLY 350	07-08
	YFM35XV/XW/XX WOLVERINE 350	06-08
	YFM400AM/AMC/AN KODIAK 2WD	00-01
	YFM400AR KODIAK 2WD	2003
	YFM4AS KODIAK 2WD	2004
	YFM400FAHM/FAHMC KODIAK 4WD HUNTER	2000
	YFM400FAHN KODIAK 4WD REAR TREE HUNTER	2001
	YFM400FAM/FAMC/FAN KODIAK 4WD	00-01
	YFM400FAP/FAR KODIAK 4WD	02-03
	YFM400FHAP KODIAK 4WD HUNTER	2002
	YFM400FAHR/FAHS KODIAK 400 4X4 CAMO HEARDWOOD	03-04
	YFM400FHM BIG BEAR BUCKMASTER 4WD	2000
	YFM400FM/FMC/FN/FP BIG BEAR 4WD	00-02
	YFM400NM/NMC BIG BEAR 2WD	2000
	YFM400N/P BIG BEAR 2WD	01-02
	YFM400HN BIG BEAR 2WD REAR TREE HUNTER	2001
	YFM400HP BIG BEAR 2WD HUNTER	2002
	YFM400FHN/FHP BIG BEAR 4WD REAL TREE HUNTER	01-02
	YFM400FWR BIG BEAR 4WD	2003
	YFM40FS/FT/FV BIG BEAR 400 4X4	04-06
YFM40S BIG BEAR 400 2WD	2004	
YFM40FBW/FBX BIG BEAR 400 4WD	07-08	
YFM40FBHW/X BIG BEAR 400 4WD HUNTER	07-08	
YFM4FAHS KODIAK 400 AUTO 4X4 HARDWOOD	2004	

VCC-Y204	YFM4FAS KODIAK 400 4X4	2004
	YFM4FAHT/FAHV KODIAK 400 4WD HUNTER	05-06
	YFM4FAT/FAV KODIAK 400 4WD	05-06
	YFM4FGHW /FGHX GRIZZLY 400 4WD HUNTER	07-08
	YFM4FGW/FGX GRIZZLY 400 FWD	07-08
	YFM450FAHR KODIAK 450 REAL TREE EDITION	2003
	YFM450FAR/FAS KODIAK 450 4WD	03-04
	YFM45FAHS KODIAK AUTO 4X4 GARDY	2004
	YFM45FAS KODIAK 450 AUTO 4X4	2004
	YFM45FAHT/FAHV KODIAK 450 4WD HUNTER	05-06
	YFM45FAT/FAV KODIAK 450 4WD	05-06
	YFM45FSET KODIAK 450 4WD BLACK	2005
	YFM45FASEV KODIAK 450 4WD SPECIAL EDITION	2006
	YFM45FGHW /FGHX GRIZZLY 450 HUNTER	07-08
	YFM45FXV/FXX WOLVERINE 4X4 SPORT	06-08
	YFM45FXSEW WOLVERINE	08
	YFM660RN/RNC/RP/RR/RS/RT RAPTOR	01-05
	YFM660RPB RAPTOR LIMITED EDITION	2002
	YFM660RLER	2003
	YFM660RLES RAPTOR LIMITED EDITION	2004
YFM660RSET RAPTOR SE	2005	
YXR45FHW/FHX RHINO 450 HUNTER SPORT	07-08	
YXR45FSEW RHINO 450	07	
YXR45FSPX RHINO 450	08	
YXR45FXR RHINO 450	08	
VCC-Y205	YFM350RS/RT/RV/RW/RX RAPTOR 350	04-08
VCC-Y206	YFM350RSET/RSEV /RSEW RAPTOR 350	05-07
VCC-Y206	YFM660FHP GRIZZLY 660 HUNTER EDITION	2002
	YFM660FPS GRIZZLY 660 SILVER	2002
	YFM660FP/FR/FS GRIZZLY 660	02-04
	YFM660FHRWL GRIZZLY WETLANDS HUNTER EDITION	2003
	YFM660FHRH GRIZZLY REAR TREE HUNTER EDITION	2003

VCC-Y206	HUNTER	
	YFM660FRGY GRIZZLY 660 4X4 METALLIC TITANIUM	2003
	YFM660FR	2003
	YFM660FHSWL	2004
	YFM660FHS GRIZZLY 660 HARDWOOD HUNTER CAMO	2004
	YFM660FLES GRIZZLY 660 AUTO 4X4 LIMITED EDITION	2004
	YFM660FAHT GRIZZLY 660 HUNTER	2005
	YFM660FAHWT GRIZZLY 660 HUNTER WETLAND	2005
	YFM660FASET GRIZZLY 660 SE	2005
	YFM660FAT/FAV GRIZZLY 660	05-06
	YFM660FAHDV GRIZZLY 660 DUCKS UNLIMITED EDITION	2006
	YFM660FAHV GRIZZLY HARDWOOD HD CAMO	2006
YFM660FASEV GRIZZLY 660 SPECIAL EDITION	2006	

SUZUKI		
VCC-S301	LT-F250 2WD	90-99
	LT-F250F 4WD	1999
	LT-F300F KING QUAD	1999
	LT-F4WD	90-95
	LT-F4WD QUAD RUNNER	96-98
VCC-S302	LT-F4WDX KING QUAD	91-98
	LT-F250 2WD	00-01
	LT-F250F 4WD QUAD RUNNER	00-02
VCC-S303	LT-F300F 4WD KING QUAD	00-02
	LT-F250 OZARK 250 2WD	02-09
VCC-S304	LT-Z250 QUAD SPORT	05-09
	LT-Z400 QUAD SPORT	03-08
VCC-S305	LT-F500F QUAD MASTER 4WD	98-01
	LT-F500F VINSON 4WD	2002

VALVE STEM SEALS

HONDA			
VSS-106	ATC125M	84-85	
	ATC125M	86-87	
	TRX125 FOURTRAX 125	85-86	
	TRX125 FOURTRAX 125	87-88	
	ATC185	1980	
	ATC185S	81-83	
	ATC200	81-83	
	ATC200E BIG RED	82-83	
	ATC200ES BIG RED	1984	
	ATC200M	84-85	
	ATC200S	84-86	
	ATC200X	83-85	
	ATC200X	86-87	
	TRX200 FOURTRAX 200	1984	
	TRX200 FOURTRAX 200	90-91	
	TRX200 FOURTRAX TYPE II	91-97	
	TRX200SX FOURTRAX	86-88	
	ATC200ES BIG RED	85-86	
	ATC250ES BIG RED	1987	
	ATC250SX	85-86	
	ATC250SX	1987	
	TRX250 FOURTRAX 250	85-86	
	TRX250 FOURTRAX 250	1987	
	TRX250 RECON	97-01	
	TRX250TE RECON ES	2002	
	TRX250TM RECON	2002	
	TRX250X FOURTRAX	87-88	
	TRX250X FOURTRAX	91-92	
	TRX300 FOURTRAX 300	88-00	
	TRX300EX FOURTRAX 300	93-01	
	TRX300FW FOURTRAX 4X4	1988	
	TRX300FW FOURTRAX 4X4	90-00	
	ATC350X	85-87	
	TRX350 FOURTRAX 4X4	86-87	
	TRX350 FOURTRAX FOREMAN	87-89	
	TRX400FW FOURTRAX	95-01	
	TRX450S FOURTRAX	98-02	
	TRX450ES FOURTRAX	98-02	
	YAMAHA		
	VSS-201	YFM350ERT/ERU/ERW	87-89
		YFM350ERA/ERB/ERD	90-92
		YFM350ERE/ERF/ERG	93-95
		YFM350FHL BIG BEAR 4X4	1999
		YFM350FWT/FWU BIG BEAR	87-88
		YFM350FWW-FWJ BIG BEAR	89-97
YFM350FWB BIG BEAR		97-99	
YFM350UH-UL BIG BEAR		96-99	
YFM350FXG-FXN WOLV.		95-01	
YFM350XT-XG WARRIOR		87-95	
YFM350XH-XN WARRIOR		96-01	
YFP350P TERRAPRO		1988	
YFM400FWE/FWF KODIAK		93-94	
FM400FWG-FWL KODIAK		95-99	
YFM400AM/AMC KODIAK		2000	
YFM400FAM/FAHM KODIAK		2000	
YFM400FWNHM BIG BEAR		2000	



VSS-201	YFM400FWNM BIG BEAR	2000
	YFM400NM BIG BEAR	2000
	YFM600FWA GRIZZLY	98-00
	YFM600HM/HMC GRIZZLY	2000
	YFM200DXS/DXT MOTO-4	86-87
VSS-205	YFM200DXU/DXW	88-89
	YFM200N MOTO-4	1985
	YTM200ERN TRI-MOTO	1985
	YTM200K/L/N TRI-MOTO	83-85
	YTM200EK/EL TRI-MOTO	83-84
	YFM225S/T/U MOTO-4	86-88
	YTM225DRN/S TRI-MOTO	85-86
	YFU1W/TW PROHAULER	1989
	YFB250D-F TIMERWOLF	92-94
	YFB250G/H TIMERWOLF	95-96
	YFB250FWF-FWM	94-00
	YFB250UH-UK TIMERWOLF	96-98
	YFM250W/A/B MOTO-4	89-91
	YFM250XL/XLC	1999
	YFM250M/MC BEARTRACKER	2000
SUZUKI		
VSS-303	ALT125D/E	83-84
	ALT125F/G	85-86
	LT125D/E	83-84
	LT125F/G/H	85-87
	LT160EK/EL/EM/EN	89-92
	LT-F160M/N/P/R/S/T	91-96
	LT-F160V/W/X/Y/K1	97-01
	ALT185F	1985
	LT185E/F/G/H	84-87
	LT230EH/EJ/EK	87-89
	LT230EL/EM/EN/EP	90-93
	LT230GEF/GEG	85-86
	LT230SF/SG/SH/SJ	85-88
	LT-F230G/H	86-87
	LT250EFF/EFH	85-86
	LT250SK/SL	89-90
	LT-F250J/K/L/M	88-91
	LT-F250N/P/R/S/T	92-96
	LT-F250V/W/X/Y/K1	97-01
	LT-F250FX-FK1	99-01
LT300EH/EJ/EK	87-89	
LT-F300FX-FK1	99-01	
LT-4WDH/WDJ/WDK	87-89	
LT-4WDL/WDM/WDN	90-92	
LT-4WDP/WDR/WDS	93-95	
LT-4WDT-WDW	96-98	
LT-F4WDXM/WDXN	91-92	
LT-F4WDXP/WDXR	93-94	
LT-F4WDXS/WDXT	95-96	

VSS-303	LT-F4WDXV/WDXW	96-98
	LT-F500F	98-01
	LT-A500F	00-01
KAWASAKI		
VSS-401	KLT200A1-A4A	81-83
	KLT200B1	1983
	KLT200C1/C2	83-84
	KLT250A1/A2	82-83
	KLT250C1-C3 PRAIRIE	83-85
	KLT250P1 POLICE	1984
	KEF300A1-A7 LAKOTA	95-01
	KLF300A1/A2 BAYOU	86-87
	KLF300B1-B14 BAYOU	88-01
	KLF300C1-C13 BAYOU 4WD	89-01
	KVF300A1-A3 PRAIRIE 4WD	99-01
	KVF300B1-B3 PRAIRIE 300	99-01

VSS-403	KLF110A1/A2 MOJAVE	87-88
	KLF110B1/B2 MOJAVE	87-88
	KLT110A1/A2/A3	84-86
	KLT160A1	1985
	KLF185A1/A1A BAYOU	1985
	KLF185A2/A3/A4 BAYOU	86-88
	KLT185A1/A2 BAYOU	86-87
	KLF220A1-A14 BAYOU	88-01
	KLF400B1-B7 BAYOU 4X4	93-99
	KVF400A1-A2 PRAIRIE 4WD	97-98
	KVF400B1 PRAIRIE 400	1998
	KVF400C1-C3 PRAIRIE 4WD	99-01
	KVF400D1-D3 PRAIRIE 400	99-01

FRONT BRAKE WHEEL CYLINDER SEALING KIT



WCK-101	(1 CYLINDER KIT)	
	2 X PISTON CUP	
	2 X PISTON CUP	
	2 X CYLINDER BOOT	
	1 X RUBBER CAP	
	TRX200	90-91
	TRX200D	91-94
	TRX300	88-96
WCK-102	(2 CYLINDER KIT)	
	2 X PISTON CUP	
	2 X CYLINDER BOOT	
	1 X RUBBER CAP	
	TRX300FW	88
	TRX300FW	90-96
	TRX400FW	95-98
WCK-201	(2 CYLINDER KIT)	
	2 X CUP SET	
	1 X RUBBER CAP	
	YFM350FWT/FWU/FWW/FWA/FWB/FWD BIG BEAR	87-92
	YFM350FWE/FWF/FWG/FWH/FWJ BIG BEAR	93-97
	YFM350FWBJ BIG BEAR	97
	YFM350UJK	88
YFM400FWH/FWJ/FWK	96-98	

WATER PUMP MECHANICAL SEALS



WMS-901	HONDA	
	ATC250R	86-87
	TRX250R FOURTRAX	87-89
	YAMAHA	
	YFM400AM/AN KODIAK 2WD	00-01
	YFM400AMC KODIAK 2WD	00
	YFM400FA(P/R) KODIAK 4WD	02-03
	YFM4FA(S,T/V) KODIAK 400 4WD	04-06
	YFM4FAHS KODIAK 400 4WD AUTO HARDWOODS	04
	YFM450FAHR KODIAK 450 REAL TREE	03
	YFM45FAHS KODIAK 450 AUTO 4WD HARDWOODS	04
	YFM45FAH(T/V) KODIAK 450 4WD HUNTER	05-06
	YFM45FAS KODIAK 450 AUTO 4WD	04
	YFM450FAS	04
	YFM45FAT/FAV KODIAK 450 4WD	05-06
	YFM45FASEV KODIAK 450 4WD SPECIAL EDITION	06
	YFM45FXV WOLVERINE 450 4WD	06
	YFM45FSET KODIAK 450 4WD BLACK CARBON	05
	YFM660FHSWL	04
	YFM660FHS GRIZZLY 660 HARDWOODS HUNTER CAMO	04
	YFM660FLES GRIZZLY 660 AUTO 4WD LIMITED EDITION	04
	YFM660FS GRIZZLY 660	04
	YFM660RLES RAPTOR LIMITED EDITION BLACK	04
	YFM660RS RAPTOR 660	04
	YFM660RSET RAPTOR SE	05
	YFM660RT RAPTOR 660	05
	YFM66FAHT GRIZZLY 660 HUNTER	05
	YFM66HAHWT GRIZZLY 660	05

WMS-901	HUNTER WETLAND		
	YFM66FASET GRIZZLY 660 SE	05	
	YFM66FAT GRIZZLY 660	05	
	YFM66FAHDV GRIZZLY 660 DUCKS UNLIMITED EDITION	06	
	YFM66FAHV GRIZZLY 660 HUNTER HARDWOODS HD CAMO	06	
	YFM66FASEV GRIZZLY 660 SPECIAL EDITION	06	
	YFM66FAV GRIZZLY 660	06	
	YFM700RSPV RAPTOR 700 50TH ANNIVERSARY	06	
	YFM700RV RAPTOR 700	06	
	WMS-902	KAWASAKI	
KSF250A1-A17 MOJAVE		87-03	
WMS-904	SUZUKI		
	LT250R QUAD RACER	85-92	
	LT-Z400 QUAD SPORT	05-06	
	LT500R QUADZILLA	87-90	
	LTA500F 4WD VINSON AUTOMATIC	02-06	
	LTF500 4WD VINSON	05-06	
	LTF500F 4WD VINSON	02-04	
	LTF500F 4WD VINSON CAMO	06	
	LTF500F QUAD MASTER	98-01	
	LTA500F QUAD MASTER AUTOMATIC	00-01	
	LTA700X 4WD KING QUAD AUTOMATIC	05-06	
	WMS-905	SUZUKI	
		LT-Z400 QUAD SPORT	03-04
WMS-908	HONDA		
	TRX450ER	06	
	TRX450R	04-06	

BRAKE PARTS

*CPKxxx(quantity requested per model)

*R&L : In case of double disc models
Front caliper seal kit is for
both Right and
Left

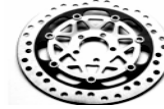

MODEL	YEAR	CALIPER SEALING KIT		CALIPER PISTON KIT		ROTOR	
		FRONT	REAR	FRONT	REAR	FRONT	REAR

HONDA

CB750F SUPERSPORT	77-80	R&L	BCF-101						
CB750F Z	79	R&L	BCF-101	BCR-101					
CB750F A	80	R&L	BCF-101	BCR-101	CPK-107(2)				
CB750F B	81	R&L	BCF-101	BCR-101	CPK-107(2)				
CB750F C/2C	82	R&L	BCF-102	BCR-102	CPK-101(4)	CPK-110(2)			
CB750SC	82-83	R&L	BCF-102		CPK-101(4)				

KAWASAKI

KZ650B1	77		BCF-402		CPK-404(1)				
KZ650B2-B3	78-79		BCF-402		CPK-404(1)				
Z650C1	77				CPK-402(2)				
Z650C2	78				CPK-402(2)				
Z650C3	79				CPK-403(2)				
KZ650C4	80	R&L	BCF-404	BCR-402					
Z650D1	78				CPK-402(2)	CPK-406(2)			
Z650D2	79			BCR-402	CPK-403(2)	CPK-405(2)			
KZ650D3	80	R&L	BCF-404	BCR-402					
KZ650E1 LTD	80		BCF-402		CPK-403(1)				
KZ650F1	80		BCF-402		CPK-403(1)				
Z650F2/F3	81-82	R&L	BCF-403				DRF-409		
KZ650H1-H3	81-83		BCF-401		CPK-401(1)				
KZ900A4/A5	76-77		BCF-402						
KZ900B1 LTD	76	R&L	BCF-404	BCR-403					
Z1 Z1A/B 900	73-75								
KZ1000A1	77	R&L	BCF-404	BCR-402	CPK-404(2)	CPK-406(2)			
KZ1000A2	78	R&L	BCF-404	BCR-402	CPK-402(2)	CPK-406(2)			
KZ1000A3/A4	79-80	R&L	BCF-404	BCR-402	CPK-403(2)	CPK-405(2)			
KZ1000B1	77	R&L	BCF-404		CPK-402(2)				
KZ1000B2 LTD	78	R&L	BCF-404		CPK-402(2)				
KZ1000B3-B4 LTD	79-80	R&L	BCF-404	BCR-402	CPK-403(2)	CPK-405(2)			
KZ1000C1	78			BCR-402		CPK-405(2)			
KZ1000C1A POLICE	78			BCR-402					
KZ1000G2/C3/C4	79-81	R&L	BCF-404	BCR-402	CPK-403(2)	CPK-405(2)			
KZ1000D1 Z1R	78			BCR-402	CPK-402(2)	CPK-406(2)			
KZ1000D3 Z1R	80	R&L	BCF-404	BCR-402	CPK-403(2)	CPK-405(2)			
KZ1000E1/E2	79-80	R&L	BCF-404	BCR-402	CPK-403(2)	CPK-405(2)			
KZ1000G1	80	R&L	BCF-404	BCR-402	CPK-403(2)	CPK-405(2)			
KZ1000J1/J2	81-82	R&L	BCF-403	BCR-401	CPK-401(2)	CPK-401(1)	DRF-412	DRR-405	
KZ1000J3	83	R&L	BCF-403	BCR-401	CPK-401(2)	CPK-401(1)			
KZ1000K1/K2 LTD	81-82	R&L	BCF-403	BCR-401	CPK-401(2)	CPK-401(1)	DRF-412	DRR-405	
KZ1000M1/M2	81-82	R&L	BCF-403	BCR-401	CPK-401(2)	CPK-401(1)		DRR-405	

SUZUKI

GS750 B/C/N	77-79			BCR-301					
GS750E C/N	78-79			BCR-301					
GS750E D	83							CPK-305(2)	
GS750L T/X	80-81	R&L	BCF-307			CPK-307(2)		CPK-308(2)	
GS750S D	83							CPK-308(2)	
GS1000 C/N	78-79			BCR-301					
GS1000 T	80	R&L	BCF-303	BCR-301					
GS1000E C/N	78-79			BCR-301					
GS1000E T	80	R&L	BCF-303	BCR-301				CPK-308(2)	
GS1000G T/X	80-81	R&L	BCF-307	BCR-301		CPK-307(2)		CPK-308(2)	
GS1000GL T/X	80-81	R&L	BCF-307	BCR-301		CPK-307(2)		CPK-308(2)	
GS1000H C/N	78-79			BCR-301					
GS1000H T	80	R&L	BCF-303	BCR-301					
GS1000L N	79			BCR-301					
GS1000S N	79			BCR-301					
GS1000S T	80	R&L	BCF-303	BCR-301				CPK-308(2)	
GS1000S Z	82	R&L	BCF-303	BCR-301				CPK-308(2)	
GS1000S D	83	R&L	BCF-303	BCR-301					

YAMAHA

XS650 D/E/F single disc	77-79		BCF-201						
XS650 D/E/F double disc	77-79		BCF-202						
XS650 double discs	80		BCF-202						
XS650G special II	80		BCF-201						
XS650H single disc	81		BCF-201						
XS650H double disc	81		BCF-202						
XS650S E/F/G single disc	78-80		BCF-201	BCF-201					
XS650S E/F/G double disc	78-80		BCF-202	BCF-201					
XS650S H	81		BCF-201						
XS650S J/SK single disc	82-83		BCF-201						
XS650S J/SK double discs	82-83		BCF-202						
XS750 D/2D/E/F	77-79	R&L	BCF-202	BCF-201					
XS750S E/F	78-79	R&L	BCF-206	BCF-201					
XS850 G/H	80-81	R&L	BCF-202	BCF-201					
XS850L G/H	80-81	R&L	BCF-206	BCF-201					
XS850S F	79		BCF-201	BCF-201					
XS850S G/H	80-81	R&L	BCF-206	BCF-201					
XS1100 E/F/G/H	78-81	R&L	BCF-202						
XS1100L G MIDNIGHT SPECIAL	80	R&L	BCF-206	BCF-201					
XS1100L H MIDNIGHT SPECIAL	81	R&L	BCF-204						
XS1100S F/G	79-80	R&L	BCF-206	BCF-201					
XS1100S H	81			BCF-201					

BEARINGS



MODEL	STEERING HEAD	SWING ARM	SWING ARM with COLLAR	FRONT WHEEL	REAR WHEEL
-------	---------------	-----------	-----------------------	-------------	------------

HONDA

CB750K1-K6	69-76	SSH750		SNB-104	WBK-017	WBK-156
CB750K7	77	SSH750			WBK-017	WBK-041
CB750F1/F2	77-78	SSH750		SNB-104	WBK-018	WBK-041
CB750A	76-78	SSH750			WBK-018	WBK-156
CB750K Z	79	SSH901		SNB-105	WBK-018	WBK-156
CB750K A/B	80-81	SSH903			WBK-018	WBK-156
CB750FZ	79	SSH901		SNB-105	WBK-018	WBK-041
CB750F A/B/C	80-82	SSH903	SAB-101	SWS-101	WBK-018	WBK-041
CB750FII C	82	SSH903	SAB-101	SWS-101	WBK-018	WBK-041
CB750C	80-82	SSH903			WBK-018	WBK-156
CB750SC	82-83				WBK-019	WBK-156

KAWASAKI

KZ650B1-B2	77-79	SSK400			WBK-083	WBK-146
KZ650B3	77-79	SSK400				
KZ650C1	77	SSK400			WBK-083	WBK-208
KZ650C2-C3	78-79	SSK400	SAB-402/SAO-403	SWS-410	WBK-083	WBK-208
KZ650C4	80				WBK-083	WBK-208
KZ650D1-D2	78-79	SSK400	SAB-402/SAO-403	SWS-410	WBK-083	
KZ650E1	80	SSK400	SAB-402/SAO-403	SWS-410	WBK-083	WBK-147
KZ650F1	80	SSK400	SAB-402/SAO-403	SWS-410	WBK-083	WBK-146
KZ650F2-F3	81-82				WBK-163	WBK-147
KZ650H1	81	SSK400	SAB-402/SAO-403	SWS-410	WBK-163	WBK-147
KZ650H2	82	SSK400	SAO-402	SWS-411	WBK-163	WBK-147
KZ650H3	83	SSK400	SAO-402	SWS-411	WBK-163	WBK-147
Z1 900	73	SSK400		SNB-406	WBK-141	WBK-087
Z1A 900	74	SSK400		SNB-406	WBK-141	WBK-087
Z1B 900	75	SSK400		SNB-406	WBK-141	WBK-087
Z900A4-A5	76-77	SSK400		SNB-406	WBK-083	WBK-087
KZ900 B1	76	SSK400			WBK-084	WBK-093
KZ1000A1	77	SSK400			WBK-083	WBK-094
KZ1000A2-A4	78-80	SSK400	SAB-402/SAO-403	SWS-415	WBK-083	WBK-094
KZ1000B1-B4	77-80	SSK400	SAB-402/SAO-403	SWS-415	WBK-083	WBK-094
KZ1000D Z1-R	78-80	SSK400	SAB-402/SAO-403	SWS-415	WBK-083	WBK-094
KZ1000E1/E2	79-80	SSK901			WBK-084	
KZ1000G1	80	SSK400	SAB-402/SAO-403	SWS-415	WBK-084	WBK-094
KZ1000H1	80				WBK-083	WBK-094
KZ1000J1-J2	81-82	SSK902	SAO-417	SWS-416	WBK-188	WBK-202
KZ1000J3	83	SSK902			WBK-163	WBK-202
KZ1000K1-K2	81-82	SSK902	SAO-417	SWS-416	WBK-188	WBK-202
KZ1000M1-M2	81-82	SSK902	SAO-417	SWS-416	WBK-163	WBK-202
KZ1000R1	82	SSK902	SAO-417	SWS-416	WBK-188	WBK-202
KZ1000R2	83	SSK902	SAO-417	SWS-416	WBK-163	WBK-202

SUZUKI

GS750	77	SSS250	SAB-307		WBK-075	WBK-138
GS750	78-79	SSS250	SAB-307	SWS-301	WBK-075	WBK-138
GS750D	78	SSS250	SAB-307	SWS-301	WBK-075	WBK-138
GS750D	79	SSS250	SAB-307		WBK-075	WBK-138
GS750E	78-79	SSS250	SAB-307	SWS-301	WBK-075	WBK-138
GS750L	79	SSS250	SAB-307	SWS-301	WBK-075	WBK-138
GS750L	80-81	SSH901	SAB-307	SWS-301	WBK-075	WBK-138
GS750S	83	SSH901	SAB-308	SWS-302	WBK-075	WBK-138
GS750T	82-83	SSH901	SAB-307	SWS-301	WBK-075	WBK-138
GS1000	78-80	SSH901	SAB-308	SWS-302	WBK-075	WBK-138
GS1000E	78-80	SSH901	SAB-308	SWS-302	WBK-075	WBK-138
GS1000G	80-81	SSH901			WBK-075	WBK-119
GS1000GL	80-81	SSH901			WBK-075	WBK-119
GS1000H	78-80	SSH901	SAB-308	SWS-302	WBK-075	WBK-138
GS1000S	79-82	SSH901	SAB-308	SWS-302	WBK-075	WBK-138
GS1000L N	79	SSH901	SAB-308	SWS-302	WBK-075	WBK-138

YAMAHA

XS1/XS1B	70-71				WBK-049	WBK-061
XS650	75				WBK-050	WBK-061
XS650	76-77	SSY500		SNB-201	WBK-050	WBK-061
XS650	78	SSY500		SNB-201	WBK-050	WBK-061
XS650	79	SSY500		SNB-201	WBK-050	WBK-061
XS650 G/H	80-81	SSY500		SNB-201	WBK-050	WBK-061
XS650 J/K	82-83	SSY500		SNB-201		
XS650S	78-81	SSY500			WBK-050	WBK-061
XS650S HEGITAGE	82-83	SSY500			WBK-050	WBK-061
XS750	78-79	SSH901			WBK-050	WBK-062
XS750SE	80	SSH901			WBK-050	WBK-062
XS750S	78-79	SSH901			WBK-050	WBK-062
XS850	80-81	SSH901			WBK-050	
XS850S	80-81	SSH901			WBK-050	
XS850L	80-81	SSH901			WBK-050	
XS1100	78-79				WBK-050	
XS1100	80-81	SSH901	SAO-210		WBK-050	
XS1100S	79-81	SSH901	SAO-210		WBK-050	
XS1100L	80-81				WBK-050	

CLUTCH PARTS

remarks:

CLUTCH PLATE

SET:

On the item marked

(*),

You need to add Clutch plate B additionally. It is not included in set



MODEL	YEAR	FRICITION DISC SET	H.D SPRING SET	CLUTCH PLATE SET
HONDA				
CB750K1-K5	71-75	CDF-177		CPL-0002 *
CB750K	76	CDF-115		CPL-0002
CB750F	77-78	CDF-115		CPL-0001 *
CB750L	79	CDF-103	HSP-104 6	
CB750K Z/A/B	79-81	CDF-103	HSP-104 6	CPL-0004 *
CB750FZ	79	CDF-103	HSP-104 6	CPL-0004 *
CB750FA/FB/FC	80-82	CDF-103	HSP-104 6	CPL-0004 *
CB750C	80-82	CDF-103	HSP-104 6	CPL-0004 *
CB750F2C	82	CDF-103	HSP-104 6	CPL-0004 *
CB750SC	82-83	CDF-103	HSP-104 6	CPL-0004 *

YAMAHA

XS650 <1U3>	80	CDF-214	HSP-208 6	
XS650 G/H/SH/SJ SPECIAL II	80-82	CDF-214	HSP-208 6	
XS650 SK HERITAGE SPEICIAL	83	CDF-214	HSP-208 6	
XS750	77	CDF-206	HSP-208 6	
XS750 E/F/SF/SE/	78-79	CDF-206	HSP-208 6	
XS750 SE <3L3>	80	CDF-206	HSP-208 6	
XS1100	80	CDF-232	HSP-208 6	

KAWASAKI

KZ650 B	77-79	CDF-411	HSP-401 5	CPL-0084
KZ650 C	77-79	CDF-411	HSP-401 5	CPL-0084
KZ650 D	78-79	CDF-411	HSP-401 5	CPL-0084
KZ650 F1/E1	80	CDF-411	HSP-401 5	CPL-0084
KZ650 H	81-83	CDF-411	HSP-401 5	CPL-0084
KZ900 A	76-77	CDF-412	HSP-401 5	CPL-0085
KZ900 B1 LTD	76	CDF-412	HSP-401 5	CPL-0085
Z1 SERIES	73-75	CDF-412	HSP-401 5	CPL-0085
KZ1000 A SERIES	77-80	CDF-412	HSP-401 5	CPL-0085
KZ1000 B SERIES	77-80	CDF-412	HSP-401 5	CPL-0085
KZ1000 D Z1R	78/80	CDF-412	HSP-401 5	CPL-0085
KZ1000 E SHAFT		CDF-402	HSP-403 6	CPL-0080
KZ1000J1/J2/J3	81-83	CDF-402	HSP-401 5	CPL-0080
KZ1000K1/K2	81-82	CDF-402	HSP-401 5	CPL-0080
KZ1000M1/M2	81-82	CDF-402	HSP-401 5	CPL-0080
Z1000 R1	82	CDF-402	HSP-401 5	CPL-0080
Z1000 R2	83	CDF-402	HSP-401 5	CPL-0080

SUZUKI

GS750 C/DC/EC/N/DN /EN	78-79	CDF-312	HSP-305 6	CPL-0055
GS750B/C/EC/N /EN	77-79	CDF-312	HSP-305 6	CPL-0055
GS750SD KATANA	83	CDF-307		
GS750LN	79	CDF-312	HSP-305 6	CPL-0055
GSX750 (W/X/Y)	98-00	CDF-322P	HSP-310 4	
GS1000ST	80	CDF-232		
GS1000 C/HC/EC	78	CDF-232	HSP-305 6	
GS1000 N/HN/EN	78-79	CDF-232	HSP-305 6	
GS1000SN	79	CDF-232	HSP-305 6	

FRONT FORK REPAIR PARTS



MODEL	FSM	FSD	FSB	FRK
-------	-----	-----	-----	-----

HONDA

CB750A		76-78	FSM-003T			
CB750K1-K6		69-76	FSM-003T			
CB750K7		77	FSM-003T			
CB750C		80-82	FSM-003T	FSD-002		
CB750F	A/B/C	80-82	FSM-003T	FSD-002		
CB750F1/F2		77-78	FSM-003T	FSD-002		
CB750K	Z/A/B	79-81	FSM-003	FSD-002		
CB750FII	C	82	FSM-003T	FSD-002		
CB750L		79	FSM-003T	FSD-002		
CB750SC		82-83	FSM-044	FSD-003		

KAWASAKI

KZ650	B1-B3	77-78	FSM-001			
KZ650	C1-C3	77-79	FSM-001			
KZ650	D1-D2	78-79	FSM-001			
KZ650	E1		FSM-001			
KZ650	F1	80	FSM-001			
KZ650	H1-H3	81-83	FSM-046			
KZ900	A4-A5	76-77	FSM-001			
KZ900	B1	76	FSM-001			
Z1 900		73	FSM-003			
Z1A 900		74	FSM-003			
Z1B 900		75	FSM-003			
KZ1000	A1-A4	77-80	FSM-001			
KZ1000	B1-B4	77-80	FSM-001			
KZ1000	C1	78				
KZ1000	D1/D3	78/80	FSM-001			
KZ1000	E1-E2	79-80	FSM-033			
KZ1000	G1	80	FSM-001			
KZ1000	J1-J3	81-83	FSM-032			
KZ1000	K1-K2	81-82	FSM-032			
KZ1000	M1/M2	81-82	FSM-032			
KZ1000	P5-P19	96-00	FSM-032			
KZ1000	R1/R2	82-83	FSM-032			

SUZUKI

GS750	B,C	77-78	FSM-003R	FSD-019		
GS750	N	79	FSM-003T	FSD-019		
GS750D	B,C	77-78	FSM-003R	FSD-019R		
GS750D	N	79	FSM-003T	FSD-019		
GS750E	C	78	FSM-003R	FSD-019R		
GS750E	N	79	FSM-003T	FSD-019		
GS750L	N/T	79-80	FSM-044			
GS750S	D	83	FSM-027			
GS750T	Z,D	82-83	FSM-003T			
GS1000	C /N/T	78-80	FSM-027			
GS1000E	C/N/T	78-80	FSM-027			
GS1000G	T-G	80-86	FSM-027			
GS1000GL	X	81	FSM-027			
GS1000H	C/N/T	78-80	FSM-027			
GS1000L	N	79	FSM-027			
GS1000S	N	79	FSM-027			

YAMAHA







XS650	B/C	75-76	FSM-002		
XS650	D/E/F/G	77-81	FSM-003		
XS650S	E/F/G/H	78-83	FSM-003		
XS650SE		80-81	FSM-003		
XS750	D	77	FSM-003T		
XS750	E/F	78-79	FSM-025	FSD-020	
XS750SE		78-79	FSM-025	FSD-020	
XS750S	E/F	78-79	FSM-025	FSD-020	
XS850	G/H	80-81	FSM-025	FSD-020	
XS850L	G/H	80-81	FSM-046		
XS850S	G/H	80-81	FSM-046		
XS1100	E/F/G/H	78-81	FSM-027		
XS1100S	F/G/H	79-81	FSM-007		

CONTAINS



	FSM	FSD	FSB	FRK
FORKL SEAL	2	2	2	1
DUST SEAL		2		1
DU BUSH Inner			2	1
DU BUSH Outer			2	1
CIR CLIP				1



CARBURETOR REPAIR KIT

HONDA

CAB-H1 	CB250T/N/NA/NC'78-80 CB400N/NA/NC'79-82 CB400T'78 CX500 '78-79 CX500C '79 CX500D '79 CB650Z'79 CB650'79-80 CB750KZ'79 CB900FZ'79 CB900FA'80 <VB51A(A)> CBX Z-C'80-82 CB250NDC'82
CAB-H2 	CX500 A/B'80-81 CX500C A/B/C'80-83 CB650'81-82 CB750FA/FB/FC/F2C'80-81 CB750K'80 CB900FA'80 <VB51A(B)> CB1100R B/C/D'81-83 CB900FB/FC/F2C'81-82
CAB-H5 	GL1100'80-83 GL1100A ASPENCADE'82-83 GL1100I INTERSTATE'80-83
CAB-H11 	CB/CL350 '68-73
CAB-H12 	CB500/K1/K2 '71-73
CAB-H13 	CB750K3/K4/K5 '73-75
CAB-H14 	CB550K0/K1 '74-75

KAWASAKI

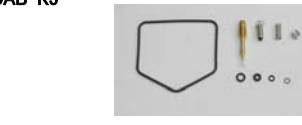
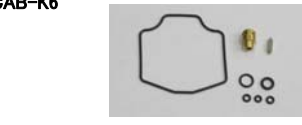

CAB-K1 	KZ1000A1-A2'77-78 KZ1000B1-B2'77-78 KZ900A4/F5'76-77
CAB-K2 	KZ1000A3/A4'79-80 KZ1000B3/B4'79-80 KZ1000C3/C4'80-81 KZ1000D3'80

CAB-K3 	KZ750R1 GPZ'82 KZ750L3'83 ZX750A1/A2/A3'83-85 KZ1000M1/M2 LTD'81-82 KZ1000K1/K2 LTD'81-82 KZ1000J1/J2'81-82 KZ1000R1/R2 REPLICAS'82-83
CAB-K5 	KZ440A1-A4 LTD'80-83 KZ440B1/B2'82-83 KZ440D1-D5 LTD'80-83 KZ440G1'82 KZ750E1/E2/E3'80-82 KZ750H1-H4 LTD'80-83 KZ750N1/N2 SPECTRE'82-83
CAB-K6 	KZ550H1/H2'82-83 KZ550F1/F2'84-85 KZ550M1 LTD ZX550
CAB-K8 	Z1,Z1A/B'73-75

YAMAHA

CAB-Y5 	XS400'80-82 XS750SE'80 XS750 E/F/SF'78-79 XS1100'80 XS1100SE'81
CAB-Y6 	XS650SE'80-81 XS400SE'82 XS650SG'80 XS1100SG'80 XS1100LG/LH/SH'80-81

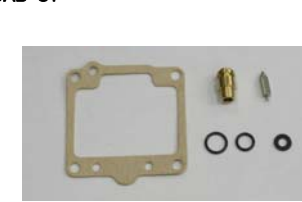
SUZUKI

CAB-S1 	GS550ET/LT/LX/LZ'80-82 GS550MZ'82 GS550TX'81 GS650X/EX/Z/EZ'81-82 GS650GX/GZ/GD'81-83 GS650GLX/GLZ/GLD'81-83 GS650MD KATANA'83 GS850GT/TGX/GZ/GD'80-83 GS850GLT/GLX/GLZ/GLD'80-83 GS1000GT/GLT/GX/GLX'80-81 GS1000ET/ST'80 GSX750LT/LX'80-81 GSX750T/ET/X/EX/EZ'80-82 GSX1100ET/EX/EZ/ED/ESD'80-83 GSX1100LT'80
CAB-S2 	GS550B/C/EC/N/EN/LN'77-79 GS750B/C/EC/N/EN/LN'77-79 GS850GN'79 GS1000C/EC/N/EN/SN/LN'78-79

FUEL PETCOCK REPAIR KIT

FCK-2	kawa	yam
		
KAWASAKI		
KZ650	B3	79
KZ650	F1	80
KZ650	F2-F3	81-82
KZ650	H2/H3	82-83
KZ650	E1	80
KZ1000	K1/K2	81-82
KZ1000	M1/M2	81-82
KZ1000	P1-P14	82-95
YAMAHA		
XS650	F/G/H	79-81
XS650S	E/F/G/H/J/K	78-83
XS750S	E	->311211
XS750S	F	79
XS850S	G/H	80-81

FCK-5		
		
SUZUKI		
GS750L	X	81
GS750T	Z/D	82-83
GS1000GL	X	81
GS1000S	Z	82

FCK-6	kawa	
Diaphragm	1	16126-1038
O ring	1	92055-1068
Spring,dia.	1	92081-1054
O ring,petcock mount	1	43058-1001
Gasket,tap valve	1	11009-1044
Plain washer	2	92022-183
KAWASAKI		
KZ1000	E1/E2	SHAFT 79-80
KZ1000	J1/J2/J3	81-83
KZ1000	A1/A2/A3	SHAFT 81-83
KZ1000	R1/R2	REPLICA 82-83

FCK-8	kawa	
		
KAWASAKI		
KZ900	A4/B1	76
Z1 A/B		73-75
KZ1000	A1	77
KZ1000	B1-B4	LTD 77-80
KZ1000	C1/D1	ZIR 78
KZ1000	D3	ZIR 80

FCK-9	Suz	
		
SUZUKI		
GS750	B/C/N	77-79
GS750E	C/N	78-79
GS1000	C/N	78-79
GS1000E	C/N	78-79
GS1000G	T/X	80-81
GS1000S	N	79

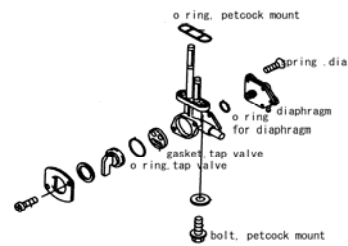

FCK-10	suz	
		
SUZUKI		
GS1000L	N	79

FCK-12	yam	assy ref
Diaphragm	1	diaphragm 2J2-24500-00
O ring for dia.	1	o ring 2H7-24510-00
O ring,petcock mount	1	1J7-24512-00 2H7-24500-00
Gasket,tap valve	1	1J7-24523-00
O ring,tap lever	1	1J7-24534-00
Gasket	1	1J7-24522-00
YAMAHA		
XS650	E	78
XS750	E/E/F	77-79
XS1100	E/F/G/H	78-81

FCK-25		
		
YAMAHA		
XS1100L	G/H	80-81
XS1100S	F/G/H	79-81

FCK-29	kawa	
		
KAWASAKI		
KZ1000	A2-A4	MKII 78-80

Spring, dia. Is not included in the kit.
So, stocked Diaphragm spring should be used.

Each kit contains different parts.
Check details mentioned to order the correct one.

CARB HOLDER KITS

HONDA

CHH-1		CB750FZ/FA/FB/FC/F2C	79-82
CHH-44		CB750K0	70
CHH-45		CB750K1-K5	71-75
		CB750	76
		CB750F	76

YAMAHA

CHY-2		XS650 G/H SPECIAL II	80-81
		XS650 SG/SH SPECIAL	80-81
		XS650 SG/SK HERITAGE SPECIAL	82-83
CHY-3		XS750 F	79
		XS750S E/F	78-79
		XS750SE	80
		XS850 G/H	80-81
		XS850L G/H	80-81
		XS850S G/H	80-81
CHY-5		XS1100	88
		XS1100 E/F/G/H	78-81
		XS1100S G/H	80-81
CHY-27		XS650	80
		XS650 B/C	75-76
		XS650 D	77

KAWASAKI

CHK-1		KZ1000 A1-A4	77-80
		KZ1000 B1-B4 LTD	77-80
		KZ1000 C2-C4	79-81
		KZ1000 D1 Z1R	78
		KZ1000 D3 Z1R	80
		KZ1000 E1-E2 SHAFT	79-80
		KZ900 A4	76
		KZ900 LTD	76
		Z1 /A/B 900	73-75
		KZ650 H2-H3	82-83
		CHK-3	
KZ1000 J3	83		
KZ1000 R2	83		
KZ1100 D2	83		
KZ1100 L1	83		
CHK-7		KZ1000 J1/J2	81-82
		KZ1000 K1/K2 LTD	81-82
		KZ1000 M1/M2 CSR	81-82
		KZ1000 R1 REPLICA	82
CHK-8		KZ1000 J1/J2	81-82
		KZ1000 K1/K2 LTD	81-82
		KZ1000 M1/M2 CSR	81-82
		KZ1000 R1 REPLICA	82

VACUUM VALVE

YAMAHA			VCC-210	VCC-313	VCC-403
VCC-210	XS650J/SK HERITAGE	82-83			
	XS650SG/SH	80-81			
	XS650 G/H SPECIAL II	80-81			
	XS1100G/H	80-81			
	XS1100LG/LH	80-81			
	XS1100SG/SH	80-81			
VCC-221	XS650<1U3>	80-81			
SUZUKI					
VCC-311	GS750E T/X/Z	80-82			
	GS750L T/X	80-81			
VCC-313	GS750T D/Z	82-83			
	GS1000E T	80			
	GS1000H T	80			
	GS1000G T/X	80-81			
	GS1000GL X	81			
KAWASAKI					
VCC-403	KZ1000 J1/J2/J3	81-83			
	KZ1000 R1 REPLICA	82			
	KZ1000 P1	82			
	KZ1000 M1/M2 CSR	81-82			
	KZ1000 LTD K1/K2	81-82			

AIR CUT OFF VALVES

To prevent "after-burn" generated by a lean fuel mixture when closing the throttle, the air cut-off valve temporarily closes the slow-jet air passage and creates an instantly richer mixture.

HONDA

ACV-101



CB750C CUSTOM	80-82
CB750K	80-82
CB750F SUPERSPORT	80-82
CB750SC	82-83

ACV-103



CB750K/L/F	79
CB750FZ	79

CARB PUMP DIAPHRAGM VALVE SET

HONDA

CDV-101

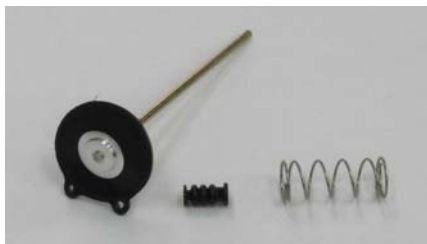

CB750K	77-78
CB750F	77-78
CB750A	76-78

CDV-103





CB750F	79
CB750L	79
CB750K	79-82
CB750C	80-82
CB750CA	80
CB750SC	82-83

VOLTAGE REGULATOR/RECTIFIER

Depending on the market, the different parts might be used in your market.

HONDA

	RGU-104	CB750K	81-82
		CB750C	81-82
		CB750F(B/FC/F2C)	81-82
		CB750SC	82-83
	RGU-105	CB750K	79-80
		CB750L	79
		CB750C	80
		CB750F(Z/A)	79-80
	CB900F(Z/A)	79-80	
	RGU-112	CB750F	75-78
		CB750K	69-78



YAMAHA

	RGU-215	XS750D/2D	77
		XS750E/F	78-79
		XS750SE/SF SPECIAL	78-79
		XS850G/H	80-81
		XS850LG/LH	80-81
		XS850SG/SH SPECIAL	80-81
		XS1100E/F/G/H	78-81
	XS1100SF/SG/SH SPECIAL	79-81	
	XS1100LG/LH MIDNIGHT SPECIAL	80-81	
	RGU-216	XS650G/H SPEC DAIL II	80-81
		XS650SG/SH SPECIAL	80-81
		XS650SJ/SK HERITAGE SPECIAL	82-83

SUZUKI

	RGU-301	GS750ET/EX/EZ	80-82
		GS750LN/LT/LX	79-81
		GS750SD	83
		GS1000ET	80
		GS1000GX/GLX	81
		GS1000ST	80
	GS1000SZ	82	

KAWASAKI

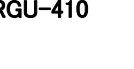
	RGU-401	KZ1000J1/J2/J3	81-83
		KZ1000K1/K2 LTD	81-82
		KZ1000M1/M2 CSR	81-82
	RGU-405	KZ650E1 LTD	80
		KZ650F1	80
	RGU-406	KZ1000A3/A3A/A4 MKII	79-80
		KZ1000B3/B4 LTD	79-80
		KZ1000C2/C3/C4 LTD	79-81
		KZ1000D3 Z1R	80
		KZ1000E1/E2 SHAFT ST	79-80
		KZ1000G1 LTD CLASSIC	80
	RGU-410	KZ6650B2/B2A/B3	78-79
		KZ650C2/C3	78-79
		KZ650D1/D1A/D2 SR	78-79

SILICONE RECTIFIER



STOCK NO	MODEL APPLICATION	
REC-101	CB750SC	82-83
	CB750K	76-82
	CB750L	79
	CB750C CUSTOM	80-82
	CB750F SUPERSPORT	77-82

CAM SHAFT TIMING CHAINS



CMM-A



CMM-G



CMM-Q



CMM-W

CMM-A082	CB750KZ	79
	CB750F	80-82
	CB900FZ	79
	CB900F D/2D	83
	CB900F A/B/2B/C/2C	80-82
	CB1100RB/RC/RD	81-83
	CB1100FD	83
CMM-A098	CBX1000Z/B/C	79-82
	XV750H/J/K/MK	81-83
	XV750SE	82
	XV920RH/RJ	81-82
CMM-A110	XV920J/K/MK	82-83
	CB400A	78-79
	CB400T HAWK	78-80
	CB400TZ	79
	CM400A	79-81
	CM400E	80-81
CMM-A112	CM400T(Z/A/B/C)	79-82
	CB650Z	79
	CB650A/B	79-81
	CB650	80-82
	CB650C	80-81
CMM-A114	CB650SC NIGHTHAWK	82
	KZ400A1-A2 LTD	80-81
	KZ400A3-A4 LTD	82-83
	Z440A1-A3	80-82
	KZ440B1/B2	80-81
	KZ440D2-D5 LTD BELT	80-83
CMM-A120	KZ440G1 BELT	82
	CBX1000Z/B/C	79-82
	XL500R	82
	XL500S/SZ/SA/SB	79-81
CMM-A124	XR500SZ/SA/SB	79-81
	HONDA	
	CB750KZ	79
	CB750F	80-82
	CB750C	80-82
CMM-A126	SUZUKI	
	DR500X/Z/D	81-83
	HONDA	
	CB900FZ	79
	CB900F D/2D	83
	CB900F A/B/2B/C/2C	80-82
	CB1100RB/RC/RD	81-83
CB1100FD	83	
CMM-A128	YAMAHA	
	XT550J/K	82-83
CMM-A134	XLV750R	83
CMM-A134	CBX550FC/F2C/FD/F2D	82-83

CMM-A140	HONDA		
	CB550SC	83	
	KAWASAKI		
	Z400B2-B4	80-82	
	Z400J1-J3	80-83	
	ZR400A1/B1	83-85	
	KZ500B1-B4	79-82	
	KZ550A1-A4	80-83	
	Z550B1/B2	79-80	
	KZ550C1-C4 LTD	80-83	
	Z550D1	81	
CMM-A144	KZ550M1	83	
	Z550H1	82	
	KZ550H2	83	
	CBX650ED/SCD	83	
	CMM-A148	VF750SC/SD SABRE	82-83
	CMM-A150	KZ650H CSR	81-83
		Z650C4	80
		Z650D3	80
		Z650F2-F4	81-83
		KZ650H1/H2	81-82
Z750E1		81	
KZ750F1		83	
Z750H1/H2		81-82	
Z750R1 GP		82	
KZ750L1-L3		81-83	
CMM-A152	KZ1000M1/M2 CSR	81-82	
	KZ1000R1/R2 REPLICA	82-83	
	KZ1000B1/B2	81-82	
	Z1000J1-J3	81-83	
	Z1000K1-K2 LTD	81-82	
	KZ1100A1-A3	81-83	
	KZ1100-D SPECTRE	82-83	
	KZ1100L1 LTD	83	
Z1100B1/B2	81-82		
CMM-A158	KZ1300A1-A3	79-81	
	KZ1300A4-A5	82-83	
	KZ1300B2	80	

CMM-G092	XS400	79-81
CMM-G098	DR400ST/SX	80-81
	GN400TT	80-81
	SP400T	80
CMM-G106	TT5500G/H	79-80
	XS650SE	79-81
	XS650	75-81
CMM-G116	GS550C/EC/N/EN/EX/EZ	77-83
CMM-G118	XVZ12TK/TDK	83
CMM-G120	SUZUKI	
	GS400B/C/EC/N/EN	77-79
	GS425N/EN	78-80
	GS650GTX/GTZ/GTD	81-83
	GS650GX/GZ KATANA	81-82
	GS750LN	79
	GS750E/B/EC/EN	77-79
	GS850GN/GT/GX	79-81
	GS850GLT/GLX	80-81
	GS1000C/EN/EC/N/HN	78-82
	GS1000LN	79
	GS1000GLX	81
	GSX1100(Z/D)	82-83
	GSX1100E(Z/D)	82-83
	GSX1100SZ/SD KATANA	82-83
	GSX1100LT	80
	GSX1100E(T/X)	80-81
YAMAHA		
XJ650T TURBO	82-83	
CMM-G122	GSX750ET/T/EX	80-81
CMM-G124	XS750	78-79
	XS750SE	79-82
CMM-G128	XS1100G/S	78-84
CMM-Q088	CB550K/K1 550 FOUR	76
	CB550F	76-77
	CB550K	77-78
CMM-Q122	Z1 900	73-75
	KZ900B1	76
	KZ900A4/A5	76-77
	Z1000A1/A2	78-79
	Z1000D1	78
CMM-Q124	KZ1000G1	80
	Z1000 MK2	79
	Z1000A3/A4	79-80
	Z1000H1	80
	KZ1000E1/E2	79-80
CMM-Q128	CB500T TWIN DOHC	76
CMM-W088	KZ400C1	78
	KZ400/D	74-75
	KZ400H1	79
CMM-W118	Z650B1/B2/B3	77-79
	Z650D2	79
	KZ650E1	80
	Z650C2/C3	78-79
CMM-W130	KZ750B1-B4	76-79
	KZ750G1	80
	KZ750M1	82

CONTACT POINT SET

DH-34L	CB750K1-K5	71-75
	CB750F	77-78
	CB750A	76-78
DH-34R	SAME AS ABOVE	
DH-40	XS1/B	70-71
	XS650/B/C/D/E	75-79
DK-27L	KZ650B1-B3	77-79
	KZ650C1-C3	77-79
	KZ650D1/D1A/D2	78-79
	KZ650E1	80
	KZ650F1	80
	KZ900A/B1	76
	Z1/A/B	73-75
	KZ1000	77-79
DK-27R	SAME AS ABOVE	
DK-39L	GS750	77
DK-39R	SAME AS ABOVE	
DN-43L	GS750/E	78-79
	GS750LN	79
	GS1000/E	78-80
	GS1000LN/SN	79
DN-43R	SAME AS ABOVE	

CONDENSER







DTO-3	CB750K1-K5	71-75
	CB750F	77-78
	CB750A	76-78
DH0-1	XS750D/2D	77
DHO-1	XS1/B	70-71
	XS650B	75
DKO-2	KZ900A	76-77
	KZ900B	76
	KZ900C	76
	KZ1000A	77-78
	KZ1000B	77-79
	KZ1000D	78
DKO-3	KZ650B1-B3	77-79
	KZ650C1-C3	77-79
	KZ650D1-D2	78-79
	KZ650E1	80
	KZ650F1	80
DKO-2	GS750	77

MUFFLER CONNECTING GASKET

HONDA

NON ASBESTOS

YAMAHA

MCG-101C		
		
GL1000/K1/K2	75-77	C
CB450K5-K7	72-74	C
MCG-102C		
		
CBX	81-82	C D
CBX	79-80	C
CB750F1/F2	77-78	C
MCG-103C		
		
VF750C(C/D/E)MAGNA	82-83	A
VF750S SABRE	82-83	A
XL250S A/B	80-81	C
XL250S Z	79	C
MCG-104C		
		
VF750C(C/D/E) MAGNA	82-83	B
VF750S SABRE	82-83	B
CX650E(D)	83	A
CX650C	83	A
GL650I(D)	83	A
GL650D(D/2D)	83	A
GL500D(D)	82	A
VT500E(D)	83	B D
VT500C(D)	83	A B
GL500(B)	81	A
CX500D(A)	80	A
GL500I(B/C)	81-82	A
CX500A	80	A
CX500B	81	A
MCG-107C		
		
CM400T(Z/A/B)	79-81	A
CM400A(Z/A/B)	79-81	A
CB400N(C)	82	A
CB400N/NA	79-80	A
CB250ND(C)	82	A
CB250N/NA/NB	79-81	A
MCG-108C		
		
GL1000K3/Z	78-79	C D
CX650C	83	B
GL650I(D)	83	B
CX650TD TURBO	83	C
CX650C	83	B
CB650SC(D)	83	D
CX650ED	83	B
CBX650E(D)	83	D
GL650D(D/2D)	83	B
CX500TC(C)	82	B
CX500D(A)	80	B
CX500A	80	B
GL500D SILVERWING	82	B
GL500I(B/C)	81-82	B
GL500(B)	81	B

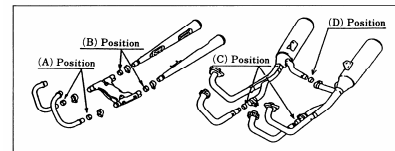

MCG-108C		
GL500D (C)	82	B
CX500B	81	B
CM400T(Z/A/B)	79-81	B
CM400A(Z/A/B)	79-81	B
CB400N/NA	79-80	B
CB400N	82	B
CB250ND	82	B
CB250N/NA/NB	79-81	B
MCG-109C		
		
CB750KZ	79	B
CB650C	80-81	C
MCG-110C		
		
CB1100R(D)	83	D
CB1100F(D)	83	C
CB1100R(C)	82	C D
CB1100R(B)	81	C D
CB900FB	81	C
CB900F2B	81	C
CB900FC/F2C	82	C
CB900FZ/FA	79-80	C
CB750FZ/FA/FB/FC/F2C	79-82	C
CBX550FC/F2C	82	D
CX500C(B/C)	81-82	A
CX500C(A)	80	A
MCG-111C		
		
XR200	80-83	C
XL185SZ/SA/SB	79-81	C
MCG-112C		
		
GL1100A/IA/DA	80	D
GL1100C/IC/DC/AC	82	D
GL1100B/IB/DB	81	D
XL500RC	82	C
FT500 ASCOT	82	B
XL500S/SA	79-80	C
MCG-113C		
		
CX500C(B/C)	81-82	B
CX500C(A)	80	B
MCG-114C		
		
CB1100F(D)	83	D
CB1100F(D)	83	D
CB1000C	83	D
CB900FC/F2C	82	D
CM250CC	82	D

MCG-201		
		
XS1100S	81	C D
XS1100	80-81	C D
XS850	80	C
XS750SE	80	D
XS750SE	78	D
XJ750RJ/RK SECA	82-83	B
XJ650	80-82	B
XT550(5Y5)	82-83	C
XS400	80-82	C
MCG-202C		
		
XV1000 TR1	81-82	C
XV920RH/RJ	81-82	C
XS850G	80	B
XV750K/H/SE	81-83	C
XS750SE	78	C
MCG-203C		
		
XJ750RJ/RK SECA	82-83	A
XJ650 11R.4K0	82	A
XJ650 27G/4K0	83	A
XJ650 27F/4K0	83	A
XJ550	83	A
XJ550	81	A
XJ650H/J	81-82	C
XZ550RJ/RK	82-83	C
MCG-204C		
		
XJ650H/J	81-82	
XZ550RJ/RK	82-83	B
MCG-205C		
		
SR500	78-82	C
MCG-206C		
		
XV1000 TR1	81-82	C D
XS850	80	D
XS750SE	80	C
XS650SE	80-81	D
XS400SE	81-82	D
MCG-207C		
		
XV1000SE	83	C
XV750SE	81-82	C
XT500	78-83	C
MCG-208C		
		
XS750D/E	77-78	C

SUZUKI

MCG-301C		
		
GS650GX/GZ	81-82	C
GS550MX/MZ	81-82	C
GS550D(T)	80	C
GS550E(C/N)	78-79	C
GS550LN	79	C
GS550LT	80	C
GS550(B/C/N)	77-79	C
GSX550E/ES/EF/EU	84-87	C
GSX250Z/EZ/SZ/ESZ	82	C
GSX250T/ET/X/EX	80-81	C
MCG-302C		
		
GS750D(B./C/N)	77-79	C
GS750E(C/N)	78-79	C
GS750B/C/N	77-79	C
MCG-303C		
		
GS850G(N)	79	C
GS850GT/GX	80-81	A B
GS750LN	79	A B
GS400B	77	C
MCG-304C		
		
GS1100LT	80	C
GS1000C/EC/N/EN/ET	78-80	C
GS1000SZ	82	C
GS1000LN	79	C
GS1000H(C/N/T)	78-80	C
GS1000GT/GLT/GX/GLX	80-81	C
GSX750E(T/X/Z)	80-82	C
GSX750LT/LX	80-81	C
GSX750(T/X)	80-81	C
GSX750S(Z)	82	C

KAWASAKI

MCG-401C		
		
KZ1000A1-A2	77-78	D
MCG-402C		
		
KZ1000A1-A2	77-78	B
KZ1000J1/J2	81-82	C D
KZ750R1 GPZ	82	B
MCG-403C		
		
KZ750H1-H4 LTD	80-83	C
KZ750E1-E3	80-82	C
KZ750L1-L2	81-82	C
KZ750R1 GPZ	82	A
KZ550A1-A4	80-83	C
KZ550C1-C4	80-83	C

KAWASAKI

MCG-404C		
		
Z1300A1-A5	79-83	C
KZ750L1-L2	81-82	D
KZ750H1-H4 LTD	80-83	D
KZ750E1-E3	80-82	D
KZ650C2-C3	78-79	C D
KZ650B1-B2	77-78	C D
KZ550A1-A4	80-83	D
KZ550C1-C4	80-83	D
KZ440A1-A3	81-82	D
MCG-405C		
		
Z1300A1-A5	79-83	B

25.4X31.4X25.0	MCG-114C
28.5X32.5X30.0	MCG-203C
28.7X34.5X25.0	MCG-103C
28.7X34.5X34.0	MCG-111C
31.9X37.5X26.0	MCG-401C
32.0X38.0X30.5	MCG-206C
35.0X39.6X32.0	MCG-301C
35.0X41.0X25.0	MCG-102C
35.0X41.0X25.0	MCG-403C
35.0X41.5X32.0	MCG-109C
35.0X42.5X23.0	MCG-207C
37.5X44.0X20.0	MCG-107C
38.0X43.0X25.0	MCG-303C
38.0X44.5X28.0	MCG-110C
38.2X43.5X26.0	MCG-402C
38.2X44.2X24.0	MCG-104C
38.5X42.5X30.0	MCG-204C
38.5X44.5X25.0	MCG-201C
40.5X44.5X25.0	MCG-202C
41.0X47.1X30.0	MCG-304C
41.0X50.0X30.0	MCG-302C
41.2X48.6X34.5	MCG-205C
42.7X48.5X29.0	MCG-101C
42.7X48.6X28.0	MCG-113C
42.8X48.5X30.0	MCG-405C
42.8X48.6X20.0	MCG-108C
42.8X48.6X30.0	MCG-112C
46.5X54.5X25.0	MCG-208C

STARTER CLUTCH REPAIR KIT

SCK-901



ROLLER(15X13) X 3
CAP(6.2 X 15.5) X 3
SPRING X 3

HONDA

CB750F	76-78
CB750F	79-82
CB750K	79-82
CB750L	79
CB750K	76-78
CB750C	80-82
CB750SC	82-83

SUZUKI

GS750B/C	77-78
GS750EC/N/EN/LN	78-79
GS750LT/LX	80-81
GS750ET/EX	80-81
GS750EZ	82
GS750TZ/TD	82-83
GS750SD KATANA	83
GS1000C/EC/N/EN	78-79
GS1000LN/SN	79
GS1000ST/ET	80
GS1000SZ	82

KAWASAKI

KZ650C1-C3	77-79
KZ650D1-D1A/D2	78-79
KZ650B1-B3	77-79
KZ650F1	80
KZ650E1 LTD	80
KZ650H1/H2	81-82

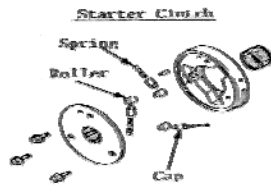

SCK-902



ROLLER(15 X 14.4) X 3
CAP(6.2 X 15.5) X 3
SPRING X 3

KAWASAKI

Z1/A/B/	73-75
KZ900A4/A5	76-77
KZ900B1 LTD	76
KZ1000B1-B3 LTD	77-79
KZ1000D1-D3 Z1R	78-80
KZ1000A1-A4	77-90
KZ1000C1-C4 POLICE	78-81
KZ1000E1/E2 ST & SHAFT	79-80
KZ1000G1 CHASSIS	80
KZ1000J1-J3	81-83
KZ1000K1/K2 CHASSIS	81-82
KZ1000M1/M2 CSR	81-82
KZ1000R1/R2 REPLICA	82-83

SCK-903

ROLLER(15 X 16.9) X 3
CAP(6.2 X 14.1) X 3
SPRING(90501-04503) X 3

YAMAHA

XS850G/SG/LG	80
XS850H/LH/SH	81
XS1100E/F/G/H	78-81
XS1100SF/SG/SH	79-81
XS1100LG/LH MIDNIGHT SPECIAL	80-81



HI PERFORMANCE

CAM CHAIN TENSIONER PUSH ROD KIT

PRK-101



PUSH-ROD	1
HEAVY DUTY SPRING	2
O' RING	1
KZ1000J1-J3	81-83
KZ1000R1/R2	82-83
KZ1000K1/K2	81-82
KZ1000M1/M2	81-82
KZ1000P1/P2	82-83

PRK-102



PUSH ROD	1
HEAVY DUTY SPRING	2
GASKET	1
KZ650H1-H3	81-83